

STATE OF NORTH CAROLINA
DEPARTMENT OF TRANSPORTATION
RALEIGH, N.C.

C204966

CONTRACT AND
CONTRACT BONDS
FOR CONTRACT NO. C204966

WBS 39077.3.2 STATE FUNDED

T.I.P NO. U-4713A

COUNTY OF MECKLENBURG

THIS IS THE ROADWAY & STRUCTURE CONTRACT

ROUTE NUMBER SR-3440 LENGTH 0.912 MILES

LOCATION SR-3440 (MCKEE RD EXT) FROM SR-3448 (PLEASANT PLAINS RD) TO SR-1010 (E JOHN ST).

CONTRACTOR NJR GROUP INC

ADDRESS P.O. BOX 924
ALBEMARLE, NC 28002

BIDS OPENED OCTOBER 15, 2024

CONTRACT EXECUTION 11/04/2024

STATE OF NORTH CAROLINA
DEPARTMENT OF TRANSPORTATION
RALEIGH, N.C.

PROPOSAL

DATE AND TIME OF BID OPENING: **Oct 15, 2024 AT 02:00 PM**

CONTRACT ID C204966
WBS 39077.3.2

FEDERAL-AID NO. STATE FUNDED
COUNTY MECKLENBURG
T.I.P NO. U-4713A
MILES 0.912
ROUTE NO. SR-3440
LOCATION SR-3440 (MCKEE RD EXT) FROM SR-3448 (PLEASANT PLAINS RD) TO SR-1010 (E JOHN ST).

TYPE OF WORK GRADING, DRAINAGE, PAVING, SIGNALS, AND STRUCTURE.

NOTICE:

ALL BIDDERS SHALL COMPLY WITH ALL APPLICABLE LAWS REGULATING THE PRACTICE OF GENERAL CONTRACTING AS CONTAINED IN CHAPTER 87 OF THE GENERAL STATUTES OF NORTH CAROLINA WHICH REQUIRES THE BIDDER TO BE LICENSED BY THE N.C. LICENSING BOARD FOR CONTRACTORS WHEN BIDDING ON ANY NON-FEDERAL AID PROJECT WHERE THE BID IS \$30,000 OR MORE, EXCEPT FOR CERTAIN SPECIALTY WORK AS DETERMINED BY THE LICENSING BOARD. BIDDERS SHALL ALSO COMPLY WITH ALL OTHER APPLICABLE LAWS REGULATING THE PRACTICES OF ELECTRICAL, PLUMBING, HEATING AND AIR CONDITIONING AND REFRIGERATION CONTRACTING AS CONTAINED IN CHAPTER 87 OF THE GENERAL STATUTES OF NORTH CAROLINA. NOTWITHSTANDING THESE LIMITATIONS ON BIDDING, THE BIDDER WHO IS AWARDED ANY FEDERAL - AID FUNDED PROJECT SHALL COMPLY WITH CHAPTER 87 OF THE GENERAL STATUTES OF NORTH CAROLINA FOR LICENSING REQUIREMENTS WITHIN 60 CALENDAR DAYS OF BID OPENING.

BIDS WILL BE RECEIVED AS SHOWN BELOW:

THIS IS A ROADWAY & STRUCTURE PROPOSAL

5% BID BOND OR BID DEPOSIT REQUIRED

**PROPOSAL FOR THE CONSTRUCTION OF
CONTRACT No. C204966 IN MECKLENBURG COUNTY, NORTH CAROLINA
DEPARTMENT OF TRANSPORTATION,
RALEIGH, NORTH CAROLINA**

The Bidder has carefully examined the location of the proposed work to be known as Contract No. **C204966** has carefully examined the plans and specifications, which are acknowledged to be part of the proposal, the special provisions, the proposal, the form of contract, and the forms of contract payment bond and contract performance bond; and thoroughly understands the stipulations, requirements and provisions. The undersigned bidder agrees to bound upon his execution of the bid and subsequent award to him by the Board of Transportation in accordance with this proposal to provide the necessary contract payment bond and contract performance bond within fourteen days after the written notice of award is received by him. The undersigned Bidder further agrees to provide all necessary machinery, tools, labor, and other means of construction; and to do all the work and to furnish all materials, except as otherwise noted, necessary to perform and complete the said contract in accordance with the *2024 Standard Specifications for Roads and Structures* by the dates(s) specified in the Project Special Provisions and in accordance with the requirements of the Engineer, and at the unit or lump sum prices, as the case may be, for the various items given on the sheets contained herein.

The Bidder shall provide and furnish all the materials, machinery, implements, appliances and tools, and perform the work and required labor to construct and complete Contract No. **C204966** in **Mecklenburg County**, for the unit or lump sum prices, as the case may be, bid by the Bidder in his bid and according to the proposal, plans, and specifications prepared by said Department, which proposal, plans, and specifications show the details covering this project, and hereby become a part of this contract.

The published volume entitled *North Carolina Department of Transportation, Raleigh, Standard Specifications for Roads and Structures, January 2024* with all amendments and supplements thereto, is by reference incorporated into and made a part of this contract; that, except as herein modified, all the construction and work included in this contract is to be done in accordance with the specifications contained in said volume, and amendments and supplements thereto, under the direction of the Engineer.

If the proposal is accepted and the award is made, the contract is valid only when signed either by the Contract Officer or such other person as may be designated by the Secretary to sign for the Department of Transportation. The conditions and provisions herein cannot be changed except over the signature of the said Contract Officer.

The quantities shown in the itemized proposal for the project are considered to be approximate only and are given as the basis for comparison of bids. The Department of Transportation may increase or decrease the quantity of any item or portion of the work as may be deemed necessary or expedient.

An increase or decrease in the quantity of an item will not be regarded as sufficient ground for an increase or decrease in the unit prices, nor in the time allowed for the completion of the work, except as provided for the contract.

Accompanying this bid is a bid bond secured by a corporate surety, or certified check payable to the order of the Department of Transportation, for five percent of the total bid price, which deposit is to be forfeited as liquidated damages in case this bid is accepted and the Bidder shall fail to provide the required payment and performance bonds with the Department of Transportation, under the condition of this proposal, within 14 calendar days after the written notice of award is received by him, as provided in the *Standard Specifications*; otherwise said deposit will be returned to the Bidder.



State Contract Officer

Signed by:

Ronald Elton Davenport, Jr.

52C46046381F443...

09/12/2024

TABLE OF CONTENTS

**COVER SHEET
PROPOSAL SHEET**

PROJECT SPECIAL PROVISIONS

HAUL ROADS:..... G-1
CONTRACT TIME AND LIQUIDATED DAMAGES: G-1
INTERMEDIATE CONTRACT TIME NUMBER 1 AND LIQUIDATED DAMAGES: G-1
INTERMEDIATE CONTRACT TIME NUMBER 2 AND LIQUIDATED DAMAGES: G-2
INTERMEDIATE CONTRACT TIME NUMBER 3 AND LIQUIDATED DAMAGES: G-3
CONSTRUCTION MORATORIUM:..... G-4
MAJOR CONTRACT ITEMS: G-4
SPECIALTY ITEMS:..... G-5
FUEL PRICE ADJUSTMENT:..... G-5
STEEL PRICE ADJUSTMENT:..... G-7
SCHEDULE OF ESTIMATED COMPLETION PROGRESS:..... G-18
MINORITY BUSINESS ENTERPRISE AND WOMEN BUSINESS ENTERPRISE:..... G-18
RESTRICTIONS ON ITS EQUIPMENT AND SERVICES:..... G-35
USE OF UNMANNED AIRCRAFT SYSTEM (UAS): G-35
EQUIPMENT IDLING GUIDELINES:..... G-35
SUBSURFACE INFORMATION:..... G-36
MAINTENANCE OF THE PROJECT: G-36
COOPERATION BETWEEN CONTRACTORS:..... G-37
TWELVE MONTH GUARANTEE:..... G-37
OUTSOURCING OUTSIDE THE USA:..... G-38
EROSION AND SEDIMENT CONTROL/STORMWATER CERTIFICATION:..... G-38
PROCEDURE FOR MONITORING BORROW PIT DISCHARGE:..... G-43
NOTES TO CONTRACTOR: G-45

ROADWAY.....R-1

STANDARD SPECIAL PROVISIONS

AVAILABILITY OF FUNDS – TERMINATION OF CONTRACTSSSP-1
NCDOT GENERAL SEED SPECIFICATION FOR SEED QUALITYSSP-2
ERRATA.....SSP-5
PLANT AND PEST QUARANTINESSSP-6
MINIMUM WAGESSSP-7
TITLE VI AND NONDISCRIMINATION:SSP-8
ON-THE-JOB TRAININGSSP-17

UNIT PROJECT SPECIAL PROVISIONS

PAVEMENT MARKINGS PM-1
TRAFFIC CONTROL TC-1
UTILITY CONSTRUCTION.....UC-1

UTILITY BY OTHERS..... UBO-1
EROSION CONTROL EC-1
TRAFFIC SIGNALS TS-1
STRUCTURE/CULVERTS ST-1

PERMITS P-1

PROPOSAL ITEM SHEET

ITEM SHEET(S)

PROJECT SPECIAL PROVISIONS**GENERAL****HAUL ROADS:**

(7-16-24)

105

SP1 G04

Revise the *Standard Specifications* as follows:

Page 1-45, Article 105-15 RESTRICTION OF LOAD LIMITS, line 31, add the following after second sentence of the second paragraph:

At least 30 days prior to use, the Contractor shall notify the Engineer of any public road proposed for use as a haul road for the project.

CONTRACT TIME AND LIQUIDATED DAMAGES:

(4-17-12)(Rev. 5-16-23)

108

SP1 G08 A

The date of availability for this contract is **December 2, 2024 (for tree clearing operations only), except February 3, 2025 (for all other operations)**, except that work in jurisdictional waters and wetlands shall not begin until a meeting between the DOT, Regulatory Agencies, and the Contractor is held as stipulated in the permits contained elsewhere in this proposal. This delay in availability has been considered in determining the contract time for this project.

The completion date for this contract is **March 30, 2027**.

Except where otherwise provided by the contract, observation periods required by the contract will not be a part of the work to be completed by the completion date and/or intermediate contract times stated in the contract. The acceptable completion of the observation periods that extend beyond the final completion date shall be a part of the work covered by the performance and payment bonds.

The liquidated damages for this contract are **Two Hundred Dollars (\$200.00)** per calendar day. These liquidated damages will not be cumulative with any liquidated damages which may become chargeable under Intermediate Contract Time Number 1.

INTERMEDIATE CONTRACT TIME NUMBER 1 AND LIQUIDATED DAMAGES:

(7-1-95) (Rev. 2-21-12)

108

SP1 G13 A

Except for that work required under the Project Special Provisions entitled *Planting, Reforestation* and/or *Permanent Vegetation Establishment*, included elsewhere in this proposal, the Contractor will be required to complete all work included in this contract and shall place and maintain traffic on same.

The date of availability for this intermediate contract time is **December 2, 2024 (for tree clearing operations only), except February 3, 2025 (for all other operations)**.

The completion date for this intermediate contract time is **October 1, 2026**.

The liquidated damages for this intermediate contract time are **Two Thousand Dollars (\$ 2,000.00)** per calendar day.

Upon apparent completion of all the work required to be completed by this intermediate date, a final inspection will be held in accordance with Article 105-17 and upon acceptance, the Department will assume responsibility for the maintenance of all work except *Planting, Reforestation* and/or *Permanent Vegetation Establishment*. The Contractor will be responsible for and shall make corrections of all damages to the completed roadway caused by his planting operations, whether occurring prior to or after placing traffic through the project.

INTERMEDIATE CONTRACT TIME NUMBER 2 AND LIQUIDATED DAMAGES:

(2-20-07)

108

SP1 G14 A

The Contractor shall complete the required work of installing, maintaining, and removing the traffic control devices for lane closures and restoring traffic to the existing traffic pattern. The Contractor shall not close or narrow a lane of traffic on **McKee Road (-L-) and/or Pleasant Plains Road (-Y1-)** during the following time restrictions:

DAY AND TIME RESTRICTIONS

Monday thru Friday, 6:00 A.M. to 9:00 A.M. and 4:00 P.M. to 7:00 P.M.

In addition, the Contractor shall not close or narrow a lane of traffic on **McKee Road (-L-) and/or Pleasant Plains Road (-Y1-)**, detain and/or alter the traffic flow on or during holidays, holiday weekends, special events, or any other time when traffic is unusually heavy, including the following schedules:

HOLIDAY AND HOLIDAY WEEKEND LANE CLOSURE RESTRICTIONS

1. For **any occurrence** that creates unusually high traffic volumes, as directed by the Engineer.
2. For **New Year's Day**, between the hours of **6:00 A.M.** December 31st and **7:00 P.M.** January 2nd. If New Year's Day is on a Friday, Saturday, Sunday or Monday, then until **7:00 P.M.** the following Tuesday.
3. For **Easter**, between the hours of **6:00 A.M.** Thursday and **7:00 P.M.** Monday.
4. For **Memorial Day**, between the hours of **6:00 A.M.** Friday and **7:00 P.M.** Tuesday.
5. For **Independence Day**, between the hours of **6:00 A.M.** the day before Independence Day and **7:00 P.M.** the day after Independence Day.

If **Independence Day** is on a Friday, Saturday, Sunday or Monday, then between the hours of **6:00 A.M.** the Thursday before Independence Day and **7:00 P.M.** the Tuesday after Independence Day.
6. For **Labor Day**, between the hours of **6:00 A.M.** Friday and **7:00 P.M.** Tuesday.

7. For **Thanksgiving**, between the hours of **6:00 A.M.** Tuesday and **7:00 P.M.** Monday.
8. For **Christmas**, between the hours of **6:00 A.M.** the Friday before the week of Christmas Day and **7:00 P.M.** the following Tuesday after the week of Christmas Day.

Holidays and holiday weekends shall include New Year's, Easter, Memorial Day, Independence Day, Labor Day, Thanksgiving, and Christmas. The Contractor shall schedule his work so that lane closures will not be required during these periods, unless otherwise directed by the Engineer.

The time of availability for this intermediate contract work shall be the time the Contractor begins to install all traffic control devices for lane closures according to the time restrictions listed herein.

The completion time for this intermediate contract work shall be the time the Contractor is required to complete the removal of all traffic control devices for lane closures according to the time restrictions stated above and place traffic in the existing traffic pattern.

The liquidated damages are **Two Hundred Fifty Dollars (\$ 250.00)** per hour.

INTERMEDIATE CONTRACT TIME NUMBER 3 AND LIQUIDATED DAMAGES:

(2-20-07)

108

SP1 G14 A

The Contractor shall complete the required work of installing, maintaining, and removing the traffic control devices for lane closures and restoring traffic to the existing traffic pattern. The Contractor shall not close or narrow a lane of traffic on **East John Street (-Y5-)** during the following time restrictions:

DAY AND TIME RESTRICTIONS

Monday thru Friday, 6:00 A.M. to 9:00 A.M. and 4:00 P.M. to 7:00 P.M.

In addition, the Contractor shall not close or narrow a lane of traffic on **East John Street (-Y5-)**, detain and/or alter the traffic flow on or during holidays, holiday weekends, special events, or any other time when traffic is unusually heavy, including the following schedules:

HOLIDAY AND HOLIDAY WEEKEND LANE CLOSURE RESTRICTIONS

1. For **any occurrence** that creates unusually high traffic volumes, as directed by the Engineer.
2. For **New Year's Day**, between the hours of **6:00 A.M.** December 31st and **7:00 P.M.** January 2nd. If New Year's Day is on a Friday, Saturday, Sunday or Monday, then until **7:00 P.M.** the following Tuesday.
3. For **Easter**, between the hours of **6:00 A.M.** Thursday and **7:00 P.M.** Monday.
4. For **Memorial Day**, between the hours of **6:00 A.M.** Friday and **7:00 P.M.** Tuesday.

5. For **Independence Day**, between the hours of **6:00 A.M.** the day before Independence Day and **7:00 P.M.** the day after Independence Day.

If **Independence Day** is on a Friday, Saturday, Sunday or Monday, then between the hours of **6:00 A.M.** the Thursday before Independence Day and **7:00 P.M.** the Tuesday after Independence Day.

6. For **Labor Day**, between the hours of **6:00 A.M.** Friday and **7:00 P.M.** Tuesday.
7. For **Thanksgiving**, between the hours of **6:00 A.M.** Tuesday and **7:00 P.M.** Monday.
8. For **Christmas**, between the hours of **6:00 A.M.** the Friday before the week of Christmas Day and **7:00 P.M.** the following Tuesday after the week of Christmas Day.

Holidays and holiday weekends shall include New Year's, Easter, Memorial Day, Independence Day, Labor Day, Thanksgiving, and Christmas. The Contractor shall schedule his work so that lane closures will not be required during these periods, unless otherwise directed by the Engineer.

The time of availability for this intermediate contract work shall be the time the Contractor begins to install all traffic control devices for lane closures according to the time restrictions listed herein.

The completion time for this intermediate contract work shall be the time the Contractor is required to complete the removal of all traffic control devices for lane closures according to the time restrictions stated above and place traffic in the existing traffic pattern.

The liquidated damages are **Three Hundred Fifty Dollars (\$ 350.00)** per fifteen (15) minute time period.

CONSTRUCTION MORATORIUM:

(1-19-16)

SP1 G18C

No tree cutting will be allowed from **April 1st** through **October 15th** of any year.

MAJOR CONTRACT ITEMS:

(2-19-02)(Rev. 1-16-24)

104

SP1 G28

The following listed items are the major contract items for this contract (see Article 104-5 of the *Standard Specifications*):

Line #	Description
3	Unclassified Excavation
27	Aggregate Base Course
32	Asphalt Conc Intermediate Course, Type I19.0C
107	16" Water Line
211	Sound Barrier Wall

SPECIALTY ITEMS:

(7-1-95)(Rev. 1-16-24)

108-6

SP1 G37

Items listed below will be the specialty items for this contract (see Article 108-6 of the *Standard Specifications*).

Line #	Description
63-68	Guardrail
69	Fencing
73-77	Signing
91-94, 103	Long-Life Pavement Markings
201 or 202 or 203 or 204 or 205	Permanent Pavement Markers
104	Lighting
105-127	Utility Construction
128-164	Erosion Control
165-200	Signals/ITS System

FUEL PRICE ADJUSTMENT:

(11-15-05)(Rev. 1-16-24)

109-8

SP1 G43

Page 1-82, Article 109-8, FUEL PRICE ADJUSTMENTS, add the following:

The base index price for DIESEL #2 FUEL is \$ **2.3222** per gallon. Where any of the following are included as pay items in the contract, they will be eligible for fuel price adjustment.

The pay items and the fuel factor used in calculating adjustments to be made will be as follows:

Description	Units	Fuel Usage Factor Diesel
Unclassified Excavation	Gal/CY	0.29
Borrow Excavation	Gal/CY	0.29
Class IV Subgrade Stabilization	Gal/Ton	0.55
Aggregate Base Course	Gal/Ton	0.55
Sub-Ballast	Gal/Ton	0.55
Erosion Control Stone	Gal/Ton	0.55
Rip Rap, Class _____	Gal/Ton	0.55
Asphalt Concrete Base Course, Type _____	Gal/Ton	0.90 or 2.90
Asphalt Concrete Intermediate Course, Type _____	Gal/Ton	0.90 or 2.90
Asphalt Concrete Surface Course, Type _____	Gal/Ton	0.90 or 2.90
Open-Graded Asphalt Friction Course	Gal/Ton	0.90 or 2.90
Permeable Asphalt Drainage Course, Type _____	Gal/Ton	0.90 or 2.90
Sand Asphalt Surface Course, Type _____	Gal/Ton	0.90 or 2.90
Ultra-thin Bonded Wearing Course	Gal/Ton	0.90 or 2.90
Aggregate for Cement Treated Base Course	Gal/Ton	0.55
Portland Cement for Cement Treated Base Course	Gal/Ton	0.55
> 11" Portland Cement Concrete Pavement	Gal/SY	0.327
Concrete Shoulders Adjacent to > 11" Pavement	Gal/SY	0.327
9" to 11" Portland Cement Concrete Pavement	Gal/SY	0.272
Concrete Shoulders Adjacent to 9" to 11" Pavement	Gal/SY	0.272
< 9" Portland Cement Concrete Pavement	Gal/SY	0.245
Concrete Shoulders Adjacent to < 9" Pavement	Gal/SY	0.245

For the asphalt items noted in the chart as eligible for fuel adjustments, the bidder may include the *Fuel Usage Factor Adjustment Form* with their bid submission if they elect to use the fuel usage factor. The *Fuel Usage Factor Adjustment Form* is found at the following link:

<https://connect.ncdot.gov/letting/LetCentral/Fuel%20Usage%20Factor%20Adjustment%20Form%20-%20Starting%20Nov%202022%20Lettings.pdf>

Select either 2.90 Gal/Ton fuel factor or 0.90 Gal/Ton fuel factor for each asphalt line item on the *Fuel Usage Factor Adjustment Form*. The selected fuel factor for each asphalt item will remain in effect for the duration of the contract.

Failure to complete the *Fuel Usage Factor Adjustment Form* will result in using 2.90 gallons per ton as the Fuel Usage Factor for Diesel for the asphalt items noted above. The contractor will not be permitted to change the Fuel Usage Factor after the bids are submitted.

STEEL PRICE ADJUSTMENT:

(4-19-22)(Rev. 12-20-22)

SP1 G47

Description and Purpose

Steel price adjustments will be made to the payments due the Contractor for items as defined herein that are permanently incorporated into the work, when the price of raw steel mill products utilized on the contract have fluctuated. The Department will adjust monthly progress payments up or down as appropriate for cost changes in steel according to this provision.

Eligible Items

The list of eligible bid items for steel price adjustment can be found on the Departments website at the following address:

<https://connect.ncdot.gov/letting/LetCentral/Eligible%20Bid%20Items%20for%20Steel%20Price%20Adjustment.xlsx>

Nuts, bolts, anchor bolts, rebar chairs, connecting bands and other miscellaneous hardware associated with these items shall not be included in the price adjustment.

Adjustments will only be made for fluctuations in the material cost of the steel used in the above products as specified in the Product Relationship Table below. The producing mill is defined as the source of steel product before any fabrication has occurred (e.g., coil, plate, rebar, hot rolled shapes, etc.). No adjustment will be made for changes in the cost of fabrication, coating, shipping, storage, etc.

No steel price adjustments will be made for any products manufactured from steel having an adjustment date, as defined by the Product Relationship Table below, prior to the letting date.

Bid Submittal Requirements

The successful bidder, within 14 calendar days after the notice of award is received by him, shall provide the completed Form SPA-1 to the Department (State Contract Officer or Division Contract Engineer) along with the payment bonds, performance bonds and contract execution signature sheets in a single submittal. If Form SPA-1 is not included in the same submittal as the payment bonds, performance bonds and contract execution signature sheets, the Contractor will not be eligible for any steel price adjustment for any item in the contract for the life of the contract. Form SPA-1 can be found on the Department's website at the following address:

<https://connect.ncdot.gov/letting/LetCentral/Form%20SPA-1.xlsm>

The Contractor shall provide Form SPA-1 listing the Contract Line Number, (with corresponding Item Number, Item Description, and Category) for the steel products they wish to have an adjustment calculated. Only the contract items corresponding to the list of eligible item numbers for steel price adjustment may be entered on Form SPA-1. The Contractor may choose to have steel price adjustment applied to any, all, or none of the eligible items. However, the Contractor's selection of items for steel price adjustment or non-selection (non-participation)

may not be changed once Form SPA-1 has been received by the Department. Items the Bidder chooses for steel price adjustment must be designated by writing the word “Yes” in the column titled “Option” by each Pay Item chosen for adjustment. Should the bidder elect an eligible steel price item, the entire quantity of the line item will be subject to the price adjustment for the duration of the Contract. The Bidder’s designations on Form SPA-1 must be written in ink or typed and signed by the Bidder (Prime Contractor) to be considered complete. Items not properly designated, designated with “No”, or left blank on the Bidder’s Form SPA-1 will automatically be removed from consideration for adjustment. No steel items will be eligible for steel price adjustment on this Project if the Bidder fails to return Form SPA-1 in accordance with this provision.

Establishing the Base Price

The Department will use a blend of monthly average prices as reported from the Fastmarkets platform to calculate the monthly adjustment indices (BI and MI). This data is typically available on the first day of the month for the preceding month. The indices will be calculated by the Department for the different categories found on the Product Relationship Table below. For item numbers that include multiple types of steel products, the category listed for that item number will be used for adjusting each steel component.

The bidding index for Category 1 Steel items is **\$ 37.50** per hundredweight.
 The bidding index for Category 2 Steel items is **\$ 49.34** per hundredweight.
 The bidding index for Category 3 Steel items is **\$ 60.68** per hundredweight.
 The bidding index for Category 4 Steel items is **\$ 37.06** per hundredweight.
 The bidding index for Category 5 Steel items is **\$ 52.19** per hundredweight.
 The bidding index for Category 6 Steel items is **\$ 49.77** per hundredweight.
 The bidding index for Category 7 Steel items is **\$ 39.60** per hundredweight.

The bidding index represents a selling price of steel based on Fastmarkets data for the month of **August 2024**.

- MI = Monthly Index. – in Dollars (\$) per hundredweight (CWT). Use the adjustment indices from the month the steel was shipped from the producing mill, received on the project, or member cast as defined in the Product Relationship Table.
- BI = Bidding Index. - in Dollars (\$) per hundredweight (CWT). Use the adjustment indices as listed in the proposal.

<i>Product Relationship Table</i>			
<i>Steel Product (Title)</i>	BI, MI*	Adjustment Date for MI	Category
Reinforcing Steel, Bridge Deck, and SIP Forms	Based on one or more Fastmarkets indices	Delivery Date from Producing Mill	1
Structural Steel and Encasement Pipe	Based on one or more Fastmarkets indices	Delivery Date from Producing Mill	2
Steel H-Piles, Soldier Pile Walls	Based on one or more Fastmarkets indices	Delivery Date from Producing Mill	3
Guardrail Items and Pipe	Based on one or more	Material Received Date**	4

Piles	Fastmarkets indices		
Fence Items	Based on one or more Fastmarkets indices	Material Received Date**	5
Overhead Sign Assembly, Signal Poles, High Mount Standards	Based on one or more Fastmarkets indices	Material Received Date**	6
Prestressed Concrete Members	Based on one or more Fastmarkets indices	Cast Date of Member	7
* BI and MI are in converted units of Dollars per Hundredweight (\$/CWT)			
** Material Received Date is defined as the date the materials are received on the project site. If a material prepayment is made for a Category 4-6 item, the Adjustment Date to be used will be the date of the prepayment request instead of the Materials Received Date.			

Submit documentation to the Engineer for all items listed in the Contract for which the Contractor is requesting a steel price adjustment.

Submittal Requirements

The items in categories 1,2, and 3, shall be specifically stored, labeled, or tagged, recognizable by color marking, and identifiable by Project for inspection and audit verification immediately upon arrival at the fabricator.

Furnish the following documentation for all steel products to be incorporated into the work and documented on Form SPA-2, found on the Departments website at the following address:

<https://connect.ncdot.gov/projects/construction/Construction%20Forms/Form%20SPA-2.xlsx>

Submit all documentation to the Engineer prior to incorporation of the steel into the completed work. The Department will withhold progress payments for the affected contract line item if the documentation is not provided and at the discretion of the Engineer the work is allowed to proceed. Progress payments will be made upon receipt of the delinquent documentation.

Step 1 (Form SPA -2)

Utilizing Form SPA-2, submit separate documentation packages for each line item from Form SPA-1 for which the Contractor opted for a steel price adjustment. For line items with multiple components of steel, each component should be listed separately. Label each SPA-2 documentation package with a unique number as described below.

- a. Documentation package number: (Insert the contract line-item) - (Insert sequential package number beginning with "1").

Example: 412 - 1,
412 - 2,
424 - 1,
424 - 2,
424 - 3, etc.

- b. The steel product quantity in pounds

- i. The following sources should be used, in declining order of precedence, to determine the weight of steel/iron, based on the Engineers decision:
 1. Department established weights of steel/iron by contract pay item per pay unit;
 2. Approved Shop Drawings;
 3. Verified Shipping Documents;
 4. Contract Plans;
 5. Standard Drawing Sheets;
 6. Industry Standards (i.e., AISC Manual of Steel Construction, AWWA Standards, etc.); and
 7. Manufacture's data.
- ii. Any item requiring approved shop drawings shall have the weights of steel calculated and shown on the shop drawings or submitted and certified separately by the fabricator.
- c. The date the steel product, subject to adjustment, was shipped from the producing mill (Categories 1-3), received on the project (Categories 4-6), or casting date (Category 7).

Step 2 (Monthly Calculator Spreadsheet)

For each month, upon the incorporation of the steel product into the work, provide the Engineer the following:

- 1) Completed NCDOT Steel Price Adjustment Calculator Spreadsheet, summarizing all the steel submittal packages (Form SPA-2) actually incorporated into the completed work in the given month.
 - a. Contract Number
 - b. Bidding Index Reference Month
 - c. Contract Completion Date or Revised Completion Date
 - d. County, Route, and Project TIP information
 - e. Item Number
 - f. Line-Item Description
 - g. Submittal Number from Form SPA-2
 - h. Adjustment date
 - i. Pounds of Steel
- 2) An affidavit signed by the Contractor stating the documentation provided in the NCDOT Steel Price Adjustment Calculator Spreadsheet is true and accurate.

Price Adjustment Conditions

Download the Monthly Steel Adjustment Spreadsheet with the most current reference data from the Department's website each month at the following address:

<https://connect.ncdot.gov/projects/construction/Construction%20Forms/Form%20SPA-3%20NCDOT%20Steel%20Price%20Adjustment%20Calculator.xlsx>

If the monthly Fastmarkets data is not available, the data for the most recent immediately preceding month will be used as the basis for adjustment.

Price Adjustment Calculations

The price adjustment will be determined by comparing the percentage of change in index value listed in the proposal (BI) to the monthly index value (MI). (See included sample examples). Weights and date of shipment must be documented as required herein. The final price adjustment dollar value will be determined by multiplying this percentage increase or decrease in the index by the represented quantity of steel incorporated into the work, and the established bidding index (BI) subject to the limitations herein.

Price increase/decrease will be computed as follows:

$$\text{SPA} = ((\text{MI} / \text{BI}) - 1) * \text{BI} * (\text{Q} / 100)$$

Where;

SPA = Steel price adjustment in dollars

MI = Monthly Shipping Index. – in Dollars (\$) per hundredweight (CWT). Use the adjustment indices from the month the steel was shipped from the producing mill, received on the project, or member cast as defined in the Product Relationship Table.

BI = Bidding Index. - in Dollars (\$) per hundredweight (CWT). Use the adjustment indices as listed in the proposal.

Q = Quantity of steel, product, pounds actually incorporated into the work as documented by the Contractor, or Design Build Team and verified by the Engineer.

Calculations for price adjustment shall be shown separate from the monthly progress estimate and will not be included in the total cost of work for determination of progress or for extension of Contract time in accordance with Subarticle 108-10(B)(1).

Any apparent attempt to unbalance bids in favor of items subject to price adjustment may result in rejection of the bid proposal.

Adjustments will be paid or charged to the Contractor only. Any Contractor receiving an adjustment under this provision shall distribute the proper proportional part of such adjustments to the subcontractor who performed the applicable work.

Delays to the work caused by steel shortages may be justification for a Contract time extension but will not constitute grounds for claims for standby equipment, extended office overhead, or other costs associated with such delays.

If an increase in the steel material price is anticipated to exceed 50% of the original quoted price, the contractor must notify the Department within 7 days prior to purchasing the material. Upon receipt of such notification, the Department will direct the Contractor to either (1) proceed with the work or (2) suspend the work and explore the use of alternate options.

If the decrease in the steel material exceeds 50% of the original quoted price, the contractor may submit to the Department additional market index information specific to the item in question to dispute the decrease. The Department will review this information and determine if the decrease is warranted.

When the steel product adjustment date, as defined in the Product Relationship Table, is after the approved contract completion date, the steel price adjustments will be based on the lesser value of either the MI for the month of the approved contract completion date or the MI for the actual adjustment date.

If the price adjustment is based on estimated material quantities for that time, and a revision to the total material quantity is made in a subsequent or final estimate, an appropriate adjustment will be made to the price adjustment previously calculated. The adjustment will be based on the same indices used to calculate the price adjustment which is being revised. If the adjustment date of the revised material quantity cannot be determined, the adjustment for the quantity in question, will be based on the indices utilized to calculate the steel price adjustment for the last initial documentation package submission, for the steel product subject to adjustment, that was incorporated into the particular item of work, for which quantities are being finalized.

Example: Structural steel for a particular bridge was provided for in three different shipments with each having a different mill shipping date. The quantity of structural steel actually used for the bridge was calculated and a steel price adjustment was made in a progress payment. At the conclusion of the work an error was found in the plans of the final quantity of structural steel used for the bridge. The quantity to be adjusted cannot be directly related to any one of the three mill shipping dates. The steel price adjustment for the quantity in question would be calculated using the indices that were utilized to calculate the steel price adjustment for the quantity of structural steel represented by the last initial structural steel documentation package submission. The package used will be the one with the greatest sequential number.

Extra Work/Force Account:

When steel products, as specified herein, are added to the contract as extra work, in accordance with the provisions of Article 104-7 or 104-3, the Engineer will determine and specify in the supplemental agreement, the need for application of steel price adjustments on a case-by-case basis. No steel price adjustments will be made for any products manufactured from steel having an adjustment date prior to the supplemental agreement execution date. Price adjustments will be made as provided herein, except the Bidding Index will be based on the month in which the supplemental agreement pricing was executed.

For work performed on force account basis, reimbursement of actual material costs, along with the specified overhead and profit markup, will be considered to include full compensation for the current cost of steel and no steel price adjustments will be made.

Examples Form SPA-2

Steel Price Adjustment Submission Form

Contract Number C203394 Bid Reference Month January 2019

Submittal Date 8/31/2019

Contract Line Item 237

Line Item Description APPROX....LBS Structural Steel

Sequential Submittal Number 2

Supplier	Description of material	Location information	Quantity in lbs.	Adjustment Date
XYZ mill	Structural Steel	Structure 3, Spans A-C	1,200,000	May 4, 2020
ABC distributing	Various channel & angle shapes	Structure 3 Spans A-C	35,000	July 14, 2020
		Total Pounds of Steel	1,235,000	

- Note: Attach the following supporting documentation to this form.
- Bill of Lading to support the shipping dates
 - Supporting information for weight documentation (e.g., Pay item reference, Shop drawings, shipping documents, Standards Sheets, industry standards, or manufacturer's data)

By providing this data under my signature, I attest to the accuracy of and validity of the data on this form and certify that no deliberate misrepresentation in any manner has occurred.

Printed Name

Signature

Examples Form SPA-2
Steel Price Adjustment Submission Form

Contract Number C203394 Bid Reference Month January 2019

Submittal Date August 31, 2019

Contract Line Item 237

Line Item Description SUPPORT, OVRHD SIGN STR -DFEB – STA 36+00

Sequential Submittal Number 2

Supplier	Description of material	Location information	Quantity in lbs.	Adjustment Date
XYZ mill	Tubular Steel (Vertical legs)	<u>-DFEB – STA 36+00</u>	12000	December 11, 2021
PDQ Mill	4" Tubular steel (Horizontal legs)	<u>-DFEB – STA 36+00</u>	5900	December 11, 2021
ABC distributing	Various channel & angle shapes (see quote)	<u>-DFEB – STA 36+00</u>	1300	December 11, 2021
	Catwalk assembly	<u>-DFEB – STA 36+00</u>	2000	December 11, 2021
Nucor	Flat plate	<u>-DFEB – STA 36+00</u>	650	December 11, 2021
		Total Pounds of Steel	21,850	

Note: Attach the following supporting documentation to this form.

- Bill of Lading to support the shipping dates
- Supporting information for weight documentation (e.g., Pay item reference, Shop drawings, shipping documents, Standards Sheets, industry standards, or manufacturer's data)

By providing this data under my signature, I attest to the accuracy of and validity of the data on this form and certify that no deliberate misrepresentation in any manner has occurred.

Printed Name

Signature

Price Adjustment Sample Calculation (increase)

Project bid on September 17, 2019

Line Item 635 "Structural Steel" has a plan quantity of 2,717,000 lbs.

Bidding Index for Structural Steel (Category 2) in the proposal was \$36.12/CWT = BI

450,000 lbs. of Structural Steel for Structure 2 at Station 44+08.60 were shipped to fabricator from the producing mill in same month, May 2021.

Monthly Index for Structural Steel (Category 2) for May 2021 was \$64.89/CWT = MI

The Steel Price Adjustment formula is as follows:

$$\text{SPA} = ((\text{MI} / \text{BI}) - 1) * \text{BI} * (\text{Q} / 100)$$

Where; SPA = Steel price adjustment in dollars

BI = Bidding Index – in dollars (\$) per hundredweight (CWT). Use the adjustment indices as listed in the proposal.

MI = Mill Shipping Index – in dollars (\$) per hundredweight (CWT). Use the adjustment indices from the month the steel was shipped from the producing mill, received on the project, or member cast as defined in the Product Relationship Table.

Q = Quantity of steel product, in pounds (lbs.) actually incorporated into the work as documented by the Contractor, or Design Build Team and verified by the Engineer.

$$\text{BI} = \$36.12 / \text{CWT}$$

$$\text{MI} = \$64.89 / \text{CWT}$$

$$\% \text{ change} = ((\text{MI} / \text{BI}) - 1) = (\$64.89 / \$36.12 - 1) = (1.79651 - 1) = 0.79651162791$$

$$\text{Q} = 450,000 \text{ lbs.}$$

$$\text{SPA} = 0.79651162791 \times \$36.12 \times (450,000 / 100)$$

$$\text{SPA} = 0.79651162791 * \$36.12 * 4,500$$

$$\text{SPA} = \$129,465 \text{ pay adjustment to Contractor for Structural Steel (Structure 2 at Station 44+08.60)}$$

Price Adjustment Sample Calculation (decrease)

Project bid on December 18, 2018

Line Item 635 Structural Steel has a plan quantity of 2,717,000 lbs.

Bidding Index for Structural Steel (Category 2) in the proposal was \$46.72/CWT = BI

600,000 lbs. of Structural Steel for Structure 1 at Station 22+57.68 were shipped to fabricator from the producing mill in same month, August 2020.

Monthly Index for Structural Steel (Category 2) for August 2020 was \$27.03/CWT = MI

The Steel Price Adjustment formula is as follows:

$$\text{SPA} = ((\text{MI} / \text{BI}) - 1) * \text{BI} * (\text{Q} / 100)$$

Where; SPA = Steel price adjustment in dollars

BI = Bidding Index – in dollars (\$) per hundredweight (CWT). Use the adjustment indices as listed in the proposal.

MI = Mill Shipping Index – in dollars (\$) per hundredweight (CWT). Use the adjustment indices from the month the steel was shipped from the producing mill, received on the project, or member cast as defined in the Product Relationship Table.

Q = Quantity of steel product, in pounds (lbs.) actually incorporated into the work as documented by the Contractor, or Design Build Team and verified by the Engineer.

$$\text{BI} = \$46.72 / \text{CWT}$$

$$\text{MI} = \$27.03 / \text{CWT}$$

$$\% \text{ change} = ((\text{MI} / \text{BI}) - 1) = (\$27.03 / \$46.72 - 1) = (0.57855 - 1) = -0.421446917808$$

$$\text{Q} = 600,000 \text{ lbs.}$$

$$\text{SPA} = -0.421446917808 * \$46.72 * (600,000 / 100)$$

$$\text{SPA} = -0.421446917808 * \$46.72 * 6,000$$

$$\text{SPA} = \$ 118,140.00 \text{ Credit to the Department for Structural Steel (Structure 1 at Station 22+57.68)}$$

Price Adjustment Sample Calculation (increase)

Project bid on July 16, 2020

Line Item 614 Reinforced Concrete Deck Slab has a plan quantity of 241974 lbs.

Bidding Index Reference Month was May 2020. Bidding Index for Reinforced Concrete Deck Slab (Category 1) in the proposal was \$29.21/CWT = BI

51,621 lbs. of reinforcing steel and 52,311 lbs. of epoxy coated reinforcing steel for Structure 2 at Station 107+45.55 -L- was shipped to fabricator from the producing mill in same month, May 2021.

Monthly Index for Reinforced Concrete Deck Slab (Category 1) for May 2021 was \$43.13/CWT = MI

The Steel Price Adjustment formula is as follows:

$$\text{SPA} = ((\text{MI} / \text{BI}) - 1) * \text{BI} * (\text{Q} / 100)$$

Where; SPA = Steel price adjustment in dollars

BI = Bidding Index – in dollars (\$) per hundredweight (CWT). Use the adjustment indices as listed in the proposal.

MI = Mill Shipping Index – in dollars (\$) per hundredweight (CWT). Use the adjustment indices from the month the steel was shipped from the producing mill, received on the project, or member cast as defined in the Product Relationship Table.

Q = Quantity of steel product, in pounds (lbs.) actually incorporated into the work as documented by the Contractor, or Design Build Team and verified by the Engineer.

$$\text{BI} = \$29.21 / \text{CWT}$$

$$\text{MI} = \$43.13 / \text{CWT}$$

$$\% \text{ change} = ((\text{MI} / \text{BI}) - 1) = (\$43.13 / \$29.21 - 1) = (1.47655 - 1) = 0.47654912701$$

$$\text{Q} = 103932 \text{ lbs.}$$

$$\text{SPA} = 0.47654912701 * \$29.21 * (103,932 / 100)$$

$$\text{SPA} = 0.47654912701 * \$29.21 * 1,039.32$$

SPA = \$14,467.33 Pay Adjustment to Contractor for Reinforced Concrete Deck Slab (Category 1) at Station 107+45.55 -L-

SCHEDULE OF ESTIMATED COMPLETION PROGRESS:

(7-15-08)(Rev. 7-16-24)

108-2

SP1 G58

The Contractor's attention is directed to the Standard Special Provision entitled *Availability of Funds Termination of Contracts* included elsewhere in this proposal. The Department of Transportation's schedule of estimated completion progress for this project as required by that Standard Special Provision is as follows:

	<u>Fiscal Year</u>	<u>Progress (% of Dollar Value)</u>
2025	(7/01/24 - 6/30/25)	31% of Total Amount Bid
2026	(7/01/25 - 6/30/26)	61% of Total Amount Bid
2027	(7/01/26 - 6/30/27)	8% of Total Amount Bid

The Contractor shall also furnish his own progress schedule in accordance with Article 108-2 of the *Standard Specifications*. Any acceleration of the progress as shown by the Contractor's progress schedule over the progress as shown above shall be subject to the approval of the Engineer.

MINORITY BUSINESS ENTERPRISE AND WOMEN BUSINESS ENTERPRISE:

(10-16-07)(Rev. 5-9-24)

102-15(J)

SP1 G66

Description

The purpose of this Special Provision is to carry out the North Carolina Department of Transportation's policy of ensuring nondiscrimination in the award and administration of contracts financed in whole or in part with State funds.

Definitions

Additional MBE/WBE Subcontractors - Any MBE/WBE submitted at the time of bid that will not be used to meet the Combined MBE /WBE Goal. No submittal of a Letter of Intent is required.

Combined MBE/WBE Goal: A portion of the total contract, expressed as a percentage that is to be performed by committed MBE/WBE subcontractors.

Committed MBE/WBE Subcontractor - Any MBE/WBE submitted at the time of bid that is being used to meet the Combined MBE /WBE goal by submission of a Letter of Intent. Or any MBE or WBE used as a replacement for a previously committed MBE or WBE firm.

Contract Goal Requirement - The approved participation at time of award, but not greater than the advertised Combined MBE/WBE contract goal.

Goal Confirmation Letter - Written documentation from the Department to the bidder confirming the Contractor's approved, committed participation along with a listing of the committed MBE and WBE firms.

Manufacturer - A firm that owns (or leases) and operates or maintains a factory or establishment that produces on the premises, the materials or supplies obtained by the Contractor. A firm that

makes minor modifications to the materials, supplies, articles, or equipment is not a manufacturer.

MBE Participation (Anticipated) - A portion of the total contract, expressed as a percentage that is anticipated to be performed by committed MBE subcontractor(s).

Minority Business Enterprise (MBE) - A firm certified as a Disadvantaged Minority-Owned Business Enterprise through the North Carolina Unified Certification Program.

Regular Dealer - A firm that owns (or leases), and operates a store, warehouse, or other establishment in which the materials or supplies required for the performance of the contract are bought, kept in sufficient quantities, and regularly sold to the public in the usual course of business. A regular dealer engages in, as its principal business and in its own name, the purchase and sale or lease of the products in question. A regular dealer in such bulk items as steel, concrete or concrete products, gravel, stone, asphalt and petroleum products need not keep such products in stock, if it owns and operates distribution equipment for the products. Any supplement of regular dealers' own distribution equipment shall be by a long-term operating lease and not on an ad hoc or contract-by-contract basis.

Distributor - A firm that engages in the regular sale or lease of the items specified by the contract. A distributor assumes responsibility for the items it purchases once they leave the point of origin (e.g., a manufacturer's facility), making it liable for any loss or damage not covered by the carrier's insurance.

Replacement / Substitution - A full or partial reduction in the amount of work subcontracted to a committed (or an approved substitute) MBE/WBE firm.

North Carolina Unified Certification Program (NCUCP) - A program that provides comprehensive services and information to applicants for MBE/WBE certification. The MBE/WBE program follows the same regulations as the federal Disadvantaged Business Enterprise (DBE) program in accordance with 49 CFR Part 26.

United States Department of Transportation (USDOT) - Federal agency responsible for issuing regulations (49 CFR Part 26) and official guidance for the DBE program.

WBE Participation (Anticipated) - A portion of the total contract, expressed as a percentage, that is anticipated to be performed by committed WBE subcontractor(s).

Women Business Enterprise (WBE) - A firm certified as a Disadvantaged Women-Owned Business Enterprise through the North Carolina Unified Certification Program.

Forms and Websites Referenced in this Provision

Payment Tracking System - On-line system in which the Contractor enters the payments made to MBE and WBE subcontractors who have performed work on the project.
<https://apps.dot.state.nc.us/Vendor/PaymentTracking/>

DBE-IS Subcontractor Payment Information - Form for reporting the payments made to all MBE/WBE firms working on the project. This form is for paper bid projects only.

<https://connect.ncdot.gov/business/Turnpike/Documents/Form%20DBE-IS%20Subcontractor%20Payment%20Information.pdf>

RF-1 MBE/WBE Replacement Request Form - Form for replacing a committed MBE or WBE.

<https://connect.ncdot.gov/projects/construction/Construction%20Forms/DBE%20MBE%20WBE%20Replacement%20Form%20and%20Instructions.pdf>

SAF Subcontract Approval Form - Form required for approval to sublet the contract.

<https://connect.ncdot.gov/projects/construction/Construction%20Forms/SAF%20Form%20-%20Subcontract%20Approval%20Form%20Revised%2004-19.xlsm>

JC-1 Joint Check Notification Form - Form and procedures for joint check notification. The form acts as a written joint check agreement among the parties providing full and prompt disclosure of the expected use of joint checks.

<http://connect.ncdot.gov/projects/construction/Construction%20Forms/Joint%20Check%20Notification%20Form.pdf>

Letter of Intent - Form signed by the Contractor and the MBE/WBE subcontractor, manufacturer or regular dealer that affirms that a portion of said contract is going to be performed by the signed MBE/WBE for the estimated amount (based on quantities and unit prices) listed at the time of bid.

<http://connect.ncdot.gov/letting/LetCentral/Letter%20of%20Intent%20to%20Perform%20as%20a%20Subcontractor.pdf>

Listing of MBE and WBE Subcontractors Form - Form for entering MBE/WBE subcontractors on a project that will meet the Combined MBE/WBE goal. This form is for paper bids only.

[http://connect.ncdot.gov/municipalities/Bid%20Proposals%20for%20LGA%20Content/09%20MBE-WBE%20Subcontractors%20\(State\).docx](http://connect.ncdot.gov/municipalities/Bid%20Proposals%20for%20LGA%20Content/09%20MBE-WBE%20Subcontractors%20(State).docx)

Subcontractor Quote Comparison Sheet - Spreadsheet for showing all subcontractor quotes in the work areas where MBEs and WBEs quoted on the project. This sheet is submitted with good faith effort packages.

<http://connect.ncdot.gov/business/SmallBusiness/Documents/DBE%20Subcontractor%20Quote%20Comparison%20Example.xls>

DBE Regular Dealer/Distributor Affirmation Form – Form is used to make a preliminary counting determination for each DBE listed as a regular dealer or distributor to assess its eligibility for 60 or 40 percent credit, respectively of the cost of materials or supplies based on its demonstrated capacity and intent to perform as a regular dealer or distributor, as defined in section 49 CFR 26.55 under the contract at issue. A Contractor will submit the completed form with the Letter of Intent.

<https://connect.ncdot.gov/projects/construction/Construction%20Forms/DBE%20Regular%20Dealer-Distributor%20Affirmation%20Form%20-%20USDOT%202024.pdf>

Combined MBE/WBE Goal

The Combined MBE/WBE Goal for this project is **6.0 %**

The Combined Goal was established utilizing the following anticipated participation for Minority Business Enterprises and Women Business Enterprises:

(A) Minority Business Enterprises **3.0 %**

- (1) *If the anticipated MBE participation is more than zero*, the Contractor shall exercise all necessary and reasonable steps to ensure that MBEs participate in at least the percent of the contract as set forth above.
- (2) *If the anticipated MBE participation is zero*, the Contractor shall make an effort to recruit and use MBEs during the performance of the contract. Any MBE participation obtained shall be reported to the Department.

(B) Women Business Enterprises **3.0 %**

- (1) *If the anticipated WBE participation is more than zero*, the Contractor shall exercise all necessary and reasonable steps to ensure that WBEs participate in at least the percent of the contract as set forth above.
- (2) *If the anticipated WBE participation is zero*, the Contractor shall make an effort to recruit and use WBEs during the performance of the contract. Any WBE participation obtained shall be reported to the Department.

The Bidder is required to submit only participation to meet the Combined MBE/WBE Goal. The Combined Goal may be met by submitting all MBE participation, all WBE participation, or a combination of MBE and WBE participation.

Directory of Transportation Firms (Directory)

Real-time information is available about firms doing business with the Department and firms that are certified through NCUCP in the Directory of Transportation Firms. Only firms identified in the Directory as MBE and WBE certified shall be used to meet the Combined MBE/WBE Goal. The Directory can be found at the following link.

<https://www.ebs.nc.gov/VendorDirectory/default.html>

The listing of an individual firm in the directory shall not be construed as an endorsement of the firm's capability to perform certain work.

Listing of MBE/WBE Subcontractors

At the time of bid, bidders shall submit all MBE and WBE participation that they anticipate to use during the life of the contract. Only those identified to meet the Combined MBE/WBE Goal will be considered committed, even though the listing shall include both committed MBE/WBE subcontractors and additional MBE/WBE subcontractors. Any additional MBE/WBE subcontractor participation above the goal will follow the banking guidelines found elsewhere in this provision. All other additional MBE/WBE subcontractor participation submitted at the time of bid will be used toward the Department's overall race-neutral goals. Only those firms with current MBE and WBE certification at the time of bid opening will be acceptable for listing in the bidder's submittal of MBE and WBE participation. The Contractor shall indicate the following required information:

(A) Electronic Bids

Bidders shall submit a listing of MBE and WBE participation in the appropriate section of the electronic submittal file.

- (1) Submit the names and addresses of MBE and WBE firms identified to participate in the contract. If the bidder uses the updated listing of MBE and WBE firms shown in the electronic submittal file, the bidder may use the dropdown menu to access the name and address of the firms.
- (2) Submit the contract line numbers of work to be performed by each MBE and WBE firm. When no figures or firms are entered, the bidder will be considered to have no MBE or WBE participation.
- (3) The bidder shall be responsible for ensuring that the MBE and WBE are certified at the time of bid by checking the Directory of Transportation Firms. If the firm is not certified at the time of the bid-letting, that MBE's or WBE's participation will not count towards achieving the Combined MBE/WBE goal.

(B) Paper Bids

- (1) *If the Combined MBE/WBE Goal is more than zero,*
 - (a) Bidders, at the time the bid proposal is submitted, shall submit a listing of MBE/WBE participation, including the names and addresses on *Listing of MBE and WBE Subcontractors* contained elsewhere in the contract documents in order for the bid to be considered responsive. Bidders shall indicate the total dollar value of the MBE and WBE participation for the contract.
 - (b) If bidders have no MBE or WBE participation, they shall indicate this on the *Listing of MBE and WBE Subcontractors* by entering the word "None" or the number "0." This form shall be completed in its entirety. **Blank forms will not be deemed to represent zero participation.** Bids submitted that do not have MBE and WBE participation indicated on the

appropriate form will not be read publicly during the opening of bids. The Department will not consider these bids for award and the proposal will be rejected.

- (c) The bidder shall be responsible for ensuring that the MBE/WBE is certified at the time of bid by checking the Directory of Transportation Firms. If the firm is not certified at the time of the bid-letting, that MBE's or WBE's participation will not count towards achieving the Combined MBE/WBE Goal.
- (2) *If the Combined MBE/WBE Goal is zero, entries on the Listing of MBE and WBE Subcontractors are not required for the zero goal, however any MBE or WBE participation that is achieved during the project shall be reported in accordance with requirements contained elsewhere in the special provision.*

MBE or WBE Prime Contractor

When a certified MBE or WBE firm bids on a contract that contains a Combined MBE/WBE goal, the firm is responsible for meeting the goal or making good faith efforts to meet the goal, just like any other bidder. In most cases, a MBE or WBE bidder on a contract will meet the Combined MBE/WBE Goal by virtue of the work it performs on the contract with its own forces. However, all the work that is performed by the MBE or WBE bidder and any other similarly certified subcontractors will count toward the goal. The MBE or WBE bidder shall list itself along with any MBE or WBE subcontractors, if any, in order to receive credit toward the goal.

MBE/WBE prime contractors shall also follow Sections A and B listed under *Listing of MBE/WBE Subcontractor* just as a non-MBE/WBE bidder would.

Written Documentation – Letter of Intent

The bidder shall submit written documentation for each MBE/WBE that will be used to meet the Combined MBE/WBE Goal of the contract, indicating the bidder's commitment to use the MBE/WBE in the contract. This documentation shall be submitted on the Department's form titled *Letter of Intent*.

The documentation shall be received in the office of the State Contractor Utilization Engineer or at DBE@ncdot.gov no later than 10:00 a.m. of the sixth calendar day following opening of bids, unless the sixth day falls on an official state holiday. In that situation, it is due in the office of the State Contractor Utilization Engineer no later than 10:00 a.m. on the next official state business day.

If the bidder fails to submit the Letter of Intent from each committed MBE and WBE to be used toward the Combined MBE/WBE Goal, or if the form is incomplete (i.e. both signatures are not present), the MBE/WBE participation will not count toward meeting the Combined MBE/WBE Goal. If the lack of this participation drops the commitment below the Combined MBE/WBE Goal, the Contractor shall submit evidence of good faith efforts for the goal, completed in its entirety, to the State Contractor Utilization Engineer or DBE@ncdot.gov no later than 10:00 a.m. on the eighth calendar day following opening of bids, unless the eighth day falls on an official

state holiday. In that situation, it is due in the office of the State Contractor Utilization Engineer no later than 10:00 a.m. on the next official state business day.

Banking MBE/WBE Credit

If the bid of the lowest responsive bidder exceeds \$500,000 and if the committed MBE/WBE participation submitted exceeds the algebraic sum of the Combined MBE /WBE Goal by \$1,000 or more, the excess will be placed on deposit by the Department for future use by the bidder. Separate accounts will be maintained for MBE and WBE participation and these may accumulate for a period not to exceed 24 months.

When the apparent lowest responsive bidder fails to submit sufficient participation by MBE and WBE firms to meet the advertised goal, as part of the good faith effort, the Department will consider allowing the bidder to withdraw funds to meet the Combined MBE/WBE Goal as long as there are adequate funds available from the bidder's MBE and WBE bank accounts.

Submission of Good Faith Effort

If the bidder fails to meet or exceed the Combined MBE/WBE Goal, the apparent lowest responsive bidder shall submit to the Department documentation of adequate good faith efforts made to reach that specific goal.

A hard copy and an electronic copy of this information shall be received in the office of the State Contractor Utilization Engineer or at DBE@ncdot.gov no later than 10:00 a.m. on the sixth calendar day following opening of bids unless the sixth day falls on an official state holiday. In that situation, it would be due in the office of the State Contractor Utilization Engineer no later than 10:00 a.m. on the next official state business day. If the Contractor cannot send the information electronically, then one complete set and 5 copies of this information shall be received under the same time constraints above.

Note: Where the information submitted includes repetitious solicitation letters, it will be acceptable to submit a representative letter along with a distribution list of the firms that were solicited. Documentation of MBE/WBE quotations shall be a part of the good faith effort submittal. This documentation may include written subcontractor quotations, telephone log notations of verbal quotations, or other types of quotation documentation.

Consideration of Good Faith Effort for Projects with a Combined MBE/WBE Goal More Than Zero

Adequate good faith efforts mean that the bidder took all necessary and reasonable steps to achieve the goal which, by their scope, intensity, and appropriateness, could reasonably be expected to obtain sufficient MBE/WBE participation. Adequate good faith efforts also mean that the bidder actively and aggressively sought MBE/WBE participation. Mere *pro forma* efforts are not considered good faith efforts.

The Department will consider the quality, quantity, and intensity of the different kinds of efforts a bidder has made. Listed below are examples of the types of actions a bidder will take in making a good faith effort to meet the goals and are not intended to be exclusive or exhaustive, nor is it intended to be a mandatory checklist.

- (A) Soliciting through all reasonable and available means (e.g. attendance at pre-bid meetings, advertising, written notices, use of verifiable electronic means through the use of the NCDOT Directory of Transportation Firms) the interest of all certified MBEs/WBEs that are also prequalified subcontractors. The bidder must solicit this interest within at least 10 days prior to bid opening to allow the MBEs/WBEs to respond to the solicitation. Solicitation shall provide the opportunity to MBEs/WBEs within the Division and surrounding Divisions where the project is located. The bidder must determine with certainty if the MBEs/WBEs are interested by taking appropriate steps to follow up initial solicitations.
- (B) Selecting portions of the work to be performed by MBEs/WBEs in order to increase the likelihood that the Combined MBE/WBE Goal will be achieved.
 - (1) Where appropriate, break out contract work items into economically feasible units to facilitate MBE/WBE participation, even when the prime contractor might otherwise prefer to perform these work items with its own forces.
 - (2) Negotiate with subcontractors to assume part of the responsibility to meet the advertised goal when the work to be sublet includes potential for MBE/WBE participation (2nd and 3rd tier subcontractors).
- (C) Providing interested certified MBEs/WBEs that are also prequalified subcontractors with adequate information about the plans, specifications, and requirements of the contract in a timely manner to assist them in responding to a solicitation.
- (D)
 - (1) Negotiating in good faith with interested MBEs/WBEs. It is the bidder's responsibility to make a portion of the work available to MBE/WBE subcontractors and suppliers and to select those portions of the work or material needs consistent with the available MBE/WBE subcontractors and suppliers, so as to facilitate MBE/WBE participation. Evidence of such negotiation includes the names, addresses, and telephone numbers of MBEs/WBEs that were considered; a description of the information provided regarding the plans and specifications for the work selected for subcontracting; and evidence as to why additional agreements could not be reached for MBEs/WBEs to perform the work.
 - (2) A bidder using good business judgment would consider a number of factors in negotiating with subcontractors, including MBE/WBE subcontractors, and would take a firm's price and capabilities as well as the advertised goal into consideration. However, the fact that there may be some additional costs involved in finding and using MBEs/WBEs is not in itself sufficient reason for a bidder's failure to meet the contract goal, as long as such costs are reasonable. Also, the ability or desire of a prime contractor to perform the work of a contract with its own organization does not relieve the bidder of the responsibility to make

good faith efforts. Bidding contractors are not, however, required to accept higher quotes from MBEs/WBEs if the price difference is excessive or unreasonable.

- (E) Not rejecting MBEs/WBEs as being unqualified without sound reasons based on a thorough investigation of their capabilities. The bidder's standing within its industry, membership in specific groups, organizations, or associates and political or social affiliations (for example, union vs. non-union employee status) are not legitimate causes for the rejection or non-solicitation of bids in the bidder's efforts to meet the project goal.
- (F) Making efforts to assist interested MBEs/WBEs in obtaining bonding, lines of credit, or insurance as required by the recipient or bidder.
- (G) Making efforts to assist interested MBEs/WBEs in obtaining necessary equipment, supplies, materials, or related assistance or services.
- (H) Effectively using the services of available minority/women community organizations; minority/women contractors' groups; Federal, State, and local minority/women business assistance offices; and other organizations as allowed on a case-by-case basis to provide assistance in the recruitment and placement of MBEs/WBEs. Contact within 7 days from the bid opening the Business Opportunity and Work Force Development Unit at BOWD@ncdot.gov to give notification of the bidder's inability to get MBE or WBE quotes.
- (I) Any other evidence that the bidder submits which shows that the bidder has made reasonable good faith efforts to meet the advertised goal.

In addition, the Department may take into account the following:

- (1) Whether the bidder's documentation reflects a clear and realistic plan for achieving the Combined MBE/WBE Goal.
- (2) The bidders' past performance in meeting the contract goal.
- (3) The performance of other bidders in meeting the advertised goal. For example, when the apparent successful bidder fails to meet the goal, but others meet it, you may reasonably raise the question of whether, with additional reasonable efforts the apparent successful bidder could have met the goal. If the apparent successful bidder fails to meet the advertised goal, but meets or exceeds the average MBE and WBE participation obtained by other bidders, the Department may view this, in conjunction with other factors, as evidence of the apparent successful bidder having made a good faith effort.

If the Department does not award the contract to the apparent lowest responsive bidder, the Department reserves the right to award the contract to the next lowest responsive bidder that can satisfy to the Department that the Combined MBE/WBE Goal can be met or that an adequate good faith effort has been made to meet the advertised goal.

Non-Good Faith Appeal

The State Prequalification Engineer will notify the Contractor verbally and in writing of non-good faith. A Contractor may appeal a determination of non-good faith made by the Goal Compliance Committee. If a Contractor wishes to appeal the determination made by the Committee, they shall provide written notification to the State Prequalification Engineer. The appeal shall be made within 2 business days of notification of the determination of non-good faith.

Counting MBE/WBE Participation Toward Meeting the Combined MBE/WBE Goal

(A) Participation

The total dollar value of the participation by a committed MBE/WBE will be counted toward the contract goal requirements. The total dollar value of participation by a committed MBE/WBE will be based upon the value of work performed by the MBE/WBE and the actual payments to MBE/WBE firms by the Contractor.

(B) Joint Checks

Prior notification of joint check use shall be required when counting MBE/WBE participation for services or purchases that involves the use of a joint check. Notification shall be through submission of Form JC-1 (*Joint Check Notification Form*) and the use of joint checks shall be in accordance with the Department's Joint Check Procedures.

(C) Subcontracts (Non-Trucking)

A MBE/WBE may enter into subcontracts. Work that a MBE subcontracts to another MBE firm may be counted toward the anticipated MBE participation. The same holds true for work that a WBE subcontracts to another WBE firm. Work that a MBE/WBE subcontracts to a non-MBE/WBE firm does not count toward the contract goal requirement. It should be noted that every effort shall be made by MBE and WBE contractors to subcontract to the same certification (i.e., MBEs to MBEs and WBEs to WBEs), in order to fulfill the MBE or WBE participation breakdown. This, however, may not always be possible due to the limitation of firms in the area. If the MBE or WBE firm shows a good faith effort has been made to reach out to similarly certified firms and there is no interest or availability, and they can get assistance from other certified firms, the Engineer will not hold the prime responsible for meeting the individual MBE or WBE breakdown. If a MBE or WBE contractor or subcontractor subcontracts a significantly greater portion of the work of the contract than would be expected on the basis of standard industry practices, it shall be presumed that the MBE or WBE is not performing a commercially useful function.

(D) Joint Venture

When a MBE or WBE performs as a participant in a joint venture, the Contractor may count toward its contract goal requirement a portion of the total value of participation

with the MBE or WBE in the joint venture, that portion of the total dollar value being a distinct clearly defined portion of work that the MBE or WBE performs with its forces.

(F) Manufacturer, Regular Dealer, Distributor

A Contractor may count toward its MBE/WBE requirement 40 percent of its expenditures for materials or supplies (including transportation costs) from a MBE/WBE distributor, 60 percent of its expenditures for materials or supplies (including transportation costs) from a MBE/WBE regular dealer and 100 percent of such expenditures obtained from a MBE/WBE manufacturer.

A Contractor may count toward its MBE/WBE requirement the following expenditures to MBE/WBE firms that are not manufacturers, regular dealers or distributors:

- (1) The fees or commissions charged by a MBE/WBE firm for providing a *bona fide* service, such as professional, technical, consultant, or managerial services, or for providing bonds or insurance specifically required for the performance of a DOT-assisted contract, provided the fees or commissions are determined to be reasonable and not excessive as compared with fees and commissions customarily allowed for similar services.
- (2) With respect to materials or supplies purchased from a MBE/WBE, which is neither a manufacturer, regular dealer, nor a distributor count the entire amount of fees or commissions charged that the Department deems to be reasonable, including transportation charges for the delivery of materials or supplies. Do not count any portion of the cost of the materials and supplies themselves.

A Contractor will submit a completed *DBE Regular Dealer/Distributor Affirmation Form* with the Letter of Intent to the State Contractor Utilization Engineer or DBE@ncdot.gov. The State Contractor Utilization Engineer will make a preliminary assessment as to whether a MBE/WBE supplier has the demonstrated capacity to perform a commercially useful function (CUF) on a contract-by-contract basis *prior* to its participation.

Commercially Useful Function**(A) MBE/WBE Utilization**

The Contractor may count toward its contract goal requirement only expenditures to MBEs and WBEs that perform a commercially useful function in the work of a contract. A MBE/WBE performs a commercially useful function when it is responsible for execution of the work of the contract and is carrying out its responsibilities by performing, managing, and supervising the work involved. To perform a commercially useful function, the MBE/WBE shall also be responsible with respect to materials and supplies used on the contract, for negotiating price, determining quality and quantity, ordering the material and installing (where applicable) and paying for the material itself. To determine whether a MBE/WBE is performing a commercially useful function, the Department will evaluate the amount of work subcontracted, industry practices, whether the amount the firm is to be paid under the contract is commensurate with the work it is performing and the MBE/WBE credit claimed for its performance of the work, and any other relevant factors. If it is determined that a MBE or WBE is not performing a Commercially Useful Function, the contractor may present evidence to rebut this presumption to the Department.

(B) MBE/WBE Utilization in Trucking

The following factors will be used to determine if a MBE or WBE trucking firm is performing a commercially useful function:

- (1) The MBE/WBE shall be responsible for the management and supervision of the entire trucking operation for which it is responsible on a particular contract, and there shall not be a contrived arrangement for the purpose of meeting the Combined MBE/WBE Goal.
- (2) The MBE/WBE shall itself own and operate at least one fully licensed, insured, and operational truck used on the contract.
- (3) The MBE/WBE receives credit for the total value of the transportation services it provides on the contract using trucks it owns, insures, and operates using drivers it employs.
- (4) The MBE may subcontract the work to another MBE firm, including an owner-operator who is certified as a MBE. The same holds true that a WBE may subcontract the work to another WBE firm, including an owner-operator who is certified as a WBE. When this occurs, the MBE or WBE who subcontracts work receives credit for the total value of the transportation services the subcontracted MBE or WBE provides on the contract. It should be noted that every effort shall be made by MBE and WBE contractors to subcontract to the same certification (i.e., MBEs to MBEs and WBEs to WBEs), in order to fulfill the participation breakdown. This, however, may not always be possible due to the limitation of firms in the area. If the MBE or WBE firm shows a good faith

effort has been made to reach out to similarly certified transportation service providers and there is no interest or availability, and they can get assistance from other certified providers, the Engineer will not hold the prime responsible for meeting the individual MBE or WBE participation breakdown.

- (5) The MBE/WBE may also subcontract the work to a non-MBE/WBE firm, including from an owner-operator. The MBE/WBE who subcontracts the work to a non-MBE/WBE is entitled to credit for the total value of transportation services provided by the non-MBE/WBE subcontractor not to exceed the value of transportation services provided by MBE/WBE-owned trucks on the contract. Additional participation by non-MBE/WBE subcontractors receives credit only for the fee or commission it receives as a result of the subcontract arrangement. The value of services performed under subcontract agreements between the MBE/WBE and the Contractor will not count towards the MBE/WBE contract requirement.
- (6) A MBE/WBE may lease truck(s) from an established equipment leasing business open to the general public. The lease must indicate that the MBE/WBE has exclusive use of and control over the truck. This requirement does not preclude the leased truck from working for others during the term of the lease with the consent of the MBE/WBE, so long as the lease gives the MBE/WBE absolute priority for use of the leased truck. This type of lease may count toward the MBE/WBE's credit as long as the driver is under the MBE/WBE's payroll.
- (7) Subcontracted/leased trucks shall display clearly on the dashboard the name of the MBE/WBE that they are subcontracted/leased to and their own company name if it is not identified on the truck itself. Magnetic door signs are not permitted.

MBE/WBE Replacement

When a Contractor has relied on a commitment to a MBE or WBE subcontractor (or an approved substitute MBE or WBE subcontractor) to meet all or part of a contract goal requirement, the contractor shall not terminate the MBE/WBE subcontractor or any portion of its work for convenience. This includes, but is not limited to, instances in which the Contractor seeks to perform the work of the terminated subcontractor with another MBE/WBE subcontractor, a non-MBE/WBE subcontractor, or with the Contractor's own forces or those of an affiliate.

The Contractor must give notice in writing both by certified mail and email to the MBE/WBE subcontractor, with a copy to the Engineer of its intent to request to terminate a MBE/WBE subcontractor or any portion of its work, and the reason for the request. The Contractor must give the MBE/WBE subcontractor five (5) business days to respond to the Contractor's Notice of Intent to Request Termination and/or Substitution. If the MBE/WBE subcontractor objects to the intended termination/substitution, the MBE/WBE, within five (5) business days must advise the Contractor and the Department of the reasons why the action should not be approved. The five-day notice period shall begin on the next business day after written notice is provided to the MBE/WBE subcontractor.

A committed MBE/WBE subcontractor may only be terminated or any portion of its work after receiving the Department's written approval based upon a finding of good cause for the proposed termination and/or substitution. Good cause does not exist if the Contractor seeks to terminate a MBE/WBE or any portion of its work that it relied upon to obtain the contract so that the Contractor can self-perform the work for which the MBE/WBE was engaged, or so that the Contractor can substitute another MBE/WBE or non- MBE/WBE contractor after contract award. For purposes of this section, good cause shall include the following circumstances:

- (a) The listed MBE/WBE subcontractor fails or refuses to execute a written contract;
- (b) The listed MBE/WBE subcontractor fails or refuses to perform the work of its subcontract in a way consistent with normal industry standards. Provided, however, that good cause does not exist if the failure or refusal of the MBE/WBE subcontractor to perform its work on the subcontract results from the bad faith or discriminatory action of the prime contractor;
- (c) The listed MBE/WBE subcontractor fails or refuses to meet the prime contractor's reasonable, nondiscriminatory bond requirements;
- (d) The listed MBE/WBE subcontractor becomes bankrupt, insolvent, or exhibits credit unworthiness;
- (e) The listed MBE/WBE subcontractor is ineligible to work on public works projects because of suspension and debarment proceedings pursuant to 2 CFR parts 180, 215 and 1200 or applicable State law;
- (f) The listed MBE/WBE subcontractor is not a responsible contractor;
- (g) The listed MBE/WBE voluntarily withdraws from the project and provides written notice of withdrawal;
- (h) The listed MBE/WBE is ineligible to receive MBE/WBE credit for the type of work required;
- (i) A MBE/WBE owner dies or becomes disabled with the result that the listed MBE/WBE contractor is unable to complete its work on the contract; and
- (j) Other documented good cause that compels the termination of the MBE/WBE subcontractor.

The Contractor shall comply with the following for replacement of a committed MBE/WBE:

(A) Performance Related Replacement

When a committed MBE/WBE is terminated for good cause as stated above, an additional MBE/WBE that was submitted at the time of bid may be used to fulfill the MBE/WBE commitment to meet the Combined MBE/WBE Goal. A good faith effort will only be required for removing a committed MBE/WBE if there were no additional MBE/WBEs submitted at the time of bid to cover the same amount of work as the MBE/WBE that was terminated.

If a replacement MBE/WBE is not found that can perform at least the same amount of work as the terminated MBE/WBE, the Contractor shall submit a good faith effort documenting the steps taken. Such documentation shall include, but not be limited to, the following:

- (1) Copies of written notification to MBE/WBEs that their interest is solicited in contracting the work defaulted by the previous MBE/WBE or in subcontracting other items of work in the contract.
 - (2) Efforts to negotiate with MBE/WBEs for specific subbids including, at a minimum:
 - (a) The names, addresses, and telephone numbers of MBE/WBEs who were contacted.
 - (b) A description of the information provided to MBE/WBEs regarding the plans and specifications for portions of the work to be performed.
 - (3) A list of reasons why MBE/WBE quotes were not accepted.
 - (4) Efforts made to assist the MBE/WBEs contacted, if needed, in obtaining bonding or insurance required by the Contractor.
- (B) Decertification Replacement
- (1) When a committed MBE/WBE is decertified by the Department after the SAF (*Subcontract Approval Form*) has been received by the Department, the Department will not require the Contractor to solicit replacement MBE/WBE participation equal to the remaining work to be performed by the decertified firm. The participation equal to the remaining work performed by the decertified firm will count toward the contract goal requirement but not the overall goal.
 - (i) If the MBE/WBE's ineligibility is caused solely by its having exceeded the size standard during the performance of the contract. The Department may continue to count participation equal to the remaining work performed by the decertified firm which will count toward the contract goal requirement and overall goal.
 - (ii) If the MBE/WBE's ineligibility is caused solely by its acquisition by or merger with a non- MBE/WBE during the performance of the contract. The Department may not continue to count the portion of the decertified firm's performance on the contract remaining toward either the contract goal or the overall goal, even if the Contractor has executed a subcontract with the firm or the Department has executed a prime contract with the MBE/WBE that was later decertified.
 - (2) When a committed MBE/WBE is decertified prior to the Department receiving the SAF (*Subcontract Approval Form*) for the named MBE/WBE firm, the

Contractor shall take all necessary and reasonable steps to replace the MBE/WBE subcontractor with another MBE/WBE subcontractor to perform at least the same amount of work to meet the Combined MBE/WBE goal requirement. If a MBE/WBE firm is not found to do the same amount of work, a good faith effort must be submitted to NCDOT (see A herein for required documentation).

All requests for replacement of a committed MBE/WBE firm shall be submitted to the Engineer for approval on Form RF-1 (*DBE Replacement Request*). If the Contractor fails to follow this procedure, the Contractor may be disqualified from further bidding for a period of up to 6 months.

Changes in the Work

When the Engineer makes changes that result in the reduction or elimination of work to be performed by a committed MBE/WBE, the Contractor will not be required to seek additional participation. When the Engineer makes changes that result in additional work to be performed by a MBE/WBE based upon the Contractor's commitment, the MBE/WBE shall participate in additional work to the same extent as the MBE/WBE participated in the original contract work.

When the Engineer makes changes that result in extra work, which has more than a minimal impact on the contract amount, the Contractor shall seek additional participation by MBEs/WBEs unless otherwise approved by the Engineer.

When the Engineer makes changes that result in an alteration of plans or details of construction, and a portion or all of the work had been expected to be performed by a committed MBE/WBE, the Contractor shall seek participation by MBEs/WBEs unless otherwise approved by the Engineer.

When the Contractor requests changes in the work that result in the reduction or elimination of work that the Contractor committed to be performed by a MBE/WBE, the Contractor shall seek additional participation by MBEs/WBEs equal to the reduced MBE/WBE participation caused by the changes.

Reports and Documentation

A SAF (*Subcontract Approval Form*) shall be submitted for all work which is to be performed by a MBE/WBE subcontractor. The Department reserves the right to require copies of actual subcontract agreements involving MBE/WBE subcontractors.

When using transportation services to meet the contract commitment, the Contractor shall submit a proposed trucking plan in addition to the SAF. The plan shall be submitted prior to beginning construction on the project. The plan shall include the names of all trucking firms proposed for use, their certification type(s), the number of trucks owned by the firm, as well as the individual truck identification numbers, and the line item(s) being performed.

Within 30 calendar days of entering into an agreement with a MBE/WBE for materials, supplies or services, not otherwise documented by the SAF as specified above, the Contractor shall

furnish the Engineer a copy of the agreement. The documentation shall also indicate the percentage (60% or 100%) of expenditures claimed for MBE/WBE credit.

Reporting Minority and Women Business Enterprise Participation

The Contractor shall provide the Engineer with an accounting of payments made to all MBE/WBE firms, including material suppliers and contractors at all levels (prime, subcontractor, or second tier subcontractor). This accounting shall be furnished to the Engineer for any given month by the end of the following month. Failure to submit this information accordingly may result in the following action:

- (A) Withholding of money due in the next partial pay estimate; or
- (B) Removal of an approved contractor from the prequalified bidders' list or the removal of other entities from the approved subcontractors list.

While each contractor (prime, subcontractor, 2nd tier subcontractor) is responsible for accurate accounting of payments to MBEs/WBEs, it shall be the prime contractor's responsibility to report all monthly and final payment information in the correct reporting manner.

Failure on the part of the Contractor to submit the required information in the time frame specified may result in the disqualification of that contractor and any affiliate companies from further bidding until the required information is submitted.

Failure on the part of any subcontractor to submit the required information in the time frame specified may result in the disqualification of that contractor and any affiliate companies from being approved for work on future DOT projects until the required information is submitted.

Contractors reporting transportation services provided by non-MBE/WBE lessees shall evaluate the value of services provided during the month of the reporting period only.

At any time, the Engineer can request written verification of subcontractor payments.

The Contractor shall report the accounting of payments through the Department's Payment Tracking System.

Failure to Meet Contract Requirements

Failure to meet contract requirements in accordance with Subarticle 102-15(J) of the *Standard Specifications* may be cause to disqualify the Contractor.

RESTRICTIONS ON ITS EQUIPMENT AND SERVICES:

(11-17-20)

SP1 G090

All telecommunications, video or other ITS equipment or services installed or utilized on this project must be in conformance with UNIFORM ADMINISTRATIVE REQUIREMENTS, COST PRINCIPLES, AND AUDIT REQUIREMENTS FOR FEDERAL AWARDS **2 CFR, § 200.216 Prohibition on certain telecommunications and video surveillance services or equipment.**

USE OF UNMANNED AIRCRAFT SYSTEM (UAS):

(8-20-19)

SP1 G092

The Contractor shall adhere to all Federal, State and Local regulations and guidelines for the use of Unmanned Aircraft Systems (UAS). This includes but is not limited to US 14 CFR Part 107 *Small UAS Rule*, NC GS 15A-300.2 *Regulation of launch and recovery sites*, NC GS 63-95 *Training required for the operation of unmanned aircraft systems*, NC GS 63-96 *Permit required for commercial operation of unmanned aircraft system*, and NCDOT UAS Policy. The required operator certifications include possessing a current Federal Aviation Administration (FAA) Remote Pilot Certificate, a NC UAS Operator Permit as well as operating a UAS registered with the FAA.

Prior to beginning operations, the Contractor shall complete the NCDOT UAS – Flight Operation Approval Form and submit it to the Engineer for approval. All UAS operations shall be approved by the Engineer prior to beginning the operations.

All contractors or subcontractors operating UAS shall have UAS specific general liability insurance to cover all operations under this contract.

The use of UAS is at the Contractor's discretion. No measurement or payment will be made for the use of UAS. In the event that the Department directs the Contractor to utilize UAS, payment will be in accordance with Article 104-7 Extra Work.

EQUIPMENT IDLING GUIDELINES:

(1-19-21)

107

SP1 G096

Exercise reduced fuel consumption and reduced equipment emissions during the construction of all work associated with this contract. Employees engaged in the construction of this project should turn off vehicles when stopped for more than thirty (30) minutes and off-highway equipment should idle no longer than fifteen (15) consecutive minutes.

These guidelines for turning off vehicles and equipment when idling do not apply to:

1. Idling when queuing.
2. Idling to verify the vehicle is in safe operating condition.
3. Idling for testing, servicing, repairing or diagnostic purposes.
4. Idling necessary to accomplish work for which the vehicle was designed (such as operating a crane, mixing concrete, etc.).
5. Idling required to bring the machine system to operating temperature.

6. Emergency vehicles, utility company, construction, and maintenance vehicles where the engines must run to perform needed work.
7. Idling to ensure safe operation of the vehicle.
8. Idling when the propulsion engine is providing auxiliary power for other than heating or air conditioning. (such as hydraulic systems for pavers)
9. When specific traffic, safety, or emergency situations arise.
10. If the ambient temperature is less than 32 degrees Fahrenheit. Limited idling to provide for the safety of vehicle occupants (e.g. to run the heater).
11. If the ambient temperature is greater than 90 degrees Fahrenheit. Limited idling to provide for the safety of vehicle occupants of off-highway equipment (e.g. to run the air conditioning) no more than 30 minutes.
12. Diesel powered vehicles may idle for up to 30 minutes to minimize restart problems.

Any vehicle, truck, or equipment in which the primary source of fuel is natural gas or electricity is exempt from the idling limitations set forth in this special provision.

SUBSURFACE INFORMATION:

(7-1-95)

450

SP1 G112 C

Subsurface information is available on the roadway and structure portions of this project.

MAINTENANCE OF THE PROJECT:

(11-20-07)(Rev. 1-16-24)

104-10

SP1 G125

Revise the *Standard Specifications* as follows:

Page 1-35, Article 104-10 Maintenance of the Project, line 3, add the following after the first sentence of the first paragraph:

All guardrail/guiderail within the project limits shall be included in this maintenance.

Page 1-35, Article 104-10 MAINTENANCE OF THE PROJECT, line 8, add the following as the last sentence of the first paragraph:

The Contractor shall perform weekly inspections of guardrail and guiderail and shall report damages to the Engineer on the same day of the weekly inspection. *Where damaged guardrail or guiderail is repaired or replaced as a result of maintaining the project in accordance with this article, such repair or replacement shall be performed within 7 consecutive calendar days of such inspection report.*

Page 1-35, Article 104-10 MAINTENANCE OF THE PROJECT, lines 20-22, replace the last sentence of the last paragraph with the following:

The Contractor will not be directly compensated for any maintenance operations necessary, except for maintenance of guardrail/guiderail, as this work will be considered incidental to the work covered by the various contract items. The provisions of Article 104-7, Extra Work, and Article 104-8, Compensation and Record Keeping will apply to authorized maintenance of guardrail/guiderail. Performance of weekly inspections of guardrail/guiderail, and the damage

reports required as described above, will be considered to be an incidental part of the work being paid for by the various contract items.

COOPERATION BETWEEN CONTRACTORS:

(7-1-95)(Rev. 1-16-24)

105-7

SP1 G133

The Contractor's attention is directed to Article 105-7 of the *Standard Specifications*.

U-4714AC (Mecklenburg) / U-4714B (Union) is located adjacent to this project. U-4714AC / U-4714B is anticipated for a February 17, 2026 Letting.

The Contractor on this project shall cooperate with the Contractor working within or adjacent to the limits of this project to the extent that the work can be carried out to the best advantage of all concerned.

TWELVE MONTH GUARANTEE:

(7-15-03)

108

SP1 G145

- (A) The Contractor shall guarantee materials and workmanship against latent and patent defects arising from faulty materials, faulty workmanship or negligence for a period of twelve months following the date of final acceptance of the work for maintenance and shall replace such defective materials and workmanship without cost to the Department. The Contractor will not be responsible for damage due to faulty design, normal wear and tear, for negligence on the part of the Department, and/or for use in excess of the design.
- (B) Where items of equipment or material carry a manufacturer's guarantee for any period in excess of twelve months, then the manufacturer's guarantee shall apply for that particular piece of equipment or material. The Department's first remedy shall be through the manufacturer although the Contractor is responsible for invoking the warranted repair work with the manufacturer. The Contractor's responsibility shall be limited to the term of the manufacturer's guarantee. NCDOT would be afforded the same warranty as provided by the Manufacturer.

This guarantee provision shall be invoked only for major components of work in which the Contractor would be wholly responsible for under the terms of the contract. Examples would include pavement structures, bridge components, and sign structures. This provision will not be used as a mechanism to force the Contractor to return to the project to make repairs or perform additional work that the Department would normally compensate the Contractor for. In addition, routine maintenance activities (i.e. mowing grass, debris removal, ruts in earth shoulders,) are not parts of this guarantee.

Appropriate provisions of the payment and/or performance bonds shall cover this guarantee for the project.

To ensure uniform application statewide the Division Engineer will forward details regarding the circumstances surrounding any proposed guarantee repairs to the Chief Engineer for review and approval prior to the work being performed.

OUTSOURCING OUTSIDE THE USA:

(9-21-04) (Rev. 5-16-06)

SP1 G150

All work on consultant contracts, services contracts, and construction contracts shall be performed in the United States of America. No work shall be outsourced outside of the United States of America.

Outsourcing for the purpose of this provision is defined as the practice of subcontracting labor, work, services, staffing, or personnel to entities located outside of the United States.

The North Carolina Secretary of Transportation shall approve exceptions to this provision in writing.

EROSION AND SEDIMENT CONTROL/STORMWATER CERTIFICATION:

(1-16-07) (Rev. 10-15-24)

105-16, 225-2, 16

SP1 G180

General

Schedule and conduct construction activities in a manner that will minimize soil erosion and the resulting sedimentation and turbidity of surface waters. Comply with the requirements herein regardless of whether or not a National Pollution discharge Elimination System (NPDES) permit for the work is required.

Establish a chain of responsibility for operations and subcontractors' operations to ensure that the *Erosion and Sediment Control/Stormwater Pollution Prevention Plan* is implemented and maintained over the life of the contract.

- (A) *Certified Supervisor* - Provide a certified Erosion and Sediment Control/Stormwater Supervisor to manage the Contractor and subcontractor operations, insure compliance with Federal, State and Local ordinances and regulations, and manage the Quality Control Program.
- (B) *Certified Foreman* - Provide a certified, trained foreman for each construction operation that increases the potential for soil erosion or the possible sedimentation and turbidity of surface waters.
- (C) *Certified Installer* - Provide a certified installer to install or direct the installation for erosion or sediment/stormwater control practices.
- (D) *Certified Designer* - Provide a certified designer for the design of the erosion and sediment control/stormwater component of reclamation plans and, if applicable, for the design of the project erosion and sediment control/stormwater plan.

Roles and Responsibilities

- (A) *Certified Erosion and Sediment Control/Stormwater Supervisor* - The Certified Supervisor shall be Level II and responsible for ensuring the erosion and sediment control/stormwater plan is adequately implemented and maintained on the project and for conducting the quality control program. The Certified Supervisor shall be on the project

within 24 hours notice from initial exposure of an erodible surface to the project's final acceptance. Perform the following duties:

- (1) Manage Operations - Coordinate and schedule the work of subcontractors so that erosion and sediment control/stormwater measures are fully executed for each operation and in a timely manner over the duration of the contract.
 - (a) Oversee the work of subcontractors so that appropriate erosion and sediment control/stormwater preventive measures are conformed to at each stage of the work.
 - (b) Prepare the required National Pollutant Discharge Elimination System (NPDES) Inspection Record and submit to the Engineer.
 - (c) Attend all weekly or monthly construction meetings to discuss the findings of the NPDES inspection and other related issues.
 - (d) Implement the erosion and sediment control/stormwater site plans requested.
 - (e) Provide any needed erosion and sediment control/stormwater practices for the Contractor's temporary work not shown on the plans, such as, but not limited to work platforms, temporary construction, pumping operations, plant and storage yards, and cofferdams.
 - (f) Acquire applicable permits and comply with requirements for borrow pits, dewatering, and any temporary work conducted by the Contractor in jurisdictional areas.
 - (g) Conduct all erosion and sediment control/stormwater work in a timely and workmanlike manner.
 - (h) Fully perform and install erosion and sediment control/stormwater work prior to any suspension of the work.
 - (i) Coordinate with Department, Federal, State and Local Regulatory agencies on resolution of erosion and sediment control/stormwater issues due to the Contractor's operations.
 - (j) Ensure that proper cleanup occurs from vehicle tracking on paved surfaces or any location where sediment leaves the Right-of-Way.
 - (k) Have available a set of erosion and sediment control/stormwater plans that are initialed and include the installation date of Best Management Practices. These practices shall include temporary and permanent groundcover and be properly updated to reflect necessary plan and field changes for use and review by Department personnel as well as regulatory agencies.
- (2) Requirements set forth under the NPDES Permit - The Department's NPDES Stormwater permit (NCS000250) outlines certain objectives and management measures pertaining to construction activities. The permit references *NCG010000, General Permit to Discharge Stormwater* under the NPDES, and states that the Department shall incorporate the applicable requirements into its delegated Erosion and Sediment Control Program for construction activities disturbing one or more acres of land. The Department further incorporates these requirements on all contracted bridge and culvert work at jurisdictional waters, regardless of size. Some of the requirements are, but are not limited to:

- (a) Control project site waste to prevent contamination of surface or ground waters of the state, i.e. from equipment operation/maintenance, construction materials, concrete washout, chemicals, litter, fuels, lubricants, coolants, hydraulic fluids, any other petroleum products, and sanitary waste.
 - (b) Inspect erosion and sediment control/stormwater devices and stormwater discharge outfalls at least once every 7 calendar days and within 24 hours after a rainfall event equal to or greater than 1.0 inch that occurs within a 24 hour period. Additional monitoring may be required at the discretion of Division of Water Resources personnel if the receiving stream is 303(d) listed for turbidity and the project has had documented problems managing turbidity.
 - (c) Maintain an onsite rain gauge or use the Department's Multi-Sensor Precipitation Estimate website to maintain a daily record of rainfall amounts and dates.
 - (d) Maintain erosion and sediment control/stormwater inspection records for review by Department and Regulatory personnel upon request.
 - (e) Implement approved reclamation plans on all borrow pits, waste sites and staging areas.
 - (f) Maintain a log of turbidity test results as outlined in the Department's Procedure for Monitoring Borrow Pit Discharge.
 - (g) Provide secondary containment for bulk storage of liquid materials.
 - (h) Provide training for employees concerning general erosion and sediment control/stormwater awareness, the Department's NPDES Stormwater Permit NCS000250 requirements, and the applicable requirements of the *General Permit, NCG010000*.
 - (i) Report violations of the NPDES permit to the Engineer immediately who will notify the Division of Water Quality Regional Office within 24 hours of becoming aware of the violation.
- (3) Quality Control Program - Maintain a quality control program to control erosion, prevent sedimentation and follow provisions/conditions of permits. The quality control program shall:
- (a) Follow permit requirements related to the Contractor and subcontractors' construction activities.
 - (b) Ensure that all operators and subcontractors on site have the proper erosion and sediment control/stormwater certification.
 - (c) Notify the Engineer when the required certified erosion and sediment control/stormwater personnel are not available on the job site when needed.
 - (d) Conduct the inspections required by the NPDES permit.
 - (e) Take corrective actions in the proper timeframe as required by the NPDES permit for problem areas identified during the NPDES inspections.
 - (f) Incorporate erosion control into the work in a timely manner and stabilize disturbed areas with mulch/seed or vegetative cover on a section-by-section basis.

- (g) Use flocculants approved by state regulatory authorities where appropriate and where required for turbidity and sedimentation reduction.
 - (h) Ensure proper installation and maintenance of temporary erosion and sediment control devices.
 - (i) Remove temporary erosion or sediment control devices when they are no longer necessary as agreed upon by the Engineer.
 - (j) The Contractor's quality control and inspection procedures shall be subject to review by the Engineer. Maintain NPDES inspection records and make records available at all times for verification by the Engineer.
- (B) *Certified Foreman* - At least one Certified Foreman shall be onsite for each type of work listed herein during the respective construction activities to control erosion, prevent sedimentation and follow permit provisions:
- (1) Foreman in charge of grading activities
 - (2) Foreman in charge of bridge or culvert construction over jurisdictional areas
 - (3) Foreman in charge of utility activities

The Contractor may request to use the same person as the Level II Supervisor and Level II Foreman. This person shall be onsite whenever construction activities as described above are taking place. This request shall be approved by the Engineer prior to work beginning.

The Contractor may request to name a single Level II Foreman to oversee multiple construction activities on small bridge or culvert replacement projects. This request shall be approved by the Engineer prior to work beginning.

- (C) *Certified Installers* - Provide at least one onsite, Level I Certified Installer for each of the following erosion and sediment control/stormwater crew:
- (1) Seeding and Mulching
 - (2) Temporary Seeding
 - (3) Temporary Mulching
 - (4) Sodding
 - (5) Silt fence or other perimeter erosion/sediment control device installations
 - (6) Erosion control blanket installation
 - (7) Hydraulic tackifier installation
 - (8) Turbidity curtain installation
 - (9) Rock ditch check/sediment dam installation
 - (10) Ditch liner/matting installation
 - (11) Inlet protection
 - (12) Riprap placement
 - (13) Stormwater BMP installations (such as but not limited to level spreaders, retention/detention devices)
 - (14) Pipe installations within jurisdictional areas

If a Level I *Certified Installer* is not onsite, the Contractor may substitute a Level II Foreman for a Level I Installer, provided the Level II Foreman is not tasked to another crew requiring Level II Foreman oversight.

- (D) *Certified Designer* - Include the certification number of the Level III Certified Designer on the erosion and sediment control/stormwater component of all reclamation plans and if applicable, the certification number of the Level III Certified Designer on the design of the project erosion and sediment control/stormwater plan.

Preconstruction Meeting

Furnish the names of the *Certified Erosion and Sediment Control/Stormwater Supervisor*, *Certified Foremen*, *Certified Installers* and *Certified Designer* and notify the Engineer of changes in certified personnel over the life of the contract within 2 days of change.

Ethical Responsibility

Any company performing work for the North Carolina Department of Transportation has the ethical responsibility to fully disclose any reprimand or dismissal of an employee resulting from improper testing or falsification of records.

Revocation or Suspension of Certification

Upon recommendation of the Chief Engineer to the certification entity, certification for *Supervisor*, *Certified Foremen*, *Certified Installers* and *Certified Designer* may be revoked or suspended with the issuance of an *Immediate Corrective Action (ICA)*, *Notice of Violation (NOV)*, or *Cease and Desist Order* for erosion and sediment control/stormwater related issues.

The Chief Engineer may recommend suspension or permanent revocation of certification due to the following:

- (A) Failure to adequately perform the duties as defined within this certification provision.
- (B) Issuance of an ICA, NOV, or Cease and Desist Order.
- (C) Failure to fully perform environmental commitments as detailed within the permit conditions and specifications.
- (D) Demonstration of erroneous documentation or reporting techniques.
- (E) Cheating or copying another candidate's work on an examination.
- (F) Intentional falsification of records.
- (G) Directing a subordinate under direct or indirect supervision to perform any of the above actions.
- (H) Dismissal from a company for any of the above reasons.
- (I) Suspension or revocation of one's certification by another entity.

Suspension or revocation of a certification will be sent by certified mail to the certificant and the Corporate Head of the company that employs the certificant.

A certificant has the right to appeal any adverse action which results in suspension or permanent revocation of certification by responding, in writing, to the Chief Engineer within 10 calendar days after receiving notice of the proposed adverse action.

Chief Engineer
1536 Mail Service Center
Raleigh, NC 27699-1536

Failure to appeal within 10 calendar days will result in the proposed adverse action becoming effective on the date specified on the certified notice. Failure to appeal within the time specified will result in a waiver of all future appeal rights regarding the adverse action taken. The certificant will not be allowed to perform duties associated with the certification during the appeal process.

The Chief Engineer will hear the appeal and make a decision within 7 days of hearing the appeal. Decision of the Chief Engineer will be final and will be made in writing to the certificant.

If a certification is temporarily suspended, the certificant shall pass any applicable written examination and any proficiency examination, at the conclusion of the specified suspension period, prior to having the certification reinstated.

Measurement and Payment

All work described within this provision and the role of Certified Erosion and Sediment Control/Stormwater Supervisor, Certified Foremen, Certified Installers and Certified Designer will be incidental to the project for which no direct compensation will be made.

PROCEDURE FOR MONITORING BORROW PIT DISCHARGE:

(2-20-07) (Rev. 1-16-24)

105-16, 230, 801

SP1 G181

Water discharge from borrow pit sites shall not cause surface waters to exceed 50 NTUs (nephelometric turbidity unit) in streams not designated as trout waters and 10 NTUs in streams, lakes or reservoirs designated as trout waters. For lakes and reservoirs not designated as trout waters, the turbidity shall not exceed 25 NTUs. If the turbidity exceeds these levels due to natural background conditions, the existing turbidity level shall not be increased.

If during any operating day, the downstream water quality exceeds the standard, the Contractor shall do all of the following:

- (A) Either cease discharge or modify the discharge volume or turbidity levels to bring the downstream turbidity levels into compliance, or
- (B) Evaluate the upstream conditions to determine if the exceedance of the standard is due to natural background conditions. If the background turbidity measurements exceed the standard, operation of the pit and discharge can continue as long as the stream turbidity levels are not increased due to the discharge.

- (C) Measure and record the turbidity test results (time, date and sampler) at all defined sampling locations 30 minutes after startup and at a minimum, one additional sampling of all sampling locations during that 24-hour period in which the borrow pit is discharging.
- (D) Notify DWQ within 24 hours of any stream turbidity standard exceedances that are not brought into compliance.

During the Environmental Assessment required by Article 230-4 of the *Standard Specifications*, the Contractor shall define the point at which the discharge enters into the State's surface waters and the appropriate sampling locations. Sampling locations shall include points upstream and downstream from the point at which the discharge enters these waters. Upstream sampling location shall be located so that it is not influenced by backwater conditions and represents natural background conditions. Downstream sampling location shall be located at the point where complete mixing of the discharge and receiving water has occurred.

The discharge shall be closely monitored when water from the dewatering activities is introduced into jurisdictional wetlands. Any time visible sedimentation (deposition of sediment) on the wetland surface is observed, the dewatering activity will be suspended until turbidity levels in the stilling basin can be reduced to a level where sediment deposition does not occur. Staining of wetland surfaces from suspended clay particles, occurring after evaporation or infiltration, does not constitute sedimentation. No activities shall occur in wetlands that adversely affect the functioning of a wetland. Visible sedimentation will be considered an indication of possible adverse impacts on wetland use.

The Engineer will perform independent turbidity tests on a random basis. These results will be maintained in a log within the project records. Records will include, at a minimum, turbidity test results, time, date and name of sampler. Should the Department's test results exceed those of the Contractor's test results, an immediate test shall be performed jointly with the results superseding the previous test results of both the Department and the Contractor.

The Contractor shall use the *NCDOT Turbidity Reduction Options for Borrow Pits Matrix*, available at <https://connect.ncdot.gov/resources/roadside/FieldOperationsDocuments/TurbidityReductionOptionSheet.pdf> to plan, design, construct, and maintain BMPs to address water quality standards. Tier I Methods include stilling basins which are standard compensatory BMPs. Other Tier I methods are noncompensatory and shall be used when needed to meet the stream turbidity standards. Tier II Methods are also noncompensatory and are options that may be needed for protection of rare or unique resources or where special environmental conditions exist at the site which have led to additional requirements being placed in the DWQ's 401 Certifications and approval letters, Isolated Wetland Permits, Riparian Buffer Authorization or a DOT Reclamation Plan's Environmental Assessment for the specific site. Should the Contractor exhaust all Tier I Methods on a site exclusive of rare or unique resources or special environmental conditions, Tier II Methods may be required by regulators on a case by case basis per supplemental agreement.

The Contractor may use cation exchange capacity (CEC) values from proposed site borings to plan and develop the bid for the project. CEC values exceeding 15 milliequivalents per 100 grams of soil may indicate a high potential for turbidity and should be avoided when dewatering into surface water is proposed.

No additional compensation for monitoring borrow pit discharge will be paid.

NOTES TO CONTRACTOR:

Tree Clearing shall be minimized to the maximum extent possible and limits will be clearly marked for the contractor.

No additional permanent lighting shall be added to the roadway.

Temporary lighting needed for night work shall be downcast and shall be used in areas where trees have already been cleared.

Percussive activities such as guardrail installation shall occur after tree clearing within the action area has occurred.

No blasting shall occur.

PROJECT SPECIAL PROVISIONS**ROADWAY****CLEARING AND GRUBBING - METHOD II:**

(9-17-02)(Rev. 3-19-24)

200

SP2 R02A

Perform clearing on this project to the limits established by Method - II shown on Standard Drawing No. 200.02 of the *Roadway Standard Drawings*. Conventional clearing methods may be used except where permit drawings or conditions have been included in the proposal which require certain areas to be cleared by hand methods.

BURNING RESTRICTIONS:

(7-1-95)

200, 210, 215

SP2 R05

Open burning is not permitted on any portion of the right-of-way limits established for this project. Do not burn the clearing, grubbing or demolition debris designated for disposal and generated from the project at locations within the project limits, off the project limits or at any waste or borrow sites in this county. Dispose of the clearing, grubbing and demolition debris by means other than burning, according to state or local rules and regulations.

LUMP SUM GRADING:

(8-17-10)(Rev. 1-16-24)

226

SP2 R16

Lump sum grading shall be performed in accordance with Section 226 Comprehensive Grading of the *Standard Specifications* except as follows:

Delete all references to **Section 225 Unclassified Excavation (Item 0022)**.

TEMPORARY PAVEMENT:

(7-1-95) (Rev. 11-19-13)

1101

SP2 R30B (Rev)

Construct temporary pavement required on this project in accordance with the plans or as directed by the Engineer.

After the pavement has served its purpose, remove the portions deemed unsuitable for use as a permanent part of the project as directed by the Engineer. Place pavement and earth material removed in embankments or dispose of in waste areas furnished by the Contractor.

Earth material and aggregate base course that is removed will be measured and will be paid at the contract unit price per cubic yard for *Unclassified Excavation*. No direct payment will be made for removing the pavement, as the cost of same shall be included in the lump sum price bid for *Grading*.

Pipe culverts removed from the pavement remain the property of the Contractor. Pipe culverts that are removed will be measured and will be paid at the contract unit price per linear foot for *Pipe Removal*. Payment for the construction of the pavement will be made at the contract unit prices for the various items involved.

Such prices and payments will be full compensation for removing earth material, aggregate base course, and asphalt pavement; removing pipe culverts; and for placing earth material and pavement in embankments or disposing of earth material and pavement in waste areas.

SHOULDER AND FILL SLOPE MATERIAL:

(5-21-02)(Rev. 1-16-24)

235, 560

SP2 R45 A

Description

Perform the required shoulder and slope construction for this project in accordance with the applicable requirements of Section 560 and Section 235 of the *Standard Specifications*.

Measurement and Payment

Where the material has been obtained from an authorized stockpile or from a borrow source and *Borrow Excavation* is not included in the contract, no direct payment will be made for this work, as the cost of this work will be part of the work being paid at the contract lump sum price for *Grading*. If *Borrow Excavation* is included in this contract and the material has been obtained from an authorized stockpile or from a borrow source, measurement and payment will be as provided in Section 230 of the *Standard Specifications* for *Borrow Excavation*.

MANUFACTURED QUARRY FINES IN EMBANKMENTS:

(01-17-17)(Rev. 4-16-24)

235

SP02 R72

Description

This specification addresses the use of manufactured quarry fines that are not classified as select materials. The specification allows the Contractor an option, with the approval of the Engineer, to use manufactured quarry fines (MQFs) in embankments as a substitute for conventional borrow material. Furnish and place geotextile for subgrade stabilization in accordance with the contract. Geotextile for subgrade stabilization is required to prevent pavement cracking and provide separation between the subgrade and pavement section at embankment locations where manufactured quarry fines are utilized and as directed by the Engineer.

Materials

Manufactured Quarry Fines.

Site specific approval of MQFs material will be required prior to beginning construction as detailed in the preconstruction requirements of this provision.

The following MQFs are unacceptable:

- (A) Frozen material,
- (B) Material with a maximum dry unit weight of less than 90 pounds per cubic foot when tested in accordance with AASHTO T 99 Method A or C.
- (C) Material with greater than 80% by weight Passing the #200 sieve

Collect and transport MQFs in a manner that will prevent nuisances and hazards to public health and safety. Moisture condition the MQFs as needed and transport in covered trucks to prevent dusting. If MQFs are blended with natural earth material, follow Borrow Criteria in Section 1018 of the *Standard Specifications*.

Preconstruction Requirements

When MQFs are to be used as a substitute for earth borrow material, request written approval from the Engineer at least ninety (90) days in advance of the intent to use MQFs and include the following details:

- (A) Description, purpose and location of project.
- (B) Estimated start and completion dates of project.
- (C) Estimated volume of MQFs to be used on project with specific locations and construction details of the placement.
- (D) The names, address, and contact information for the generator of the MQFs.
- (E) Physical location of the site at which the MQFs were generated.

The Engineer will forward this information to the State Materials Engineer for review and material approval.

Construction Methods

Place MQFs in the core of the embankment section with at least 4 feet of earth cover to the outside limits of the embankments or subgrade.

Construct embankments by placing MQFs in level uniform lifts with no more than a lift of 10 inches and compacted to at least a density of 95 percent as determined by test methods in AASHTO T 99, Determination of Maximum Dry Density and Optimum Moisture Content, Method A or C depending upon particle size of the product. Provide a moisture content at the time of compaction of within 4 percent of optimum but not greater than one percent above optimum as determined by AASHTO T 99, Method A or C.

In embankments where MQFs are incorporated, geotextile for subgrade stabilization shall be used. Refer to Article 505-2 of the *Standard Specifications* for geotextile type and Article 505-3 of the *Standard Specifications* for the geotextile construction methods.

Measurement and Payment

Borrow Excavation will be measured by truck volume and paid in cubic yards in accordance with Article 230-5 of the *Standard Specifications*. As an alternate weigh tickets can be provided and payment made by converting weight to cubic yards based on the verifiable unit weight. Where the pay item for *Borrow Excavation* is not included in the original contract then no separate payment will be made for this item and payment will be included in the lump sum price bid for *Grading*.

Geotextile for Subgrade Stabilization will be measured and paid in accordance with Article 505-4 of the *Standard Specifications*. When the pay item for *Geotextile for Subgrade Stabilization* is

not included in the original contract then no payment will be made for this item and will be considered incidental to the use of MQFs in embankment.

CORRUGATED ALUMINUM ALLOY CULVERT PIPE:

(9-21-21)(Rev. 1-16-24)

305, 310

SP3 R34

Revise the *Standard Specifications* as follows:

Page 3-5, Article 305-2, MATERIALS, add the following after line 16:

Item	Section
Waterborne Paint	1080-9
Hot Bitumen	1081-3

Page 3-5, Article 305-3, CONSTRUCTION METHODS, add the following after line 26:

Coating must be applied to the aluminum when in contact with concrete. Immediately prior to coating, aluminum surfaces to be coated shall be cleaned by a method that will remove all dirt, oil, grease, chips, and other foreign substances. Aluminum to be coated shall be given one coat of suitable quality coating such as:

Approved waterborne paint (Section 1080-9)

Approved Hot Bitumen (Section 1081-3)

Other coating materials may be submitted to the Engineer for approval.

Page 3-7, Article 310-6, MEASUREMENT AND PAYMENT, lines 10-11, delete the fourth sentence and replace with the following:

Select bedding and backfill material and coating will be included in the cost of the installed pipe.

2" PVC CONDUIT:

Description

Furnish and Install 2" PVC conduit in accordance with Section 1715 of the *Standard Specifications* at locations shown in the plans or as directed by the Resident Engineer. Install two runs of conduit in the same trench with screw-type caps and 90 degree elbows.

Materials

Use Schedule 40 PVC pipe and PVC couplings to join pipe lengths. Use PVC cleaner/primer and PVC cement to achieve water-tight fittings.

Measurement and Payment

2" PVC Conduit will be measured and paid for as the actual number of linear feet of conduit installed and accepted by the Engineer. Measurement will be made along the surface of each conduit. Such price includes all construction and materials which include but is not limited to PVC pipe, elbows, caps, and couplings.

Payment will be made under:

Pay Item	Pay Unit
2" PVC Conduit	Linear Foot

CORRUGATED ALUMINUM ALLOY PIPE ARCH CULVERT:

(9-17-24)

310

SP3 R36

Revise the *Standard Specifications* as follows:

Page 3-7, Article 310-6, MEASUREMENT AND PAYMENT, lines 16, delete “__” C.A.A. Pipe Arch Culvert, __” Thick” and replace with “__” x __” C.A.A. Pipe Arch Culvert, __” Thick”.

Page 3-7, Article 310-6, MEASUREMENT AND PAYMENT, lines 16, delete “__” x __” x __” C.A.A. Pipe Arch Tees, __” Thick” and replace with “__” x __” x __” x __” C.A.A. Pipe Arch Tees, __” Thick”.

Page 3-7, Article 310-6, MEASUREMENT AND PAYMENT, lines 16, delete __” C.A.A. Pipe Arch Elbows, __” Thick” and replace with “__” x __” C.A.A. Pipe Arch Elbows, __” Thick”.

GEOTEXTILE FOR SUBGRADE STABILIZATION:

(5-15-18)(Rev. 4-16-24)

505, 1056

SP5 R9

Description

Provide geotextile for subgrade stabilization in accordance with the contract. Geotextile for subgrade stabilization is required for subgrades to prevent pavement cracking at locations shown in the plans and as directed by the Engineer.

Materials

Refer to Article 505-2 of the *Standard Specifications*.

Construction Methods

Refer to Article 505-3 of the *Standard Specifications*.

Measurement and Payment

Geotextile for Subgrade Stabilization will be measured and paid in accordance with Article 505-4 of the *Standard Specifications*.

PRICE ADJUSTMENT - ASPHALT BINDER FOR PLANT MIX:

(11-21-00)(Rev. 1-16-24)

620

SP6 R25

Price adjustments for asphalt binder for plant mix will be made in accordance with Section 620 of the *Standard Specifications*.

The base price index for asphalt binder for plant mix is **\$ 591.63** per ton.

This base price index represents an average of F.O.B. selling prices of asphalt binder at supplier's terminals on **September 1, 2024**.

FINAL SURFACE TESTING NOT REQUIRED:

(5-18-04) (Rev. 2-16-16)

610

SP6 R45

Final surface testing is not required on this project in accordance with Section 610-13, *Final Surface Testing and Acceptance*.

4" CONCRETE SHARED USE PATH**Description**

The Contractor shall construct a Shared-Use or Multi-Use Path as shown in the plans, in accordance with the applicable requirements of Section 848 of the *Standard Specifications*, and as directed by the Engineer.

Materials

Concrete shall be Class AA Concrete meeting the requirements of Section 1000 of the *Standard Specifications*.

Wire mesh reinforcement shall be either 4x4-W3.5xW3.5 or 6x6-W5xW5 welded wire fabric meeting the requirements of Section 1070 of the *Standard Specifications*. Macro-fibers for concrete reinforcement may be used in lieu of wire mesh reinforcement. See NCDOT Approved Products List for list of macro-fibers.

Construction Methods

Construct concrete path in accordance with Section 848 of the *Standard Specifications*.

Measurement and Payment

4" Concrete Shared Use Path will be measured and paid for in square yards measured along the surface of the completed and accepted work. Such price and payment will include all materials, tools, labor, equipment and incidentals necessary to satisfactorily complete the work.

Payment will be made under:

Pay Item	Pay Unit
4" Concrete Shared Use Path	SY

WOOD RUB RAIL:

Description

Construct wood rub rail at areas indicated in the plans and as directed by the Engineer

Construction

Construct Wood Rub Rail in accordance with the details in the plans.

Measurement and Payment

Wood Rub Rail will be measured and paid in linear feet of wood rub rail that has been satisfactorily completed and accepted by the Engineer. Measurement will be made from center to center of the outermost post in the length of wood rub rail being measured..

Payment will be made under:

Pay Item	Pay Unit
Wood Rub Rail	Linear Foot

TEMPORARY IMPACT ATTENUATOR UNITS, TYPE TL- :

(4-20-04)(Rev. 8-20-24)

SP8 R75REV

Description

Furnish, install and remove the impact attenuator units and any components necessary to connect the impact attenuator units in accordance with the manufacturer's requirement, the details in the plans and at locations shown in the plans.

Materials

Furnish attenuator units listed on the NCDOT APL. Units shall not be modified by the manufacturer and installer once approved and on the NCDOT APL.

Prior to installation the Contractor shall submit to the Engineer certified working drawings and assembling instructions from the manufacturer for each impact attenuator unit in accordance with Article 105-2 of the *Standard Specifications*.

Construction Methods

Perform installation in accordance with the plans and details and assembling instructions furnished by the manufacturer.

Measurement and Payment

Temporary Impact Attenuator Units, Type TL-___ will be measured and paid at the contract unit price per each. Such prices and payment will be full compensation for all work covered by this provision including, but not limited to, furnishing, installing, removing and all incidentals necessary to complete the work.

Payment will be made under:

Pay Item	Pay Unit
Temporary Impact Attenuator Units, Type TL-___	Each

PEDESTRIAN SAFETY RAIL:

(8-28-09)(Rev. 7-18-23)

SPI 8-51

Furnish and install steel pipe handrail at locations as shown in the plans, in accordance with the detail in the plans and as directed by the Engineer.

Measurement and Payment

Pedestrian Safety Rail will be measured and paid as the actual number of linear feet of steel pipe handrail measured along the top of the handrail to the nearest 0.1 of a foot. Such price and payment shall be full compensation for fabricating, furnishing, installing, painting, anchoring and all incidentals necessary to satisfactorily install the handrail.

Payment will be made under:

Pay Item	Pay Unit
Pedestrian Safety Rail	Linear Foot

FOUNDATIONS AND ANCHOR ROD ASSEMBLIES FOR METAL POLES:

(1-17-12)(Rev. 1-16-24)

9, 14, 17

SP9 R05

Description

Foundations for metal poles include foundations for signals, cameras, overhead and dynamic message signs (DMS) and high mount and light standards supported by metal poles or upright trusses. Foundations consist of footings with pedestals and drilled piers with or without grade beams or wings. Anchor rod assemblies consist of anchor rods (also called anchor bolts) with nuts and washers on the exposed ends of rods and nuts and a plate or washers on the other ends of rods embedded in the foundation.

Construct concrete foundations with the required resistances and dimensions and install anchor rod assemblies in accordance with the contract and accepted submittals. Construct drilled piers

consisting of cast-in-place reinforced concrete cylindrical sections in excavated holes. Provide temporary casings or polymer slurry as needed to stabilize drilled pier excavations. Use a prequalified Drilled Pier Contractor to construct drilled piers for metal poles. Define “excavation” and “hole” as a drilled pier excavation and “pier” as a drilled pier.

This provision does not apply to foundations for signal pedestals; see Section 1743 of the *Standard Specifications* and Roadway Standard Drawing No. 1743.01.

Materials

Refer to the *Standard Specifications*.

Item	Section
Conduit	1091-3
Grout, Type 2	1003
Polymer Slurry	411-2(B)(2)
Portland Cement Concrete	1000
Reinforcing Steel	1070
Rollers and Chairs	411-2(C)
Temporary Casings	411-2(A)

Provide Type 3 material certifications in accordance with Article 106-3 of the *Standard Specifications* for conduit, rollers, chairs and anchor rod assemblies. Store steel materials on blocking at least 12" above the ground and protect it at all times from damage; and when placing in the work make sure it is free from dirt, dust, loose mill scale, loose rust, paint, oil or other foreign materials. Load, transport, unload and store foundation and anchor rod assembly materials so materials are kept clean and free of damage. Bent, damaged or defective materials will be rejected.

Use conduit type in accordance with the contract. Use Class A concrete for footings and pedestals, Class Drilled Pier concrete for drilled piers and Class AA concrete for grade beams and wings including portions of drilled piers above bottom of wings elevations. Corrugated temporary casings may be accepted at the discretion of the Engineer. A list of approved polymer slurry products is available from:

connect.ncdot.gov/resources/Geological/Pages/Products.aspx

Provide anchor rod assemblies in accordance with the contract consisting of the following:

- (A) Straight anchor rods,
- (B) Heavy hex top and leveling nuts and flat washers on exposed ends of rods, and
- (C) Nuts and either flat plates or washers on the other ends of anchor rods embedded in foundations.

Do not use lock washers. Use steel anchor rods, nuts and washers that meet ASTM F1554 for Grade 55 rods and Grade A nuts. Use steel plates and washers embedded in concrete with a thickness of at least 1/4". Galvanize anchor rods and exposed nuts and washers in accordance

with Article 1076-4 of the *Standard Specifications*. It is not necessary to galvanize nuts, plates and washers embedded in concrete.

Construction Methods

Install the required size and number of conduits in foundations in accordance with the plans and accepted submittals. Construct top of piers, footings, pedestals, grade beams and wings flat, level and within 1" of elevations shown in the plans or approved by the Engineer. Provide an Ordinary Surface finish in accordance with Subarticle 825-6(B) of the *Standard Specifications* for portions of foundations exposed above finished grade. Do not remove anchor bolt templates or pedestal or grade beam forms or erect metal poles or upright trusses onto foundations until concrete attains a compressive strength of at least 3,000 psi.

(A) Drilled Piers

Before starting drilled pier construction, hold a predrill meeting to discuss the installation, monitoring and inspection of the drilled piers. Schedule this meeting after the Drilled Pier Contractor has mobilized to the site. The Resident or Division Traffic Engineer, Contractor and Drilled Pier Contractor Superintendent will attend this predrill meeting.

Do not excavate holes, install piles or allow equipment wheel loads or vibrations within 20 ft of completed piers until 16 hours after Drilled Pier concrete reaches initial set.

Check for correct drilled pier alignment and location before beginning drilling. Check plumbness of holes frequently during drilling.

Construct drilled piers with the minimum required diameters shown in the plans. Install piers with tip elevations no higher than shown in the plans or approved by the Engineer.

Excavate holes with equipment of the sizes required to construct drilled piers. Depending on the subsurface conditions encountered, drilling through rock and boulders may be required. Do not use blasting for drilled pier excavations.

Contain and dispose of drilling spoils and waste concrete as directed and in accordance with Section 802 of the *Standard Specifications*. Drilling spoils consist of all materials and fluids removed from excavations.

If unstable, caving or sloughing materials are anticipated or encountered, stabilize holes with temporary casings and/or polymer slurry. Do not use telescoping temporary casings. If it becomes necessary to replace a temporary casing during drilling, backfill the excavation, insert a larger casing around the casing to be replaced or stabilize the excavation with polymer slurry before removing the temporary casing.

If temporary casings become stuck or the Contractor proposes leaving casings in place, temporary casings should be installed against undisturbed material. Unless otherwise approved, do not leave temporary casings in place for mast arm poles and cantilever

signs. The Engineer will determine if casings may remain in place. If the Contractor proposes leaving temporary casings in place, do not begin drilling until a casing installation method is approved.

Use polymer slurry and additives to stabilize holes in accordance with the slurry manufacturer's recommendations. Provide mixing water and equipment suitable for polymer slurry. Maintain the required slurry properties at all times except for sand content.

Define a "sample set" as slurry samples collected from mid-height and within 2 ft of the bottom of holes. Take sample sets from excavations to test polymer slurry immediately after filling holes with slurry, at least every 4 hours thereafter and immediately before placing concrete. Do not place Drilled Pier concrete until both slurry samples from an excavation meet the required polymer slurry properties. If any slurry test results do not meet the requirements, the Engineer may suspend drilling until both samples from a sample set meet the required polymer slurry properties.

Remove soft and loose material from bottom of holes using augers to the satisfaction of the Engineer. Assemble rebar cages and place cages and Drilled Pier concrete in accordance with Subarticle 411-4(E) of the *Standard Specifications* except for the following:

- (1) Inspections for tip resistance and bottom cleanliness are not required,
- (2) Temporary casings may remain in place if approved, and
- (3) Concrete placement may be paused near the top of pier elevations for anchor rod assembly installation and conduit placement or
- (4) If applicable, concrete placement may be stopped at bottom of grade beam or wings elevations for grade beam or wing construction.

If wet placement of concrete is anticipated or encountered, do not place Drilled Pier concrete until a concrete placement procedure is approved. If applicable, temporary casings and fluids may be removed when concrete placement is paused or stopped in accordance with the exceptions above provided holes are stable. Remove contaminated concrete from exposed Drilled Pier concrete after removing casings and fluids. If holes are unstable, do not remove temporary casings until a procedure for placing anchor rod assemblies and conduit or constructing grade beams or wings is approved.

Use collars to extend drilled piers above finished grade. Remove collars after Drilled Pier concrete sets and round top edges of piers.

If drilled piers are questionable, pile integrity testing (PIT) and further investigation may be required in accordance with Article 411-5 of the *Standard Specifications*. A drilled pier will be considered defective in accordance with Subarticle 411-5(D) of the *Standard Specifications* and drilled pier acceptance is based in part on the criteria in Article 411-6 of the *Standard Specifications* except for the top of pier tolerances in Subarticle 411-6(C) of the *Standard Specifications*.

If a drilled pier is under further investigation, do not grout core holes, backfill around the pier or perform any work on the drilled pier until the Engineer accepts the pier. If the drilled pier is accepted, dewater and grout core holes and backfill around the pier with approved material to finished grade. If the Engineer determines a pier is unacceptable, remediation is required in accordance with Article 411-6 of the *Standard Specifications*. No extension of completion date or time will be allowed for remediation of unacceptable drilled piers or post repair testing.

Permanently embed a plate in or mark top of piers with the pier diameter and depth, size and number of vertical reinforcing bars and the minimum compressive strength of the concrete mix at 28 days.

(B) Footings, Pedestals, Grade Beams and Wings

Excavate as necessary for footings, grade beams and wings in accordance with the plans, accepted submittals and Section 410 of the *Standard Specifications*. If unstable, caving or sloughing materials are anticipated or encountered, shore foundation excavations as needed with an approved method. Notify the Engineer when foundation excavation is complete. Do not place concrete or reinforcing steel until excavation dimensions and foundation material are approved.

Construct cast-in-place reinforced concrete footings, pedestals, grade beams and wings with the dimensions shown in the plans and in accordance with Section 825 of the *Standard Specifications*. Use forms to construct portions of pedestals and grade beams protruding above finished grade. Provide a chamfer with a 3/4" horizontal width for pedestal and grade beam edges exposed above finished grade. Place concrete against undisturbed soil or backfill and fill in accordance with Article 410-8 of the *Standard Specifications*. Proper compaction around footings and wings is critical for foundations to resist uplift and torsion forces.

(C) Anchor Rod Assemblies

Size anchor rods for design and the required projection above top of foundations. Determine required anchor rod projections from nut, washer and base plate thicknesses, the protrusion of 3 to 5 anchor rod threads above top nuts after tightening and the distance of one nut thickness between top of foundations and bottom of leveling nuts.

Protect anchor rod threads from damage during storage and installation of anchor rod assemblies. Before placing anchor rods in foundations, turn nuts onto and off rods past leveling nut locations. Turn nuts with the effort of one workman using an ordinary wrench without a cheater bar. Report any thread damage to the Engineer that requires extra effort to turn nuts.

Arrange anchor rods symmetrically about center of base plate locations as shown in the plans. Set anchor rod elevations based on required projections above top of foundations. Securely brace and hold rods in the correct position, orientation and alignment with a steel template. Do not weld to reinforcing steel, temporary casings or anchor rods.

Install top and leveling (bottom) nuts, washers and the base plate for each anchor rod assembly in accordance with the following procedure:

- (1) Turn leveling nuts onto anchor rods to a distance of one nut thickness between the top of foundation and bottom of leveling nuts. Place washers over anchor rods on top of leveling nuts.
- (2) Determine if nuts are level using a flat rigid template on top of washers. If necessary, lower leveling nuts to level the template in all directions or if applicable, lower nuts to tilt the template so the metal pole or upright truss will lean as shown in the plans. If leveling nuts and washers are not in full contact with the template, replace washers with galvanized beveled washers.
- (3) Verify the distance between the foundation and leveling nuts is no more than one nut thickness.
- (4) Place base plate with metal pole or upright truss over anchor rods on top of washers. High mount luminaires may be attached before erecting metal poles but do not attach cables, mast arms or trusses to metal poles or upright trusses at this time.
- (5) Place washers over anchor rods on top of base plate. Lubricate top nut bearing surfaces and exposed anchor rod threads above washers with beeswax, paraffin or other approved lubricant.
- (6) Turn top nuts onto anchor rods. If nuts are not in full contact with washers or washers are not in full contact with the base plate, replace washers with galvanized beveled washers.
- (7) Tighten top nuts to snug-tight with the full effort of one workman using a 12" wrench. Do not tighten any nut all at once. Turn top nuts in increments. Follow a star pattern cycling through each nut at least twice.
- (8) Repeat (7) for leveling nuts.
- (9) Replace washers above and below the base plate with galvanized beveled washers if the slope of any base plate face exceeds 1:20 (5%), any washer is not in firm contact with the base plate or any nut is not in firm contact with a washer. If any washers are replaced, repeat (7) and (8).
- (10) With top and leveling nuts snug-tight, mark each top nut on a corner at the intersection of 2 flats and a corresponding reference mark on the base plate. Mark top nuts and base plate with ink or paint that is not water-soluble. Use the turn-of-nut method for pretensioning. Do not pretension any nut all at once. Turn top nuts in increments for a total turn that meets the following nut rotation requirements:

NUT ROTATION REQUIREMENTS (Turn-of-Nut Pretensioning Method)	
Anchor Rod Diameter, inch	Requirement
$\leq 1 \frac{1}{2}$	1/3 turn (2 flats)
$> 1 \frac{1}{2}$	1/6 turn (1 flat)

Follow a star pattern cycling through each top nut at least twice.

- (11) Ensure nuts, washers and base plate are in firm contact with each other for each anchor rod. Cables, mast arms and trusses may now be attached to metal poles and upright trusses.
- (12) Between 4 and 14 days after pretensioning top nuts, use a torque wrench

calibrated within the last 12 months to check nuts in the presence of the Engineer. Completely erect mast arm poles and cantilever signs and attach any hardware before checking top nuts for these structures. Check that top nuts meet the following torque requirements:

TORQUE REQUIREMENTS	
Anchor Rod Diameter, inch	Requirement, ft-lb
7/8	180
1	270
1 1/8	380
1 1/4	420
$\geq 1\ 1/2$	600

If necessary, retighten top nuts in the presence of the Engineer with a calibrated torque wrench to within ± 10 ft-lb of the required torque. Do not overtighten top nuts.

- (13) Do not grout under base plate.

Measurement and Payment

Foundations and anchor rod assemblies for metal poles and upright trusses will be measured and paid for elsewhere in the contract.

No payment will be made for temporary casings that remain in drilled pier excavations. No payment will be made for PIT. No payment will be made for further investigation of defective piers. Further investigation of piers that are not defective will be paid as extra work in accordance with Article 104-7 of the *Standard Specifications*. No payment will be made for remediation of unacceptable drilled piers or post repair testing.

ELECTRONIC TICKETING SYSTEM:

(7-16-24)

1020

SP10 R20

Description

At the contractor's option, the use of an electronic ticketing system for reporting individual and cumulative asphalt material deliveries may be utilized on this project. At the preconstruction conference, the contractor shall notify the Engineer if they intend to utilize an electronic ticketing system for reporting individual and cumulative asphalt material deliveries to the project.

Electronic Ticketing Requirements

- a. The electronic ticketing system must be fully integrated with the load read-out system at the plant. The system shall be designed so data inputs from scales cannot be altered by either the Contractor or the Department.
- b. Material supplier must test to confirm that ticketing data can be shared from the originating system no less than 30 days prior to project start.

- c. After each truck is loaded, ticket data must be electronically captured, and ticket information uploaded via Application Programming Interface (API) to the Department.
- d. Obtain security token from NCDOT for access to E-Ticketing portal (to send tickets). To request a Security Key, fill out the below E-Ticketing Security Request Form: <https://forms.office.com/g/XnT7QeRtgt>
- e. Obtain API from NCDOT containing the required e-ticketing data fields and format. Download the API from the NCDOT E-ticketing Webpage: <https://connect.ncdot.gov/projects/construction/E-Ticketing/Pages/default.aspx>
- f. Provide all ticket information in real time and daily summaries to the Department's designated web portal. If the project contains locations with limited cellular service, an alternative course of action must be agreed upon.
- g. Electronic ticketing submissions must be sent between the Material Supplier and the Department.
- h. The electronic ticket shall contain the following information:

Date
Time
Contract Number
Supplier Name
Contractor Name
Material
JMF
Gross Weight
Tare Weight
Net Weight
Load Number
Cumulative Weight
Truck Number
Weighmaster Certification
Weighmaster Expiration
Weighmaster Name
Facility Name
Plant Type
Plant Number
Ticket Number
Voided Ticket Number (if necessary)
Original Ticket Number (if necessary)
Supplier Revision (If necessary)

The Contractor/supplier can use the electronic ticketing system of their choice to meet the requirements of this provision.

Measurement and Payment

No measurement or payment will be made for utilizing an electronic ticketing system as the cost of such shall be included in the contract price bid for the material being provided.

GLASS BEAD GRADATION FOR PAVEMENT MARKINGS:

(9-17-24)

1087

SP10 R87

Revise the *Standard Specifications* as follows:

Page 10-187, Subarticle 1087-4(C), Gradation & Roundness, after line 6, delete and replace Table 1087-2 with the following:

TABLE 1087-2 GLASS BEAD GRADATION REQUIREMENTS		
Sieve Size	Gradation Requirements	
	Minimum	Maximum
Passing #20	100%	--
Retained on #30	5%	15%
Retained on #50	40%	80%
Retained on #80	15%	40%
Passing #80	0%	10%
Retained on #200	0%	5%

SNOWPLOWABLE DELINEATION:

(10-15-24)

1253

SP12 R53

Description

Furnish, install and maintain snowplowable delineation.

There are five snowplowable delineation alternate options approved for use in North Carolina. They include the following markers and markings options:

- (1) Polycarbonate H-shaped Markers
- (2) Inlaid Raised Pavement Markers
- (3) 10' Rumble Skips
- (4) Inlaid Cradle Markers
- (5) 10' Inlaid Pavement Markings

Only one type of snowplowable delineation will be allowed on a single project.

Materials

Refer to Division 10 of the *Standard Specifications*.

Item	Section
Epoxy	1081
Pavement Markings	1087
Snowplowable Pavement Markers	1086-3

Any snowplowable pavement delineation shall conform to the applicable requirements of Sections 1086, 1087, and 1081 of the *Standards and Specifications*. Use snowplowable delineation markers and markings listed on the NCDOT APL. Any treatment that requires pavement cutting or milling shall be installed within 7 calendar days of the pavement cutting or milling operation.

Construction Methods

(A) General

For any snowplowable delineation, prior to installation, by brushing, blow cleaning, vacuuming or other suitable means, ensure that all materials and the pavement surface are free of dirt, grease, dust, oil, moisture, mud, grass, or any other material that would prevent adhesion to the pavement by brushing blow cleaning, or vacuuming. If required, apply a primer per manufactures recommendations to pavement surfaces before applying pavement marking material.

Install snowplowable delineation per manufacturers specifications every 80 feet. Make sure pavement markers are oriented to traffic correctly and pavement markings are applied in a uniform thickness. Do not apply markings over longitudinal joints. Protect the pavement markings until they are tack free. Apply applicable Sections 1205 and 1250 of the *Standards Specifications*.

If damage occurs during installation the effected treatments shall be corrected or replaced. This work shall be considered incidental to the installation of the marking or marker.

(B) Polycarbonate H-shaped Markers and Inlaid Cradle Markers

Bond marker housings to the pavement with epoxy adhesive. Mechanically mix and dispense epoxy adhesives as required by the manufacturer's specifications. Place the markers immediately after the adhesive has been mixed and dispensed.

Install polycarbonate H-shaped markers and inlaid cradle markers castings into slots sawcut into the pavement. Make slots in the pavement to exactly duplicate the shape of the casting of the polycarbonate H-shaped markers and inlaid cradle markers.

If saw cutting, milling, or grooving operations are used, promptly remove all resulting debris from the pavement surface. Install the marker housings within 7 calendar days after saw cutting , milling, or grooving the pavement. Remove and dispose of loose material from the slots by brushing, blow cleaning or vacuuming. Dry the slots before applying the epoxy adhesive. Install polycarbonate H-shaped markers and inlaid cradle markers according to the manufacturer's recommendations.

Protect the polycarbonate H-shaped markers or inlaid cradle markers until the epoxy has initially cured and is track free.

Construct inlaid cradle markers in accordance with the details in the plans and as directed by the Engineer.

(C) Reflector Replacement

The following requirements only apply to polycarbonate H-shaped markers and inlaid cradle markers.

In the event that a reflector is damaged, replace the damaged reflector by using adhesives and methods recommended by the manufacturer of the markers and approved by the Engineer. This work is considered incidental if damage occurs during the initial installation of the marker housings and maintenance of initial polycarbonate H-shaped markers or inlaid cradle markers specified in this section.

If during reflector replacement it is discovered that the housing is missing or broken this will be paid as *Polycarbonate H-shaped Markers* or *Inlaid Cradle Markers*. Missing housings shall be replaced. Broken housings shall be removed and replaced. In both cases the slot for the housings shall be properly prepared prior to installing the new housing; patch the existing marker slots as directed by the Engineer and install the new marker approximately one foot before or after the patch. Removal of broken housings and preparation of slots will be considered incidental to the work of replacing housings.

(D) Inlaid Raised Pavement Markers

Cut groove in accordance with the details in the plans and as directed by the Engineer.

Use adhesive recommended by the manufacturer to install markers into the groove in accordance with Section 1251. The raised pavement markers are incidental to inlaid raised pavement markers.

(E) 10' Rumble Skips

Construct 10' rumble skips on asphalt concrete in accordance with Section 665 for all centerline and shoulder rumble skips, details in the plans and as directed by the Engineer. Construct 10' rumble skips on Portland cement concrete in accordance with Section 730 for all centerline and shoulder rumble skips, details in the plans and as directed by the Engineer. The milled rumble strips are incidental to the rumble skips. Using polyurea or extruded 90 mil thermoplastic construct pavement markings in accordance with Section 1205.

(F) 10' Inlaid Pavement Markings

The groove in which the marking is to be placed shall be one inch wider than the marking to be placed and 10 mils deeper than the thickness of the marking.

When using this method, use enhanced reflective media. The following retroreflectivity values shall be met.

MINIMUM INITIAL REFLECTOMETER READINGS		
Item	Color	Reflectivity
Enhanced Reflectivity Media	White	450 mcd/lux/m ²
	Yellow	350 mcd/lux/m ²

Using polyurea, extruded 90 mil thermoplastic or cold applied plastic construct pavement markings in accordance with Section 1205.

Maintenance

Maintain all installed snowplowable delineation before acceptance by the Engineer.

Measurement and Payment

Polycarbonate H-shaped Markers will be measured and paid as the actual number of polycarbonate H-shaped markers satisfactorily placed and accepted by the Engineer.

Inlaid Raised Pavement Markers will be measured and paid as the actual number of inlaid raised pavement markers satisfactorily placed and accepted by the Engineer.

10' Rumble Skips will be measured and paid as the actual number of rumble skips satisfactorily placed and accepted by the Engineer.

Inlaid Cradle Markers will be measured and paid as the actual number of pavement markers satisfactorily placed and accepted by the Engineer.

10' Inlaid Pavement Markings will be measured and paid as the actual number of 10' inlaid pavement markings satisfactorily placed and accepted by the Engineer.

Replace Snowplowable Pavement Marker Reflector will be measured and paid in accordance with Article 1253-5.

Payment will be made under:

Pay Item	Pay Unit
Polycarbonate H-shaped Markers	Each
Inlaid Raised Pavement Markers	Each
10' Rumble Skips	Each
Inlaid Cradle Markers	Each
10' Inlaid Pavement Markings	Each

WATTLE DEVICES:

(1-1-24)

1642

SP16 R01

Page 16-23, Subarticle 1642-2(B) Wattle, lines 10-12, delete and replace with the following:

(B) Wattle and Wattle Barrier

Wattles shall meet Table 1642-1.

TABLE 1642-1	
100% CURLED WOOD (EXCELSIOR) FIBERS - WATTLE	
Property	Property Value
Minimum Diameter	12 inches
Minimum Density	2.5 pcf +/- 10%
Net Material	Synthetic
Net Openings	1 inch x 1 inch
Net Configuration	Totally Encased
Minimum Weight	20 lb +/- 10% per 10 foot length

Coir Fiber Wattles shall meet Table 1642-2.

TABLE 1642-2	
100% COIR (COCONUT) FIBERS WATTLE	
Property	Property Value
Minimum Diameter	12 inches
Minimum Density	3.5 pcf +/- 10%
Net Material	Coir Fiber
Net Openings	2 inch x 2 inch
Net Strength	90 lb
Minimum Weight	2.6 pcf +/- 10%

Wattle Barriers shall meet Table 1642-3.

TABLE 1642-3	
100% CURLED WOOD (EXCELSIOR) FIBERS – WATTLE BARRIER	
Property	Property Value
Minimum Diameter	18 inches
Minimum Density	2.9 pcf +/- 10%
Net Material	Synthetic
Net Openings	1 inch x 1 inch
Net Configuration	Totally Encased
Minimum Weight	5 pcf +/- 10%

Coir Fiber Wattle Barriers shall meet Table 1642-4.

TABLE 1642-4	
100% COIR (COCONUT) FIBERS WATTLE BARRIER	
Property	Property Value
Minimum Diameter	18 inches
Minimum Density	5 pcf +/- 10%
Net Material	Coir Fiber
Net Openings	2 inch x 2 inch
Net Strength	90 lb
Minimum Weight	10 pcf +/- 10%

Pages 16-24 & 16-25, Article 1642-5 MEASUREMENT AND PAYMENT, lines 42-47 & lines 1-2, delete and replace with the following:

Wattle will be measured and paid for by the actual number of linear feet of wattles which are installed and accepted. Such price and payment will be full compensation for all work covered by this section, including, but not limited to, furnishing all materials, labor, equipment and incidentals necessary to install the *Wattle*.

Coir Fiber Wattles will be measured and paid for by the actual number of linear feet of coir fiber wattles which are installed and accepted. Such price and payment will be full compensation for all work covered by this section, including, but not limited to, furnishing all materials, labor, equipment and incidentals necessary to install the *Coir Fiber Wattles*.

Wattle Barrier will be measured and paid as the actual number of linear feet of wattle barrier installed and accepted. Such price and payment will be full compensation for all work covered by this provision, including, but not limited to, furnishing all materials, labor, equipment and incidentals necessary to install the *Wattle Barrier*.

Coir Fiber Wattle Barrier will be measured and paid as the actual number of linear feet of coir fiber wattle barrier installed and accepted. Such price and payment will be full compensation for all work covered by this provision, including, but not limited to, furnishing all materials, labor, equipment and incidentals necessary to install the *Coir Fiber Wattle Barrier*.

Page 16-25, Article 1642-5 MEASUREMENT AND PAYMENT, after line 9, delete and replace “ ___ Wattle Check” with “Wattle”.

Page 16-25, Article 1642-5 MEASUREMENT AND PAYMENT, after line 9, delete and replace “ ___ Wattle Barrier” with “Wattle Barrier”.

Page 16-25, Article 1642-5 MEASUREMENT AND PAYMENT, after line 9, add the following:

Pay Item	Pay Unit
Coir Fiber Wattle	Linear Foot
Coir Fiber Wattle Barrier	Linear Foot

PERMANENT SEEDING AND MULCHING:

(7-1-95)(Rev. 1-16-24)

1660

SP16 R02

The Department desires that permanent seeding and mulching be established on this project as soon as practical after slopes or portions of slopes have been graded. As an incentive to obtain an early stand of vegetation on this project, the Contractor's attention is called to the following:

For all permanent seeding and mulching that is satisfactorily completed in accordance with the requirements of Section 1660 in the *Standard Specifications* and within the following percentages of elapsed contract times, an additional payment will be made to the Contractor as an incentive additive. The incentive additive will be determined by multiplying the number of

acres of seeding and mulching satisfactorily completed times the contract unit bid price per acre for Seeding and Mulching times the appropriate percentage additive.

Percentage of Elapsed Contract Time	Percentage Additive
0% - 30%	30%
30.01% - 50%	15%

Percentage of elapsed contract time is defined as the number of calendar days from the date of availability of the contract to the date the permanent seeding and mulching is acceptably completed divided by the total original contract time.

STANDARD SPECIAL PROVISION**AVAILABILITY OF FUNDS – TERMINATION OF CONTRACTS**

(5-20-08)(Rev. 1-16-24)

Z-2

General Statute 143C-6-11. (h) Highway Appropriation is hereby incorporated verbatim in this contract as follows:

(h) Amounts Encumbered. – Transportation project appropriations may be encumbered in the amount of allotments made to the Department of Transportation by the Director for the estimated payments for transportation project contract work to be performed in the appropriation fiscal year. The allotments shall be multiyear allotments and shall be based on estimated revenues and shall be subject to the maximum contract authority contained in *General Statute 143C-6-11(c)*. Payment for transportation project work performed pursuant to contract in any fiscal year other than the current fiscal year is subject to appropriations by the General Assembly. Transportation project contracts shall contain a schedule of estimated completion progress, and any acceleration of this progress shall be subject to the approval of the Department of Transportation provided funds are available. The State reserves the right to terminate or suspend any transportation project contract, and any transportation project contract shall be so terminated or suspended if funds will not be available for payment of the work to be performed during that fiscal year pursuant to the contract. In the event of termination of any contract, the contractor shall be given a written notice of termination at least 60 days before completion of scheduled work for which funds are available. In the event of termination, the contractor shall be paid for the work already performed in accordance with the contract specifications.

Payment will be made on any contract terminated pursuant to the special provision in accordance with Subarticle 108-13(D) of the *Standard Specifications*.

STANDARD SPECIAL PROVISION
NCDOT GENERAL SEED SPECIFICATION FOR SEED QUALITY

(5-17-11)

Z-3

Seed shall be sampled and tested by the North Carolina Department of Agriculture and Consumer Services, Seed Testing Laboratory. When said samples are collected, the vendor shall supply an independent laboratory report for each lot to be tested. Results from seed so sampled shall be final. Seed not meeting the specifications shall be rejected by the Department of Transportation and shall not be delivered to North Carolina Department of Transportation warehouses. If seed has been delivered it shall be available for pickup and replacement at the supplier's expense.

Any re-labeling required by the North Carolina Department of Agriculture and Consumer Services, Seed Testing Laboratory, that would cause the label to reflect as otherwise specified herein shall be rejected by the North Carolina Department of Transportation.

Seed shall be free from seeds of the noxious weeds Johnsongrass, Balloonvine, Jimsonweed, Witchweed, Itchgrass, Serrated Tussock, Showy Crotalaria, Smooth Crotalaria, Sicklepod, Sandbur, Wild Onion, and Wild Garlic. Seed shall not be labeled with the above weed species on the seed analysis label. Tolerances as applied by the Association of Official Seed Analysts will NOT be allowed for the above noxious weeds except for Wild Onion and Wild Garlic.

Tolerances established by the Association of Official Seed Analysts will generally be recognized. However, for the purpose of figuring pure live seed, the found pure seed and found germination percentages as reported by the North Carolina Department of Agriculture and Consumer Services, Seed Testing Laboratory will be used. Allowances, as established by the NCDOT, will be recognized for minimum pure live seed as listed on the following pages.

The specifications for restricted noxious weed seed refers to the number per pound as follows:

<u>Restricted Noxious Weed</u>	<u>Limitations per Lb. Of Seed</u>	<u>Restricted Noxious Weed</u>	<u>Limitations per Lb. of Seed</u>
Blessed Thistle	4 seeds	Cornflower (Ragged Robin)	27 seeds
Cocklebur	4 seeds	Texas Panicum	27 seeds
Spurred Anoda	4 seeds	Bracted Plantain	54 seeds
Velvetleaf	4 seeds	Buckhorn Plantain	54 seeds
Morning-glory	8 seeds	Broadleaf Dock	54 seeds
Corn Cockle	10 seeds	Curly Dock	54 seeds
Wild Radish	12 seeds	Dodder	54 seeds
Purple Nutsedge	27 seeds	Giant Foxtail	54 seeds
Yellow Nutsedge	27 seeds	Horsenettle	54 seeds
Canada Thistle	27 seeds	Quackgrass	54 seeds
Field Bindweed	27 seeds	Wild Mustard	54 seeds
Hedge Bindweed	27 seeds		

Seed of Pensacola Bahiagrass shall not contain more than 7% inert matter, Kentucky Bluegrass, Centipede and Fine or Hard Fescue shall not contain more than 5% inert matter whereas a maximum of 2% inert matter will be allowed on all other kinds of seed. In addition, all seed

shall not contain more than 2% other crop seed nor more than 1% total weed seed. The germination rate as tested by the North Carolina Department of Agriculture shall not fall below 70%, which includes both dormant and hard seed. Seed shall be labeled with not more than 7%, 5% or 2% inert matter (according to above specifications), 2% other crop seed and 1% total weed seed.

Exceptions may be made for minimum pure live seed allowances when cases of seed variety shortages are verified. Pure live seed percentages will be applied in a verified shortage situation. Those purchase orders of deficient seed lots will be credited with the percentage that the seed is deficient.

FURTHER SPECIFICATIONS FOR EACH SEED GROUP ARE GIVEN BELOW:

Minimum 85% pure live seed; maximum 1% total weed seed; maximum 2% total other crop seed; maximum 144 restricted noxious weed seed per pound. Seed less than 83% pure live seed will not be approved.

Sericea Lespedeza
Oats (seeds)

Minimum 80% pure live seed; maximum 1% total weed seed; maximum 2% total other crop; maximum 144 restricted noxious weed seed per pound. Seed less than 78% pure live seed will not be approved.

Tall Fescue (all approved varieties)	Bermudagrass
Kobe Lespedeza	Browntop Millet
Korean Lespedeza	German Millet – Strain R
Weeping Lovegrass	Clover – Red/White/Crimson
Carpetgrass	

Minimum 78% pure live seed; maximum 1% total weed seed; maximum 2% total other crop seed; maximum 144 restricted noxious weed seed per pound. Seed less than 76% pure live seed will not be approved.

Common or Sweet Sundangrass

Minimum 76% pure live seed; maximum 1% total weed seed; maximum 2% total other crop seed; maximum 144 restricted noxious weed seed per pound. Seed less than 74% pure live seed will not be approved.

Rye (grain; all varieties)
Kentucky Bluegrass (all approved varieties)
Hard Fescue (all approved varieties)
Shrub (bicolor) Lespedeza

Minimum 70% pure live seed; maximum 1% total weed seed; maximum 2% total other crop seed; maximum 144 noxious weed seed per pound. Seed less than 70% pure live seed will not be approved.

Centipedegrass	Japanese Millet
Crownvetch	Reed Canary Grass
Pensacola Bahiagrass	Zoysia

Creeping Red Fescue

Minimum 70% pure live seed; maximum 1% total weed seed; maximum 2% total other crop seed; maximum 5% inert matter; maximum 144 restricted noxious weed seed per pound.

Barnyard Grass
Big Bluestem
Little Bluestem
Bristly Locust
Birdsfoot Trefoil
Indiangrass
Orchardgrass
Switchgrass
Yellow Blossom Sweet Clover

STANDARD SPECIAL PROVISION
ERRATA

(1-16-24)

Z-4

Revise the *2024 Standard Specifications* as follows:

Division 3

Page 3-5, Article 305-2 MATERIALS, after line 16, replace " 1032-3(A)(7)" with "1032-3" and add the item "Galvanized Corrugated Steel Pipe" with Section "1032-3".

Page 3-6, Article 310-2 MATERIALS, after line 9, add the item "Galvanized Corrugated Steel Pipe" with Section "1032-3".

Division 9

Page 9-17, Article 904-4 MEASUREMENT AND PAYMENT, prior to line 1, replace " Sign Erection, Relocate Type (Ground Mounted)" with "Sign Erection, Relocate Type ___ (Ground Mounted)".

Division 10

Page 10-51, Article 1024-4 WATER, prior to line 1, delete the "unpopulated blank row" in Table 1024-2 between "Time of set, deviation from control" and "Chloride Ion Content, Max.".

Page 10-170, Subarticle 1081-1(C) Requirements, line 4, replace "maximum" with "minimum".

Division 11

Page 11-15, Article 1160-4 MEASUREMENT AND PAYMENT, line 24, replace "Where barrier units are moved more than one" with "Where barrier units are moved more than once".

Division 15

Page 15-10, Article 1515-4 MEASUREMENT AND PAYMENT, lines 11, replace " All piping" with "All labor, the manhole, other materials, excavation, backfilling, piping".

Division 16

Page 16-14, Article 1633-5 MEASUREMENT AND PAYMENT, line 20-24 and prior to line 25, delete and replace with the following " *Flocculant* will be measured and paid in accordance with Article 1642-5 applied to the temporary rock silt checks."

Page 16-3, Article 1609-2 MATERIALS, after line 26, replace "Type 4" with "Type 4a".

Page 16-25, Article 1644-2 MATERIALS, after line 22, replace "Type 4" with "Type 4a".

STANDARD SPECIAL PROVISION**PLANT AND PEST QUARANTINES****(Imported Fire Ant, Gypsy Moth, Witchweed, Emerald Ash Borer, Guava Root Knot Nematode, And Other Noxious Weeds)**

(3-18-03) (Rev. 5-21-19)

Z-04a

Within Quarantined Area

This project may be within a county regulated for plant and/or pests. If the project or any part of the Contractor's operations is located within a quarantined area, thoroughly clean all equipment prior to moving out of the quarantined area. Comply with federal/state regulations by obtaining a certificate or limited permit for any regulated article moving from the quarantined area.

Originating in a Quarantined County

Obtain a certificate or limited permit issued by the N.C. Department of Agriculture/United States Department of Agriculture. Have the certificate or limited permit accompany the article when it arrives at the project site.

Contact

Contact the N.C. Department of Agriculture/United States Department of Agriculture at 1-800-206-9333, 919-707-3730, or <https://www.ncagr.gov/plantindustry/Plant/quaran/table2.htm> to determine those specific project sites located in the quarantined area or for any regulated article used on this project originating in a quarantined county.

Regulated Articles Include

1. Soil, sand, gravel, compost, peat, humus, muck, and decomposed manure, separately or with other articles. This includes movement of articles listed above that may be associated with cut/waste, ditch pulling, and shoulder cutting.
2. Plants with roots including grass sod.
3. Plant crowns and roots.
4. Bulbs, corms, rhizomes, and tubers of ornamental plants.
5. Hay, straw, fodder, and plant litter of any kind.
6. Clearing and grubbing debris.
7. Used agricultural cultivating and harvesting equipment.
8. Used earth-moving equipment.
9. Any other products, articles, or means of conveyance, of any character, if determined by an inspector to present a hazard of spreading imported fire ant, gypsy moth, witchweed, emerald ash borer, guava root knot nematode, or other noxious weeds.

STANDARD SPECIAL PROVISION

MINIMUM WAGES

(7-21-09)

Z-5

FEDERAL: The Fair Labor Standards Act provides that with certain exceptions every employer shall pay wages at the rate of not less than SEVEN DOLLARS AND TWENTY FIVE CENTS (\$7.25) per hour.

STATE: The North Carolina Minimum Wage Act provides that every employer shall pay to each of his employees, wages at a rate of not less than SEVEN DOLLARS AND TWENTY FIVE CENTS (\$7.25) per hour.

The minimum wage paid to all skilled labor employed on this contract shall be SEVEN DOLLARS AND TWENTY FIVE CENTS (\$7.25) per hour.

The minimum wage paid to all intermediate labor employed on this contract shall be SEVEN DOLLARS AND TWENTY FIVE CENTS (\$7.25) per hour.

The minimum wage paid to all unskilled labor on this contract shall be SEVEN DOLLARS AND TWENTY FIVE CENTS (\$7.25) per hour.

This determination of the intent of the application of this act to the contract on this project is the responsibility of the Contractor.

The Contractor shall have no claim against the Department of Transportation for any changes in the minimum wage laws, Federal or State. It is the responsibility of the Contractor to keep fully informed of all Federal and State Laws affecting his contract.

STANDARD SPECIAL PROVISION**TITLE VI AND NONDISCRIMINATION:**

(6-28-77)(Rev 1/16/2024)

Z-6

The North Carolina Department of Transportation is committed to carrying out the U.S. Department of Transportation's policy of ensuring nondiscrimination in the award and administration of contracts.

The provisions of this section related to United States Department of Transportation (US DOT) Order 1050.2A, Title 49 Code of Federal Regulations (CFR) part 21, 23 United States Code (U.S.C.) 140 and 23 CFR part 200 (or 49 CFR 303, 49 U.S.C. 5332 or 49 U.S.C. 47123) are applicable to all North Carolina Department of Transportation (NCDOT) contracts and to all related subcontracts, material supply, engineering, architectural and other service contracts, regardless of dollar amount. Any Federal provision that is specifically required not specifically set forth is hereby incorporated by reference.

(1) Title VI Assurances (USDOT Order 1050.2A, Appendix A)

During the performance of this contract, the contractor, for itself, its assignees, and successors in interest (hereinafter referred to as the "contractor") agrees as follows:

(a) Compliance with Regulations

The contractor (hereinafter includes consultants) shall comply with the Acts and the Regulations relative to Nondiscrimination in Federally-assisted programs of the U.S. Department of Transportation, Federal Highway Administration (FHWA), as they may be amended from time to time, which are herein incorporated by reference and made a part of this contract.

(b) Nondiscrimination

The contractor, with regard to the work performed by it during the contract, shall not discriminate on the grounds of race, color, or national origin in the selection and retention of subcontractors, including procurements of materials and leases of equipment. The contractor shall not participate directly or indirectly in the discrimination prohibited by the Acts and the Regulations, including employment practices when the contract covers any activity, project, or program set forth in Appendix B of 49 CFR Part 21.

(c) Solicitations for Subcontractors, Including Procurements of Materials and Equipment

In all solicitations, either by competitive bidding, or negotiation made by the contractor for work to be performed under a subcontract, including procurements of materials, or leases of equipment, each potential subcontractor or supplier shall be notified by the contractor of the contractor's obligations under this contract and the Acts and the Regulations relative to Nondiscrimination on the grounds of race, color, or national origin.

(d) Information and Reports

The contractor shall provide all information and reports required by the Acts, the Regulations, and directives issued pursuant thereto and shall permit access to its

books, records, accounts, other sources of information, and its facilities as may be determined by the Recipient or the FHWA to be pertinent to ascertain compliance with such Acts, Regulations, and instructions. Where any information required of a contractor is in the exclusive possession of another who fails or refuses to furnish the information, the contractor shall so certify to the Recipient or the FHWA, as appropriate, and shall set forth what efforts it has made to obtain the information.

(e) Sanctions for Noncompliance:

In the event of a contractor's noncompliance with the Non-discrimination provisions of this contract, the Recipient will impose such contract sanctions as it and/or the FHWA may determine to be appropriate, including, but not limited to:

- (i) Withholding payments to the contractor under the contract until the contractor complies; and/or
- (ii) Cancelling, terminating, or suspending a contract, in whole or in part.

(f) Incorporation of Provisions

The contractor shall include the provisions of paragraphs (a) through (f) in every subcontract, including procurements of materials and leases of equipment, unless exempt by the Acts, the Regulations and directives issued pursuant thereto. The contractor shall take action with respect to any subcontract or procurement as the Recipient or the FHWA may direct as a means of enforcing such provisions including sanctions for noncompliance. Provided, that if the contractor becomes involved in, or is threatened with litigation by a subcontractor, or supplier because of such direction, the contractor may request the Recipient to enter into any litigation to protect the interests of the Recipient. In addition, the contractor may request the United States to enter into the litigation to protect the interests of the United States.

(2) Title VI Nondiscrimination Program (23 CFR 200.5(p))

The North Carolina Department of Transportation (NCDOT) has assured the USDOT that, as a condition to receiving federal financial assistance, NCDOT will comply with Title VI of the Civil Rights Act of 1964 and all requirements imposed by Title 49 CFR part 21 and related nondiscrimination authorities to ensure that no person shall, on the ground of race, color, national origin, limited English proficiency, sex, age, or disability (including religion/creed or income-level, where applicable), be excluded from participation in, be denied the benefits of, or be subjected to discrimination under any programs, activities, or services conducted or funded by NCDOT. Contractors and other organizations under contract or agreement with NCDOT must also comply with Title VI and related authorities, therefore:

- (a) During the performance of this contract or agreement, contractors (e.g., subcontractors, consultants, vendors, prime contractors) are responsible for complying with NCDOT's Title VI Program. Contractors are not required to prepare or submit Title VI Programs. To comply with this section, the prime contractor shall:
 1. Post NCDOT's Notice of Nondiscrimination and the Contractor's own Equal Employment Opportunity (EEO) Policy in conspicuous locations accessible to all employees, applicants and subcontractors on the jobsite.

2. Physically incorporate the required Title VI clauses into all subcontracts on federally-assisted and state-funded NCDOT projects, and ensure inclusion by subcontractors into all lower-tier subcontracts.
 3. Required Solicitation Language. The Contractor shall include the following notification in all solicitations for bids and requests for work or material, regardless of funding source:

“The North Carolina Department of Transportation, in accordance with the provisions of Title VI of the Civil Rights Act of 1964 (78 Stat. 252, 42 U.S.C. §§ 2000d to 2000d-4) and the Regulations, hereby notifies all bidders that it will affirmatively ensure that any contract entered into pursuant to this advertisement, disadvantaged business enterprises will be afforded full and fair opportunity to submit bids in response to this invitation and will not be discriminated against on the grounds of race, color, or national origin in consideration for an award. In accordance with other related nondiscrimination authorities, bidders and contractors will also not be discriminated against on the grounds of sex, age, disability, low-income level, creed/religion, or limited English proficiency in consideration for an award.”
 4. Physically incorporate the FHWA-1273, in its entirety, into all subcontracts and subsequent lower tier subcontracts on Federal-aid highway construction contracts only.
 5. Provide language assistance services (i.e., written translation and oral interpretation), free of charge, to LEP employees and applicants. Contact NCDOT OCR for further assistance, if needed.
 6. For assistance with these Title VI requirements, contact the NCDOT Title VI Nondiscrimination Program at 1-800-522-0453.
- (b) Subrecipients (e.g. cities, counties, LGAs, planning organizations) may be required to prepare and submit a Title VI Plan to NCDOT, including Title VI Assurances and/or agreements. Subrecipients must also ensure compliance by their contractors and subrecipients with Title VI. (23 CFR 200.9(b)(7))
- (c) If reviewed or investigated by NCDOT, the contractor or subrecipient agrees to take affirmative action to correct any deficiencies found within a reasonable time period, not to exceed 90 calendar days, unless additional time is granted by NCDOT. (23 CFR 200.9(b)(15))
- (d) The Contractor is responsible for notifying subcontractors of NCDOT’s External Discrimination Complaints Process.
1. Applicability

Title VI and related laws protect participants and beneficiaries (e.g., members of the public and contractors) from discrimination by NCDOT employees, subrecipients and contractors, regardless of funding source.

2. Eligibility

Any person—or class of persons—who believes he/she has been subjected to discrimination based on race, color, national origin, Limited English Proficiency (LEP), sex, age, or disability (and religion in the context of employment, aviation, or transit) may file a written complaint. The law also prohibits intimidation or retaliation of any sort.

3. Time Limits and Filing Options

Complaints may be filed by the affected individual(s) or a representative and must be filed no later than 180 calendar days after the following:

- (i) The date of the alleged act of discrimination; or
- (ii) The date when the person(s) became aware of the alleged discrimination; or
- (iii) Where there has been a continuing course of conduct, the date on which that conduct was discontinued or the latest instance of the conduct.

Title VI and related discrimination complaints may be submitted to the following entities:

- North Carolina Department of Transportation, Office of Civil Rights, Title VI Program, 1511 Mail Service Center, Raleigh, NC 27699-1511; toll free 1-800-522-0453
- Federal Highway Administration, North Carolina Division Office, 310 New Bern Avenue, Suite 410, Raleigh, NC 27601, 919-747-7010
- US Department of Transportation, Departmental Office of Civil Rights, External Civil Rights Programs Division, 1200 New Jersey Avenue, SE, Washington, DC 20590; 202-366-4070

4. Format for Complaints

Complaints must be in writing and signed by the complainant(s) or a representative, and include the complainant's name, address, and telephone number. Complaints received by fax or e-mail will be acknowledged and processed. Allegations received by telephone will be reduced to writing and provided to the complainant for confirmation or revision before processing. Complaints will be accepted in other languages, including Braille.

5. Discrimination Complaint Form

Contact NCDOT Civil Rights to receive a full copy of the Discrimination Complaint Form and procedures.

6. Complaint Basis

Allegations must be based on issues involving race, color, national origin (LEP), sex, age, disability, or religion (in the context of employment, aviation or transit). "Basis" refers to the complainant's membership in a protected group category.

TABLE 103-1 COMPLAINT BASIS			
Protected Categories	Definition	Examples	Applicable Nondiscrimination Authorities
Race and Ethnicity	An individual belonging to one of the accepted racial groups; or the perception, based usually on physical characteristics that a person is a member of a racial group	Black/African American, Hispanic/Latino, Asian, American Indian/Alaska Native, Native Hawaiian/Pacific Islander, White	Title VI of the Civil Rights Act of 1964; 49 CFR Part 21; 23 CFR 200; 49 U.S.C. 5332(b); 49 U.S.C. 47123. (<i>Executive Order 13166</i>)
Color	Color of skin, including shade of skin within a racial group	Black, White, brown, yellow, etc.	
National Origin (<i>Limited English Proficiency</i>)	Place of birth. Citizenship is not a factor. (<i>Discrimination based on language or a person's accent is also covered</i>)	Mexican, Cuban, Japanese, Vietnamese, Chinese	
Sex	Gender. The sex of an individual. <i>Note: Sex under this program does not include sexual orientation.</i>	Women and Men	1973 Federal-Aid Highway Act; 49 U.S.C. 5332(b); 49 U.S.C. 47123.
Age	Persons of any age	21-year-old person	Age Discrimination Act of 1975 49 U.S.C. 5332(b); 49 U.S.C. 47123.
Disability	Physical or mental impairment, permanent or temporary, or perceived.	Blind, alcoholic, para-amputee, epileptic, diabetic, arthritic	Section 504 of the Rehabilitation Act of 1973; Americans with Disabilities Act of 1990
Religion (in the context of employment) (<i>Religion/ Creed in all aspects of any aviation or transit-related construction</i>)	An individual belonging to a religious group; or the perception, based on distinguishable characteristics that a person is a member of a religious group. In practice, actions taken as a result of the moral and ethical beliefs as to what is right and wrong, which are sincerely held with the strength of traditional religious views. <i>Note: Does not have to be associated with a recognized religious group or church; if an individual sincerely holds to the belief, it is a protected religious practice.</i>	Muslim, Christian, Sikh, Hindu, etc.	Title VII of the Civil Rights Act of 1964; 23 CFR 230; FHWA-1273 Required Contract Provisions. (<i>49 U.S.C. 5332(b); 49 U.S.C. 47123</i>)

(3) Pertinent Nondiscrimination Authorities

During the performance of this contract, the contractor, for itself, its assignees, and successors in interest agrees to comply with the following non-discrimination statutes and authorities, including, but not limited to:

- (a) Title VI of the Civil Rights Act of 1964 (42 U.S.C. § 2000d et seq., 78 stat. 252), (prohibits discrimination on the basis of race, color, national origin); and 49 CFR Part 21.

- (b) The Uniform Relocation Assistance and Real Property Acquisition Policies Act of 1970, (42 U.S.C. § 4601), (prohibits unfair treatment of persons displaced or whose property has been acquired because of Federal or Federal-aid programs and projects);
- (c) Federal-Aid Highway Act of 1973, (23 U.S.C. § 324 et seq.), (prohibits discrimination on the basis of sex);
- (d) Section 504 of the Rehabilitation Act of 1973, (29 U.S.C. § 794 et seq.), as amended, (prohibits discrimination on the basis of disability) and 49 CFR Part 27;
- (e) The Age Discrimination Act of 1975, as amended, (42 U.S.C. § 6101 et seq.), (prohibits discrimination on the basis of age);
- (f) Airport and Airway Improvement Act of 1982, (49 USC § 471, Section 47123), as amended, (prohibits discrimination based on race, creed, color, national origin, or sex);
- (g) The Civil Rights Restoration Act of 1987, (PL 100-209), (Broadened the scope, coverage and applicability of Title VI of the Civil Rights Act of 1964, The Age Discrimination Act of 1975 and Section 504 of the Rehabilitation Act of 1973, by expanding the definition of the terms "programs or activities" to include all of the programs or activities of the Federal-aid recipients, sub-recipients and contractors, whether such programs or activities are Federally funded or not);
- (h) Titles II and III of the Americans with Disabilities Act, which prohibit discrimination on the basis of disability in the operation of public entities, public and private transportation systems, places of public accommodation, and certain testing entities (42 U.S.C. §§ 12131-12189) as implemented by Department of Transportation regulations at 49 C.F.R. parts 37 and 38;
- (i) The Federal Aviation Administration's Nondiscrimination statute (49 U.S.C. § 47123) (prohibits discrimination on the basis of race, color, national origin, and sex);
- (j) Executive Order 12898, Federal Actions to Address Environmental Justice in Minority Populations and Low-Income Populations, which ensures Nondiscrimination against minority populations by discouraging programs, policies, and activities with disproportionately high and adverse human health or environmental effects on minority and low-income populations;
- (k) Executive Order 13166, Improving Access to Services for Persons with Limited English Proficiency, and resulting agency guidance, national origin discrimination includes discrimination because of Limited English proficiency (LEP). To ensure compliance with Title VI, you must take reasonable steps to ensure that LEP persons have meaningful access to your programs (70 Fed. Reg. at 74087 to 74100);
- (l) Title IX of the Education Amendments of 1972, as amended, which prohibits you from discriminating because of sex in education programs or activities (20 U.S.C. 1681 et seq).
- (m) Title VII of the Civil Rights Act of 1964 (42 U.S.C. § 2000e et seq., Pub. L. 88-352), (prohibits employment discrimination on the basis of race, color, religion, sex, or national origin).

(4) Additional Title VI Assurances

***The following Title VI Assurances (Appendices B, C and D) shall apply, as applicable*

- (a) Clauses for Deeds Transferring United States Property (1050.2A, Appendix B)

The following clauses will be included in deeds effecting or recording the transfer of real property, structures, or improvements thereon, or granting interest therein from the United States pursuant to the provisions of Assurance 4.

NOW, THEREFORE, the U.S. Department of Transportation as authorized by law and upon the condition that the North Carolina Department of Transportation (NCDOT) will accept title to the lands and maintain the project constructed thereon in accordance with the North Carolina General Assembly, the Regulations for the Administration of the Federal-Aid Highway Program, and the policies and procedures prescribed by the Federal Highway Administration of the U.S. Department of Transportation in accordance and in compliance with all requirements imposed by Title 49, Code of Federal Regulations, U.S. Department of Transportation, Subtitle A, Office of the Secretary, Part 21, Nondiscrimination in Federally-assisted programs of the U.S. Department of Transportation pertaining to and effectuating the provisions of Title VI of the Civil Rights Act of 1964 (78 Stat. 252; 42 U.S.C. § 2000d to 2000d-4), does hereby remise, release, quitclaim and convey unto the NCDOT all the right, title and interest of the U.S. Department of Transportation in and to said lands described in Exhibit A attached hereto and made a part hereof.

(HABENDUM CLAUSE)

TO HAVE AND TO HOLD said lands and interests therein unto the North Carolina Department of Transportation (NCDOT) and its successors forever, subject, however, to the covenants, conditions, restrictions and reservations herein contained as follows, which will remain in effect for the period during which the real property or structures are used for a purpose for which Federal financial assistance is extended or for another purpose involving the provision of similar services or benefits and will be binding on the NCDOT, its successors and assigns.

The NCDOT, in consideration of the conveyance of said lands and interests in lands, does hereby covenant and agree as a covenant running with the land for itself, its successors and assigns, that (1) no person will on the grounds of race, color, or national origin, be excluded from participation in, be denied the benefits of, or be otherwise subjected to discrimination with regard to any facility located wholly or in part on, over, or under such lands hereby conveyed [,] [and]* (2) that the NCDOT will use the lands and interests in lands and interests in lands so conveyed, in compliance with all requirements imposed by or pursuant to Title 49, Code of Federal Regulations, U.S. Department of Transportation, Subtitle A, Office of the Secretary, Part 21, Non-discrimination in Federally-assisted programs of the U.S. Department of Transportation, Effectuation of Title VI of the Civil Rights Act of 1964, and as said Regulations and Acts may be amended [, and (3) that in the event of breach of any of the above-mentioned nondiscrimination conditions, the Department will have a right to enter or re-enter said lands and facilities on said land, and that above described land and facilities will thereon revert to and vest in and become the absolute property of the U.S. Department of Transportation and its assigns as such interest existed prior to this instruction].*

(*Reverter clause and related language to be used only when it is determined that such a clause is necessary in order to make clear the purpose of Title VI.)

(b) Clauses for Transfer of Real Property Acquired or Improved Under the Activity, Facility, or Program (1050.2A, Appendix C)

The following clauses will be included in deeds, licenses, leases, permits, or similar instruments entered into by the North Carolina Department of Transportation (NCDOT) pursuant to the provisions of Assurance 7(a):

1. The (grantee, lessee, permittee, etc. as appropriate) for himself/herself, his/her heirs, personal representatives, successors in interest, and assigns, as a part of the consideration hereof, does hereby covenant and agree [in the case of deeds and leases add "as a covenant running with the land"] that:
 - (i.) In the event facilities are constructed, maintained, or otherwise operated on the property described in this (deed, license, lease, permit, etc.) for a purpose for which a U.S. Department of Transportation activity, facility, or program is extended or for another purpose involving the provision of similar services or benefits, the (grantee, licensee, lessee, permittee, etc.) will maintain and operate such facilities and services in compliance with all requirements imposed by the Acts and Regulations (as may be amended) such that no person on the grounds of race, color, or national origin, will be excluded from participation in, denied the benefits of, or be otherwise subjected to discrimination in the use of said facilities.
2. With respect to licenses, leases, permits, etc., in the event of breach of any of the above Nondiscrimination covenants, the NCDOT will have the right to terminate the (lease, license, permit, etc.) and to enter, re-enter, and repossess said lands and facilities thereon, and hold the same as if the (lease, license, permit, etc.) had never been made or issued. *
3. With respect to a deed, in the event of breach of any of the above Nondiscrimination covenants, the NCDOT will have the right to enter or re-enter the lands and facilities thereon, and the above described lands and facilities will there upon revert to and vest in and become the absolute property of the NCDOT and its assigns. *

(*Reverter clause and related language to be used only when it is determined that such a clause is necessary to make clear the purpose of Title VI.)

(c) Clauses for Construction/Use/Access to Real Property Acquired Under the Activity, Facility or Program (1050.2A, Appendix D)

The following clauses will be included in deeds, licenses, permits, or similar instruments/ agreements entered into by the North Carolina Department of Transportation (NCDOT) pursuant to the provisions of Assurance 7(b):

1. The (grantee, licensee, permittee, etc., as appropriate) for himself/herself, his/her heirs, personal representatives, successors in interest, and assigns, as a part of the consideration hereof, does hereby covenant and agree (in the case of deeds and leases add, "as a covenant running with the land") that (1) no person on the ground of race, color, or national origin, will be excluded from participation in, denied the benefits of, or be otherwise subjected to discrimination in the use of said facilities, (2) that in the construction of any improvements on, over, or under such land, and the furnishing of services thereon, no person on the ground of race, color, or national origin, will be excluded from participation in, denied the benefits of, or otherwise be subjected to discrimination, (3) that the (grantee, licensee, lessee, permittee, etc.) will use the premises in compliance with all other requirements imposed by or pursuant to the Acts and Regulations, as amended, set forth in this Assurance.
2. With respect to (licenses, leases, permits, etc.), in the event of breach of any of the above Non- discrimination covenants, the NCDOT will have the right to terminate the (license, permit, etc., as appropriate) and to enter or re-enter and repossess said land and the facilities thereon, and hold the same as if said (license, permit, etc., as appropriate) had never been made or issued. *
3. With respect to deeds, in the event of breach of any of the above Nondiscrimination covenants, the NCDOT will there upon revert to and vest in and become the absolute property of the NCDOT and its assigns. *

(*Reverter clause and related language to be used only when it is determined that such a clause is necessary to make clear the purpose of Title VI.)

STANDARD SPECIAL PROVISION**ON-THE-JOB TRAINING**

(10-16-07) (Rev. 4-21-15)

Z-10

Description

The North Carolina Department of Transportation will administer a custom version of the Federal On-the-Job Training (OJT) Program, commonly referred to as the Alternate OJT Program. All contractors (existing and newcomers) will be automatically placed in the Alternate Program. Standard OJT requirements typically associated with individual projects will no longer be applied at the project level. Instead, these requirements will be applicable on an annual basis for each contractor administered by the OJT Program Manager.

On the Job Training shall meet the requirements of 23 CFR 230.107 (b), 23 USC – Section 140, this provision and the On-the-Job Training Program Manual.

The Alternate OJT Program will allow a contractor to train employees on Federal, State and privately funded projects located in North Carolina. However, priority shall be given to training employees on NCDOT Federal-Aid funded projects.

Minorities and Women

Developing, training and upgrading of minorities and women toward journeyman level status is a primary objective of this special training provision. Accordingly, the Contractor shall make every effort to enroll minority and women as trainees to the extent that such persons are available within a reasonable area of recruitment. This training commitment is not intended, and shall not be used, to discriminate against any applicant for training, whether a member of a minority group or not.

Assigning Training Goals

The Department, through the OJT Program Manager, will assign training goals for a calendar year based on the contractors' past three years' activity and the contractors' anticipated upcoming year's activity with the Department. At the beginning of each year, all contractors eligible will be contacted by the Department to determine the number of trainees that will be assigned for the upcoming calendar year. At that time the Contractor shall enter into an agreement with the Department to provide a self-imposed on-the-job training program for the calendar year. This agreement will include a specific number of annual training goals agreed to by both parties. The number of training assignments may range from 1 to 15 per contractor per calendar year. The Contractor shall sign an agreement to fulfill their annual goal for the year.\

Training Classifications

The Contractor shall provide on-the-job training aimed at developing full journeyman level workers in the construction craft/operator positions. Preference shall be given to providing training in the following skilled work classifications:

Equipment Operators	Office Engineers
Truck Drivers	Estimators
Carpenters	Iron / Reinforcing Steel Workers
Concrete Finishers	Mechanics
Pipe Layers	Welders

The Department has established common training classifications and their respective training requirements that may be used by the contractors. However, the classifications established are not all-inclusive. Where the training is oriented toward construction applications, training will be allowed in lower-level management positions such as office engineers and estimators. Contractors shall submit new classifications for specific job functions that their employees are performing. The Department will review and recommend for acceptance to FHWA the new classifications proposed by contractors, if applicable. New classifications shall meet the following requirements:

Proposed training classifications are reasonable and realistic based on the job skill classification needs, and

The number of training hours specified in the training classification is consistent with common practices and provides enough time for the trainee to obtain journeyman level status.

The Contractor may allow trainees to be trained by a subcontractor provided that the Contractor retains primary responsibility for meeting the training and this provision is made applicable to the subcontract. However, only the Contractor will receive credit towards the annual goal for the trainee.

Where feasible, 25 percent of apprentices or trainees in each occupation shall be in their first year of apprenticeship or training. The number of trainees shall be distributed among the work classifications on the basis of the contractor's needs and the availability of journeymen in the various classifications within a reasonable area of recruitment.

No employee shall be employed as a trainee in any classification in which they have successfully completed a training course leading to journeyman level status or in which they have been employed as a journeyman.

Records and Reports

The Contractor shall maintain enrollment, monthly and completion reports documenting company compliance under these contract documents. These documents and any other information as requested shall be submitted to the OJT Program Manager.

Upon completion and graduation of the program, the Contractor shall provide each trainee with a certification Certificate showing the type and length of training satisfactorily completed.

Trainee Interviews

All trainees enrolled in the program will receive an initial and Trainee/Post graduate interview conducted by the OJT program staff.

Trainee Wages

Contractors shall compensate trainees on a graduating pay scale based upon a percentage of the prevailing minimum journeyman wages (Davis-Bacon Act). Minimum pay shall be as follows:

60 percent	of the journeyman wage for the first half of the training period
75 percent	of the journeyman wage for the third quarter of the training period
90 percent	of the journeyman wage for the last quarter of the training period

In no instance shall a trainee be paid less than the local minimum wage. The Contractor shall adhere to the minimum hourly wage rate that will satisfy both the NC Department of Labor (NCDOL) and the Department.

Achieving or Failing to Meet Training Goals

The Contractor will be credited for each trainee employed by him on the contract work who is currently enrolled or becomes enrolled in an approved program and who receives training for at least 50 percent of the specific program requirement. Trainees will be allowed to be transferred between projects if required by the Contractor's scheduled workload to meet training goals.

If a contractor fails to attain their training assignments for the calendar year, they may be taken off the NCDOT's Bidders List.

Measurement and Payment

No compensation will be made for providing required training in accordance with these contract documents.



DocuSigned by:
Renee B. Roach, PE
 3EB4360BD316431...
 9-17-24

YIELD LINES PAVEMENT MARKING:

(1-15-24)(Rev. 9-17-24)

Description

Install yield lines in accordance with this special provision, Section 1205 of the *Standard Specifications* and as directed by the Engineer.

Materials

Refer to Division 10 of the *Standard Specifications*.

Item	Section
Pavement Markings	1087

The material for yield line pavement markings shall be thermoplastic, polyurea, type III cold applied plastic, or heated-in-place thermoplastic. Paint may be used for temporary yield line pavement markings.

Application

Refer to Section 1205 of the *Standard Specifications* and refer to Division 12 of the *Roadway Standard Drawings* on application of products used for yield lines. Yield lines shall be a row of solid white isosceles triangles with 3 to 12 inches between each one, 12 to 24 inches in width, with a height 1.5 times the width. Yield lines shall point towards traffic, and they shall be placed at least 4 feet before the nearest controlled crosswalk. For unsignalized midblock crosswalks, yield lines shall be placed with the Yield Here to Pedestrians sign located 20 to 50 feet in advance of the crosswalk. Yield lines are not symbols or characters.

Measurement and Payment

Yield Line _____ Pavement Marking, __", *__mils* (for thermoplastic, polyurea and heated-in-place thermoplastic material), *Yield Line Pavement Marking, Type III (__"*) (for Type 3 cold applied plastic material), or *Yield Line Pavement Marking, __"* (for paint material) will be measured and paid as the actual number of linear feet of pavement marking lines satisfactorily

placed and accepted by the Engineer. The quantity of lines will be the summation of the linear feet of solid line measured end-to-end of the line.

Payment will be made under:

Pay Item	Pay Unit
Yield Line _____ Pavement Marking, __", __mils	Linear Feet
Yield Line Cold Applied Plastic Pavement Marking, Type III (___")	Linear Feet
Yield Line Paint Pavement Marking, ___"	Linear Feet

TC-1

U-4713A

Mecklenburg County

WORK ZONE TRAFFIC CONTROL Project Special Provisions Table of Contents

Special Provision	Page
ADA Compliant Pedestrian Traffic Control Devices	TC-2

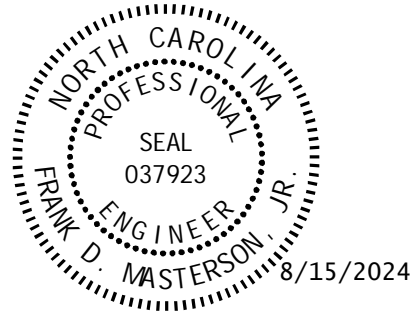

DocuSigned by:
Frank Masterson
60FB2BD6CFF1412...

TC-2

U-4713A

Mecklenburg County

ADA COMPLIANT PEDESTRIAN TRAFFIC CONTROL DEVICES:

(10/31/2017) (Rev. 6/3/2022)

Description

Furnish, install, and maintain all ADA compliant pedestrian traffic control devices for existing pedestrian facilities that are disrupted, closed, or relocated by planned work activities.

The ADA compliant pedestrian traffic control devices used to either close, redirect, divert or detour pedestrian traffic are Pedestrian Channelizing Devices, Audible Warning Devices and Temporary Curb Ramps.

Construction Methods

The ADA compliant pedestrian traffic control devices involved in the closing or redirecting of pedestrians as designated on the Transportation Management Plan (TMP) shall be manufactured and assembled in accordance with the requirements of the Americans with Disabilities Act (ADA) and be on the NCDOT approved products list.

Pedestrian Channelizing Devices shall be manufactured and assembled to be connected as to eliminate any gaps that allow pedestrians to stray from the channelizing path. Any Pedestrian Channelizing Devices used to close or block a pedestrian facility shall have a "SIDEWALK CLOSED" sign affixed to it and any audible warning devices, if designated on the TMP.

Audible Warning Devices shall be manufactured to include a locator tone activated by a motion sensor and have the ability to program a message for a duration of at least 1 minute. The motion sensor shall have the ability to detect pedestrians a minimum of 10' away. The voice module may be automatic or it may be push button activated. If push button activated, it shall be mounted at a height of approximately 3.5 feet, but no more than 4 feet, above the pedestrian facility.

Temporary Curb Ramps shall be manufactured and assembled to meet all of the requirements for persons with walking disabilities, including wheelchair confinement, according to the ADA regulations. All detectable warning features are to be included with these installations.

Measurement and Payment

Pedestrian Channelizing Devices will be measured and paid as the maximum number of linear feet of *Pedestrian Channelizing Devices* furnished, acceptably placed, and in use at any one time during the life of the project.

TC-3

U-4713A

Mecklenburg County

No direct payment will be made for any sign affixed to a pedestrian channelizing device. Signs mounted to pedestrian channelizing devices will be considered incidental to the device.

Audible Warning Devices will be measured and paid as the maximum number of *Audible Warning Devices* furnished, acceptably installed, and in use at any one time during the life of the project.

Relocation, replacement, repair, maintenance, or disposal of *Pedestrian Channelizing Devices* and *Audible Warning Devices* will be incidental to the pay item.

Temporary Curb Ramps will be measured and paid as the actual number of *Temporary Curb Ramps* furnished, acceptably installed, and in use. *Temporary Curb Ramps* will be paid for each time a curb ramp is moved from one location on the project to another location on the project.

Payment will be made under:

Pay Item	Pay Unit
Pedestrian Channelizing Devices	Linear Foot
Audible Warning Devices	Each
Temporary Curb Ramps	Each

Project: U-4713A

UC-1

County: Mecklenburg

PROJECT SPECIAL PROVISIONS
Utility Construction



License No. C-2639
10020 Monroe Rd.
Suite 280
Matthews, NC 28277
(704) 814-4407



**DOCUMENT NOT CONSIDERED FINAL
UNLESS ALL SIGNATURES COMPLETED**

Where brand names and model numbers are specified in these Special Provisions or in the plans, the cited examples are used only to denote the quality standard of product desired and do not restrict bidders to a specific brand, make, or manufacturer. They are provided to set forth the general style, type, character, and quality of the product desired. Equivalent products will be acceptable.

The utility owner is Charlotte Water (CLTWater). The CLTWater representative is Mr. Logan Hedrick; and he can be reached by phone at (980) 253-4390 or by email at Logan.Hedrick@charlottenc.gov. The contractor is required to contact Logan Hedrick at least two (2) weeks prior to the commencement of any water and/or sewer construction.

The provisions contained within these Utilities Construction Project Special Provisions modify the *Standard Specifications* only for materials used and work performed constructing water or sewer facilities owned by CLTWater.

Provide materials for the proposed water and sewer utilities construction meeting the applicable requirements (i.e. material specifications, standard details, testing, policies, etc.) of CLTWater’s standard specifications and applicable current CLTWater standard details as of Date of Advertisement. CLTWater specifications and details can be obtained from CLTWater at <https://www.charlottenc.gov/water/DevelopmentProjects/Design-Manual>.

Measurement and payment for work will be in accordance with the *NCDOT Standard Specifications for Roads and Structures*, January 2024.

Project: U-4713A

UC-2

County: Mecklenburg

COOPERATION WITH THE UTILITY OWNER
(9-5-23)

Revise the 2024 Standard Specifications as follows:

Page 15-1, Article 1500-2 COOPERATION WITH THE UTILITY OWNER, paragraph 2:
add the following sentences:

The contractor shall keep the appointed representative from CLTWater informed of the work progress and provide opportunity for inspection of construction and testing.

The contractor shall maintain water and sewer service to existing customers during construction, minimize the duration of any service disruption, and notify the CLTWater representative at least 48 hours in advance of any scheduled service disruption.

SUBMITTALS AND RECORDS
(9-5-23)

Revise the 2024 Standard Specifications as follows:

Page 15-2, Article 1500-7 SUBMITTALS AND RECORDS, paragraph 2, add the following sentences:

Prior to water and/or sewer construction, the contractor must submit to Logan Hedrick, the proposed utility material submittals and shop drawings, as applicable for CLTWater review and obtain CLTWater approval of utility material submittals and shop drawings.

PROJECT SPECIAL PROVISIONS

Utilities by Others



5430 Wade Park Blvd. Ste 106
Raleigh, NC 27607
919-929-1173
License# F-1267

General:

The following utility companies have facilities that will be in conflict with the construction of this project:

- A) Power - Duke Energy (Distribution)
- B) Gas – Duke Energy (Piedmont Natural Gas)
- C) CATV – Spectrum
- D) Fiber – MCNC
- E) Phone - Segra
- F) Phone – Windstream

The conflicting facilities of these concerns will be adjusted prior to the date of availability, unless otherwise noted and are therefore listed in these special provisions for the benefit of the Contractor. All utility work listed herein will be done by the utility owners. All utilities are shown on the plans from the best available information.

The Contractor’s attention is directed to Article 105-8 of the 2024 Standard Specifications.

Utilities Requiring Adjustment:

Utility relocations are shown on the Utilities by Others Plans.

- A) Duke Energy – POWER (Distribution)
 - 1) Duke will install new poles within the project limits and transfer power to them. Duke will have all relocations completed by 2/1/25.
 - 2) Contact person for Duke is Steve Ferrell, 704-395-4437, Steve.Ferrell2@duke-energy.com
- B) Duke Energy (Piedmont Natural Gas)– Natural Gas

PROJECT SPECIAL PROVISIONS

Utilities by Others

- 1) Piedmont will have all relocations within the project limits completed by 2/1/25.
 - 2) Contact person for PNG is Marcus Cuthbertson, 704-587-6944,
marcus.cuthbertson@duke-energy.com
- C) Spectrum - CATV
- 1) Spectrum is the owner of CATV facilities on the project. Spectrum will have all relocations within the project limits completed by 2/1/25.
 - 2) Contact person for Spectrum is Josh Auten, 704-378-2636,
Joshua.Auten@Charter.com
- CI) MCNC - FIBER
- 1) MCNC will relocate buried facilities along E. John Street by 2/1/25.
 - 2) Contact person for MCNC is Paul Shaw, 704-363-0021, Pshaw@MCNC.org
- CII) Segra - TELEPHONE
- 3) Segra will relocate buried facilities along E. John Street and McKee Road by 2/1/25.
 - 4) Contact person for Segra is Robert Robinson, 803-230-0515,
Robert.Robinson@Segra.com
- CIII) Windstream - TELEPHONE
- 1) Windstream will install aerial cables on Duke's poles by 2/1/25.
 - 2) Contact person for Windstream is Jonathan Lowe, 704-310-6040,
Jonathan.Lowe@Windstream.com

**Project Special Provisions
Erosion Control**

STABILIZATION REQUIREMENTS:

(4-30-2019)

Stabilization for this project shall comply with the time frame guidelines as specified by the NCG-010000 general construction permit issued by the North Carolina Department of Environmental Quality Division of Water Resources. Temporary or permanent ground cover stabilization shall occur within 7 calendar days from the last land-disturbing activity, with the following exceptions in which temporary or permanent ground cover shall be provided in 14 calendar days from the last land-disturbing activity:

- Slopes between 2:1 and 3:1, with a slope length of 10 ft. or less
- Slopes 3:1 or flatter, with a slope of length of 50 ft. or less
- Slopes 4:1 or flatter

The stabilization timeframe for High Quality Water (HQW) Zones shall be 7 calendar days with no exceptions for slope grades or lengths. High Quality Water Zones (HQW) Zones are defined by North Carolina Administrative Code 15A NCAC 04A.0105 (25). Temporary and permanent ground cover stabilization shall be achieved in accordance with the provisions in this contract and as directed.

SEEDING AND MULCHING:

(West)

The kinds of seed and fertilizer, and the rates of application of seed, fertilizer, and limestone, shall be as stated below. During periods of overlapping dates, the kind of seed to be used shall be determined. All rates are in pounds per acre.

Shoulder and Median Areas

August 1 - June 1

20#	Kentucky Bluegrass
75#	Hard Fescue
25#	Rye Grain
500#	Fertilizer
4000#	Limestone

May 1 - September 1

20#	Kentucky Bluegrass
75#	Hard Fescue
10#	German or Browntop Millet
500#	Fertilizer
4000#	Limestone

Areas Beyond the Mowing Pattern, Waste and Borrow Areas:

August 1 - June 1

100#	Tall Fescue
15#	Kentucky Bluegrass
30#	Hard Fescue
25#	Rye Grain
500#	Fertilizer

May 1 - September 1

100#	Tall Fescue
15#	Kentucky Bluegrass
30#	Hard Fescue
10#	German or Browntop Millet
500#	Fertilizer

4000# Limestone 4000# Limestone

Approved Tall Fescue Cultivars

06 Dust	Escalade	Justice	Serengeti
2 nd Millennium	Essential	Kalahari	Shelby
3 rd Millennium	Evergreen 2	Kitty Hawk 2000	Sheridan
Apache III	Falcon IV	Legitimate	Signia
Avenger	Falcon NG	Lexington	Silver Hawk
Barlexas	Falcon V	LSD	Sliverstar
Barlexas II	Faith	Magellan	Shenandoah Elite
Bar Fa	Fat Cat	Matador	Sidewinder
Barrera	Festnova	Millennium SRP	Skyline
Barrington	Fidelity	Monet	Solara
Barrobusto	Finelawn Elite	Mustang 4	Southern Choice II
Barvado	Finelawn Xpress	Ninja 2	Speedway
Biltmore	Finesse II	Ol' Glory	Spyder LS
Bingo	Firebird	Olympic Gold	Sunset Gold
Bizem	Firecracker LS	Padre	Taccoa
Blackwatch	Firenza	Patagonia	Tanzania
Blade Runner II	Five Point	Pedigree	Trio
Bonsai	Focus	Picasso	Tahoe II
Braveheart	Forte	Piedmont	Talladega
Bravo	Garrison	Plantation	Tarheel
Bullseye	Gazelle II	Proseeds 5301	Terrano
Cannavaro	Gold Medallion	Prospect	Titan ltd
Catalyst	Grande 3	Pure Gold	Titanium LS
Cayenne	Greenbrooks	Quest	Tracer
Cessane Rz	Greenkeeper	Raptor II	Traverse SRP
Chipper	Gremlin	Rebel Exeda	Tulsa Time
Cochise IV	Greystone	Rebel Sentry	Turbo
Constitution	Guardian 21	Rebel IV	Turbo RZ
Corgi	Guardian 41	Regiment II	Tuxedo RZ
Corona	Hemi	Regenerate	Ultimate
Coyote	Honky Tonk	Rendition	Venture
Darlington	Hot Rod	Rhambler 2 SRP	Umbrella
Davinci	Hunter	Rembrandt	Van Gogh
Desire	Inferno	Reunion	Watchdog
Dominion	Innovator	Riverside	Wolfpack II
Dynamic	Integrity	RNP	Xtremegreen
Dynasty	Jaguar 3	Rocket	
Endeavor	Jamboree	Scorpion	

Approved Kentucky Bluegrass Cultivars:

4-Season	Blue Velvet	Gladstone	Quantum Leap
Alexa II	Blueberry	Granite	Rambo
America	Boomerang	Hampton	Rhapsody
Apollo	Brilliant	Harmonie	Rhythm
Arcadia	Cabernet	Impact	Rita
Aries	Champagne	Jefferson	Royce
Armada	Champlain	Juliet	Rubicon
Arrow	Chicago II	Jump Start	Rugby II
Arrowhead	Corsair	Keeneland	Shiraz
Aura	Courtyard	Langara	Showcase
Avid	Delight	Liberator	Skye
Award	Diva	Madison	Solar Eclipse
Awesome	Dynamo	Mercury	Sonoma
Bandera	Eagleton	Midnight	Sorbonne
Barduke	Emblem	Midnight II	Starburst
Barnique	Empire	Moon Shadow	Sudden Impact
Baroness	Envicta	Moonlight SLT	Total Eclipse
Barrister	Everest	Mystere	Touche
Barvette HGT	Everglade	Nu Destiny	Tsunami
Bedazzled	Excursion	NuChicago	Unique
Belissimo	Freedom II	NuGlade	Valor
Bewitched	Freedom III	Odyssey	Voyager II
Beyond	Front Page	Perfection	Washington
Blacksburg II	Futurity	Pinot	Zinfandel
Blackstone	Gaelic	Princeton 105	
Blue Note	Ginney II	Prosperity	

Approved Hard Fescue Cultivars:

Aurora II	Eureka II	Oxford	Scaldis II
Aurora Gold	Firefly	Reliant II	Spartan II
Berkshire	Granite	Reliant IV	Stonehenge
Bighorn GT	Heron	Rescue 911	
Chariot	Nordic	Rhino	

On cut and fill slopes 2:1 or steeper add 20# Sericea Lespedeza January 1 - December 31.

Fertilizer shall be 10-20-20 analysis. A different analysis of fertilizer may be used provided the 1-2-2 ratio is maintained and the rate of application adjusted to provide the same amount of plant food as a 10-20-20 analysis and as directed.

Native Grass Seeding And Mulching

(West)

Native Grass Seeding and Mulching shall be performed on the disturbed areas of wetlands and riparian areas, and adjacent to Stream Relocation and/or trout stream construction within a 50 foot zone on both sides of the stream or depression, measured from top of stream bank or center of

depression. The stream bank of the stream relocation shall be seeded by a method that does not alter the typical cross section of the stream bank. Native Grass Seeding and Mulching shall also be performed in the permanent soil reinforcement mat section of preformed scour holes, and in other areas as directed.

The kinds of seed and fertilizer, and the rates of application of seed, fertilizer, and limestone, shall be as stated below. During periods of overlapping dates, the kind of seed to be used shall be determined. All rates are in pounds per acre.

August 1 - June 1		May 1 – September 1	
18#	Creeping Red Fescue	18#	Creeping Red Fescue
8#	Big Bluestem	8#	Big Bluestem
6#	Indiangrass	6#	Indiangrass
4#	Switchgrass	4#	Switchgrass
35#	Rye Grain	25#	German or Browntop Millet
500#	Fertilizer	500#	Fertilizer
4000#	Limestone	4000#	Limestone

Approved Creeping Red Fescue Cultivars:

Aberdeen Boreal Epic Cindy Lou

Fertilizer shall be 10-20-20 analysis. A different analysis of fertilizer may be used provided the 1-2-2 ratio is maintained and the rate of application adjusted to provide the same amount of plant food as a 10-20-20 analysis and as directed.

Native Grass Seeding and Mulching shall be performed in accordance with Section 1660 of the *Standard Specifications* and vegetative cover sufficient to restrain erosion shall be installed immediately following grade establishment.

Measurement and Payment

Native Grass *Seeding and Mulching* will be measured and paid for in accordance with Article 1660-8 of the *Standard Specifications*.

TEMPORARY SEEDING:

Fertilizer shall be the same analysis as specified for *Seeding and Mulching* and applied at the rate of 400 pounds and seeded at the rate of 50 pounds per acre. German Millet, or Browntop Millet shall be used in summer months and rye grain during the remainder of the year. The Engineer will determine the exact dates for using each kind of seed.

FERTILIZER TOPDRESSING:

Fertilizer used for topdressing shall be 16-8-8 grade and shall be applied at the rate of 500 pounds per acre. A different analysis of fertilizer may be used provided the 2-1-1 ratio is maintained and

the rate of application adjusted to provide the same amount of plant food as 16-8-8 analysis and as directed.

SUPPLEMENTAL SEEDING:

The kinds of seed and proportions shall be the same as specified for *Seeding and Mulching*, and the rate of application may vary from 25# to 75# per acre. The actual rate per acre will be determined prior to the time of topdressing and the Contractor will be notified in writing of the rate per acre, total quantity needed, and areas on which to apply the supplemental seed. Minimum tillage equipment, consisting of a sod seeder shall be used for incorporating seed into the soil as to prevent disturbance of existing vegetation. A clodbuster (ball and chain) may be used where degree of slope prevents the use of a sod seeder.

MOWING:

The minimum mowing height on this project shall be six inches.

LAWN TYPE APPEARANCE:

All areas adjacent to lawns must be hand finished as directed to give a lawn type appearance. Remove all trash, debris, and stones $\frac{3}{4}$ " and larger in diameter or other obstructions that could interfere with providing a smooth lawn type appearance. These areas shall be reseeded to match their original vegetative conditions, unless directed otherwise by the Field Operations Engineer.

MINIMIZE REMOVAL OF VEGETATION:

The Contractor shall minimize removal of vegetation within project limits to the maximum extent practicable. Vegetation along stream banks and adjacent to other jurisdictional resources outside the construction limits shall only be removed upon approval of Engineer. No additional payment will be made for this minimization work.

CONSTRUCTION MATERIALS MANAGEMENT

(3-19-19) (rev. 04-27-20)

Description

The requirements set forth shall be adhered to in order to meet the applicable materials handling requirements of the NCG010000 permit. Structural controls installed to manage construction materials stored or used on site shall be shown on the E&SC Plan. Requirements for handling materials on construction sites shall be as follows:

Polyacrylamides (PAMS) and Flocculants

Polyacrylamides (PAMS) and flocculants shall be stored in leak-proof containers that are kept under storm-resistant cover or surrounded by secondary containment structures designed to protect adjacent surface waters. PAMS or other flocculants used shall be selected from the NC DWR List

of Approved PAMS/Flocculants The concentration of PAMS and other flocculants used shall not exceed those specified in the NC DWR List of Approved PAMS/Flocculants and in accordance with the manufacturer's instructions. The NC DWR List of Approved PAMS/Flocculants is available at:

https://files.nc.gov/ncdeq/Water+Quality/Environmental+Sciences/ATU/PAM8_30_18.pdf

Equipment Fluids

Fuels, lubricants, coolants, and hydraulic fluids, and other petroleum products shall be handled and disposed of in a manner so as not to enter surface or ground waters and in accordance with applicable state and federal regulations. Equipment used on the site must be operated and maintained properly to prevent discharge of fluids. Equipment, vehicle, and other wash waters shall not be discharged into E&SC basins or other E&SC devices. Alternative controls should be provided such that there is no discharge of soaps, solvents, or detergents.

Waste Materials

Construction materials and land clearing waste shall be disposed of in accordance with North Carolina General Statutes, Chapter 130A, Article 9 - Solid Waste Management, and rules governing the disposal of solid waste (15A NCAC 13B). Areas dedicated for managing construction material and land clearing waste shall be at least 50 feet away from storm drain inlets and surface waters unless it can be shown that no other alternatives are reasonably available. Paint and other liquid construction material waste shall not be dumped into storm drains. Paint and other liquid construction waste washouts should be located at least 50 feet away from storm drain inlets unless there is no alternative. Other options are to install lined washouts or use portable, removable bags or bins. Hazardous or toxic waste shall be managed in accordance with the federal Resource Conservation and Recovery Act (RCRA) and NC Hazardous Waste Rules at 15A NCAC, Subchapter 13A. Litter and sanitary waste shall be managed in a manner to prevent it from entering jurisdictional waters and shall be disposed of offsite.

Herbicide, Pesticide, and Rodenticides

Herbicide, pesticide, and rodenticides shall be stored and applied in accordance with the Federal Insecticide, Fungicide, and Rodenticide Act, North Carolina Pesticide Law of 1971 and labeling restrictions.

Concrete Materials

Concrete materials onsite, including excess concrete, must be controlled and managed to avoid contact with surface waters, wetlands or buffers. No concrete or cement slurry shall be discharged from the site. (Note that discharges from onsite concrete plants require coverage under a separate NPDES permit – NCG140000.) Concrete wash water shall be managed in accordance with the *Concrete Washout Structure* provision. Concrete slurry shall be managed and disposed of in accordance with *NC DOT DGS and HOS DCAR Distribution of Class A Residuals Statewide*

(Permit No. WQ0035749). Any hardened concrete residue will be disposed of, or recycled on site, in accordance with state solid waste regulations.

Earthen Material Stock Piles

Earthen material stock piles shall be located at least 50 feet away from storm drain inlets and surface waters unless it can be shown that no other alternatives are reasonably available.

Measurement and Payment

Conditions set within the *Construction Materials Management* provision are incidental to the project for which no direct compensation will be made.

WASTE AND BORROW SOURCES:

(2-16-11) (Rev. 3-17-22)

Payment for temporary erosion control measures, except those made necessary by the Contractor's own negligence or for his own convenience, will be paid for at the appropriate contract unit price for the devices or measures utilized in borrow sources and waste areas.

No additional payment will be made for erosion control devices or permanent seeding and mulching in any commercial borrow or waste pit. All erosion and sediment control practices that may be required on a commercial borrow or waste site will be done at the Contractor's expense.

All offsite Staging Areas, Borrow and Waste sites shall be in accordance with "Borrow and Waste Site Reclamation Procedures for Contracted Projects" located at:

<https://connect.ncdot.gov/resources/roadside/FieldOperationsDocuments/Contract%20Reclamation%20Procedures.pdf>

All forms and documents referenced in the "Borrow and Waste Site Reclamation Procedures for Contracted Projects" shall be included with the reclamation plans for offsite staging areas, and borrow and waste sites.

TEMPORARY DIVERSION:

This work consists of installation, maintenance, and cleanout of *Temporary Diversions* in accordance with Section 1630 of the *Standard Specifications*. The quantity of excavation for installation and cleanout will be measured and paid for as *Silt Excavation* in accordance with Article 1630-3 of the *Standard Specifications*.

SAFETY FENCE AND JURISDICTIONAL FLAGGING:**Description**

Safety Fence shall consist of furnishing materials, installing and maintaining polyethylene or polypropylene fence along the outside riparian buffer, wetland, or water boundary, or other boundaries located within the construction corridor to mark the areas that have been approved to infringe within the buffer, wetland, endangered vegetation, culturally sensitive areas or water. The fence shall be installed prior to any land disturbing activities.

Interior boundaries for jurisdictional areas noted above shall be delineated by stakes and highly visible flagging.

Jurisdictional boundaries at staging areas, waste sites, or borrow pits, whether considered outside or interior boundaries shall be delineated by stakes and highly visible flagging.

Materials**(A) Safety Fencing**

Polyethylene or polypropylene fence shall be a highly visible preconstructed safety fence approved by the Engineer. The fence material shall have an ultraviolet coating.

Either wood posts or steel posts may be used. Wood posts shall be hardwood with a wedge or pencil tip at one end, and shall be at least 5 ft. in length with a minimum nominal 2" x 2" cross section. Steel posts shall be at least 5 ft. in length, and have a minimum weight of 0.85 lb/ft of length.

(B) Boundary Flagging

Wooden stakes shall be 4 feet in length with a minimum nominal 3/4" x 1-3/4" cross section. The flagging shall be at least 1" in width. The flagging material shall be vinyl and shall be orange in color and highly visible.

Construction Methods

No additional clearing and grubbing is anticipated for the installation of this fence. The fence shall be erected to conform to the general contour of the ground.

(A) Safety Fencing

Posts shall be set at a maximum spacing of 10 ft., maintained in a vertical position and hand set or set with a post driver. Posts shall be installed a minimum of 2 ft. into the ground. If hand set, all backfill material shall be thoroughly tamped. Wood posts may be sharpened to a dull point if power driven. Posts damaged by power driving shall be removed and replaced prior to final

acceptance. The tops of all wood posts shall be cut at a 30-degree angle. The wood posts may, at the option of the Contractor, be cut at this angle either before or after the posts are erected.

The fence geotextile shall be attached to the wood posts with one 2" galvanized wire staple across each cable or to the steel posts with wire or other acceptable means.

Place construction stakes to establish the location of the safety fence in accordance with Article 105-9 or Article 801-1 of the *Standard Specifications*. No direct pay will be made for the staking of the safety fence. All stakeouts for safety fence shall be considered incidental to the work being paid for as "Construction Surveying", except that where there is no pay item for construction surveying, all safety fence stakeout will be performed by state forces.

The Contractor shall be required to maintain the safety fence in a satisfactory condition for the duration of the project as determined by the Engineer.

(B) Boundary Flagging

Boundary flagging delineation of interior boundaries shall consist of wooden stakes on 25 feet maximum intervals with highly visible orange flagging attached. Stakes shall be installed a minimum of 6" into the ground. Interior boundaries may be staked on a tangent that runs parallel to buffer but must not encroach on the buffer at any location. Interior boundaries of hand clearing shall be identified with a different colored flagging to distinguish it from mechanized clearing.

Boundary flagging delineation of interior boundaries will be placed in accordance with Article 105-9 or Article 801-1 of the *Standard Specifications*. No direct pay will be made for delineation of the interior boundaries. This delineation will be considered incidental to the work being paid for as *Construction Surveying*, except that where there is no pay item or construction surveying the cost of boundary flagging delineation shall be included in the unit prices bid for the various items in the contract. Installation for delineation of all jurisdictional boundaries at staging areas, waste sites, or borrow pits shall consist of wooden stakes on 25 feet maximum intervals with highly visible orange flagging attached. Stakes shall be installed a minimum of 6" into the ground. Additional flagging may be placed on overhanging vegetation to enhance visibility but does not substitute for installation of stakes.

Installation of boundary flagging for delineation of all jurisdictional boundaries at staging areas, waste sites, or borrow pits shall be performed in accordance with Subarticle 230-4(B)(5) or Subarticle 802-2(F) of the *Standard Specifications*. No direct pay will be made for this delineation, as the cost of same shall be included in the unit prices bid for the various items in the contract.

The Contractor shall be required to maintain alternative stakes and highly visible flagging in a satisfactory condition for the duration of the project as determined by the Engineer.

Measurement and Payment

Safety Fence will be measured and paid as the actual number of linear feet of polyethylene or polypropylene fence installed in place and accepted. Such payment will be full compensation

including but not limited to furnishing and installing fence geotextile with necessary posts and post bracing, staples, tie wires, tools, equipment and incidentals necessary to complete this work.

Payment will be made under:

Pay Item	Pay Unit
Safety Fence	Linear Foot

PERMANENT SOIL REINFORCEMENT MAT:

9-1-2011 (Rev. 8-16-24)

Description

This work consists of furnishing and placing permanent soil reinforcement mat (PSRM), of the type specified, over previously prepared areas at locations shown on the plans and as directed by the Engineer.

Materials

The product shall be a permanent soil reinforcement mat constructed of synthetic stabilized, non-biodegradable synthetic fibers processed to form a rigid permanent three-dimensional structure to promote soil stability in combination with vegetation under hydraulic stresses. Organic biodegradable fibers (such as straw, coir, excelsior or blends thereof) may also be incorporated into the PSRM, evenly distributed throughout the mat. PSRMs utilizing organic fibers shall have a bottom and top UV stabilized netting stitched together with UV stabilized thread to retain the organic fibers. All PSRMs shall meet the following minimum physical properties:

Property	Test Method	Value	Unit
Thickness	ASTM D6525	≥0.25	in
Tensile Strength (MD)	ASTM D6818	225	lbs/ft
Tensile Strength (TD)	ASTM D6818	175	lbs/ft
Vegetation Establishment (Min)	ASTM D7322	250	%
UV Stability ¹	ASTM D4355	≥80	%

¹ASTM D4355 Tensile Strength and % strength retention of material after 1,000 hours of exposure.

PSRM shall also meet the minimum performance values by type as shown in the table below:

Property	Test Method	Type 1	Type 2	Type 3	Type 4	Type 5	Unit
Maximum Permissible Shear Stress (Unvegetated)	ASTM 6460	2.25	2.5	3.0	3.25	N/A	lb/ft ²
Maximum Permissible Shear Stress (Vegetated)	ASTM 6460	6.0	8.0	10.0	12.0	16.0	lb/ft ²

Maximum Allowable Velocity (Vegetated)	ASTM 6460	8.0	12	16.0	20.0	24.0	ft/s
----------------------------------------	-----------	-----	----	------	------	------	------

Staples shall be used as anchors. Provide staples to meet Article 1060-8 of the *Standard Specifications*.

Construction Methods

All areas to be protected with the PSRM shall be brought to final grade and prepared in accordance with Section 1660 of the *Standard Specifications*. The surface of the soil shall be smooth, firm, stable and free of rocks, clods, roots or other obstructions that would prevent the mat from lying in direct contact with the soil surface. Preserve the required line, grade and cross section of the area covered. Unroll the PSRM in the direction of the flow of water and apply without stretching so that it will lie smoothly but loosely on the soil surface. Bury the up-channel or top of slope end of each piece of PSRM in a narrow trench at least 6 inches deep and tamp firmly. Where one roll of matting ends and a second-roll begins, overlap the end of the upper roll over the beginning of the second roll so there is a 6 inch overlap. Install staple checks 4 inches on center and every 30 feet longitudinally in the matting or as directed by the Engineer. Fold over and bury matting to the full depth of the trench, close and tamp firmly. Overlap matting at least 4 inches where 2 or more widths of matting are laid side by side.

Place staples across matting at ends, junctions and check trenches approximately 10 inches apart. Place staples along the outer edges and down the center of each strip of matting 3 feet apart. Place staples along all lapped edges 10 inches apart. Install product with netting and biodegradable fibers on the top side if present. Trenching and stapling shall fit individual cut or fill slope conditions and conform to manufacturer’s installation recommendations for the type specified. Any conflict between the manufacturer’s installation recommendations and this special provision will be resolved by the more stringent measures being required.

Apply all soil amendments and one-half of the seed in accordance with Section 1660 of the *Standard Specifications* of the types at the rates specified in the contract prior to installation of the PSRM. For PSRMs that do not contain biodegradable fibers, apply 3/4 inch to 1 inch loose, friable topsoil uniformly over the PSRM and gently work to incorporate into the structure of the PSRM completely filling the voids until the level of soil is at the top of the PSRM. Apply the remainder of the seed and gently work into the surface of the topsoil in-fill and mulch. For all other PSRMs, apply 3/4 inch to 1 inch of loose, friable topsoil uniformly over the PSRM and gently work to create a suitable seed bed. Apply the remainder of the seed and gently work into the surface of the topsoil. At the sole discretion of the Engineer, topsoil may be omitted for PSRMs containing biodegradable fibers. All seed should be applied prior to installation of PSRM if topsoil is omitted and will not need to be mulched.

Measurement and Payment

Permanent Soil Reinforcement Mat, Type __ will be measured and paid for as the actual number of square yards measured along the surface of the ground over which permanent soil reinforcement mat of the specified type is installed and accepted. Overlaps will not be included in the

measurement and will be considered as incidental to the work. Such price and payment shall be full compensation for all work covered by this provision, including, but not limited to, furnishing all materials, labor, equipment and incidentals necessary to apply topsoil and install the PSRM.

Payment will be made under:

Pay Item	Pay Unit
Permanent Soil Reinforcement Mat, Type ___	Square Yard

IMPERVIOUS DIKE:

(9-9-11)(Rev. 11-15-22)

Description

This work consists of furnishing, installing, maintaining, pumping and removing an *Impervious Dike* for the purpose of diverting normal stream flow around the construction site. The Contractor shall construct an impervious dike in such a manner approved by the Engineer. The impervious dike shall not permit seepage of water into the construction site or contribute to siltation of the stream. The impervious dike shall be constructed of an acceptable material in the locations noted on the plans or as directed by the Engineer.

Materials

Acceptable materials shall include but not be limited to sheet piles, sandbags, and/or the placement of an acceptable size stone lined with polypropylene or other impervious geotextile.

Earth material shall not be used to construct an impervious dike when it is in direct contact with the stream unless vegetation can be established before contact with the stream takes place.

Construction Methods

Where impervious dikes are shown on the plans and used to dewater or lower the water elevation, construct in accordance with Article 410-4 and 410-5.

Measurement and Payment

Impervious Dike will be measured and paid as the actual number of linear feet of impervious dike(s) constructed, measured in place from end to end of each separate installation that has been completed and accepted by the Engineer. Such price and payment will be full compensation for all work including but not limited to furnishing materials, construction, maintenance, pumping and removal of the impervious dike.

Payment will be made under:

Pay Item	Pay Unit
-----------------	-----------------

Impervious Dike

Linear Foot

TEMPORARY PIPE FOR CULVERT CONSTRUCTION:**Description**

This work consists of furnishing, installing, maintaining and removing any and all temporary pipe used on this project in conjunction with the culvert construction.

Construction Methods

The Contractor shall install temporary pipe in locations shown on the plans in such a manner approved by the Engineer. The temporary pipe shall provide a passageway for the stream through the work-site. The minimum size requirements will be as stated on the erosion control plans.

Measurement and Payment

___" *Temporary Pipe* will be measured and paid for at the contract unit price per linear foot of temporary pipe approved by the Engineer and measured in place from end to end. Such price and payment will be full compensation for all work covered by this section including but not limited to furnishing all materials required for installation, construction, maintenance, and removal of temporary pipe.

Payment will be made under:

Pay Item

___" Temporary Pipe

Pay Unit

Linear Foot

CONCRETE WASHOUT STRUCTURE:

(8-17-23)

Description

Concrete washout structures are enclosures above or below grade to contain concrete waste water and associated concrete mix from washing out ready-mix trucks, drums, pumps, or other equipment. Concrete washouts must collect and retain all the concrete washout water and solids, so that this material does not migrate to surface waters or into the ground water. These enclosures are not intended for concrete waste not associated with wash out operations.

The concrete washout structure may include constructed devices above or below ground and or commercially available devices designed specifically to capture concrete wash water.

Materials**Item**

Temporary Silt Fence

Section

1605

Safety Fence shall meet the specifications as provided elsewhere in this contract.

Geomembrane basin liner shall meet the following minimum physical properties for low permeability; it shall consist of a polypropylene or polyethylene 10 mil thick geomembrane. If the minimum setback dimensions can be achieved the liner is not required. (5 feet above groundwater, 50 feet from top of bank of perennial stream, other surface water body, or wetland.)

Construction Methods

Build an enclosed earthen berm or excavate to form an enclosure in accordance with the details and as directed.

Install temporary silt fence around the perimeter of the enclosure in accordance with the details and as directed if structure is not located in an area where existing erosion and sedimentation control devices are capable to containing any loss of sediment.

Post a sign with the words “Concrete Washout” in close proximity of the concrete washout area, so it is clearly visible to site personnel. Install safety fence as directed for visibility to construction traffic.

Alternate details for accommodating concrete washout may be submitted for review and approval.

The alternate details shall include the method used to retain and dispose of concrete waste water within the project limits and in accordance with the minimum setback requirements. (5 feet above groundwater, 50 feet from top of bank of perennial stream, other surface water body, or wetland.)

Maintenance and Removal

Maintain the concrete washout structure(s) to provide adequate holding capacity plus a minimum freeboard of 12 inches. Remove and dispose of hardened concrete and return the structure to a functional condition after reaching 75% capacity.

Inspect concrete washout structures for damage and maintain for effectiveness.

Remove the concrete washout structures and sign upon project completion. Grade the earth material to match the existing contours and permanently seed and mulch area.

Measurement and Payment

Concrete Washout Structure will be paid for per each enclosure installed in accordance with the details. If alternate details or commercially available devices are approved, then those devices will also be paid for per each approved and installed device.

Temporary Silt Fence will be measured and paid for in accordance with Article 1605-5 of the *Standard Specifications*.

Safety Fence shall be measured and paid for as provided elsewhere in this contract.

No measurement will be made for other items or for over excavation or stockpiling.

Payment will be made under:

Pay Item	Pay Unit
Concrete Washout Structure	Each

FABRIC INSERT INLET PROTECTION

(1-1-24)

Description

Install, maintain, and remove Fabric Insert Inlet Protection, of the type specified, in inlet structures (catch basins, drop inlets, etc.) in areas where asphalt or concrete may prevent the proper installation of a Rock Inlet Sediment Traps Type C, or as directed by the Engineer.

Materials

Provide a fabric inlet protection device composed of a fitted woven polypropylene geotextile double sewn with nylon thread suspended sack. The Fabric Insert Inlet Protection shall be manufactured to fit the opening of the catch basin or drop inlet or shall have a deflector to direct runoff from the curb opening into the fabric sack. The Fabric Insert Inlet Protection shall have a rigid frame or support system to support the loaded weight of the product. The product shall have lifting loops for removing the device from the basin and will have dump straps attached at the bottom to facilitate the emptying of the device. The Fabric Insert Inlet Protection shall have an overflow system to allow stormwater to enter the inlet structure and avoid ponding on the roadway when the device reaches capacity.

The fitted filter assembly shall have the following physical properties:

Type 1 (High Flow):

Physical	Test Method	English
Grab Tensile	ASTM D-4632	255 x 275 lbs
Minimum Puncture Strength	ASTM D-4833	125 lbs
Mullen Burst	ASTM D-3786	420 PSI
Minimum UV Resistance	ASTM D-4355	70 %.
Flow Rate	ASTM D-4491	200 gal/min/ft ²
Apparent Opening	ASTM D-4751	20 US Sieve
Permittivity	ASTM D-4491	1.5 sec ⁻¹

Type 2 (Low Flow):

Physical	Test Method	English
Grab Tensile	ASTM D-4632	315 x 300 lbs
Grab Elongation	ASTM D-4632	15 x 15 %
Minimum Puncture Strength	ASTM D-4833	125 lbs
Mullen Burst	ASTM D-3786	650 PSI
Minimum UV Resistance	ASTM D-4355	70 %.
Flow Rate	ASTM D-4491	40 gal/min/ft ²
Apparent Opening	ASTM D-4751	40 US Sieve
Permittivity	ASTM D-4491	0.55 sec ⁻¹

Construction Methods

Strictly adhere to the manufacturer’s installation instructions and recommendations. Maintenance shall include regular daily inspections and after each qualifying rain event. The Fabric Insert Inlet Protection shall be emptied, cleaned and placed back into the basin when it reaches 50% capacity or as directed by the Engineer.

Measurement and Payment

Fabric Insert Inlet Protection, Type __ will be measured and paid in units of each of the type specified, complete in place and accepted. Such payment shall be full compensation for furnishing and installing the *Fabric Insert Inlet Protection, Type __* in accordance with this specification and for all required maintenance.

Fabric Insert Inlet Protection Cleanout will be measured and paid in units of each for the maintenance of the device, cleanout and disposal of accumulated sediments.

Payment will be made under:

Pay Item	Pay Unit
Fabric Insert Inlet Protection, Type __	Each
Fabric Insert Inlet Protection Cleanout	Each

U-4713A

TS-1

Mecklenburg County

Signals and Intelligent Transportation Systems
Project Special Provisions
(Version 24.0)

Prepared By: SPP//SLP
11-Jul-24

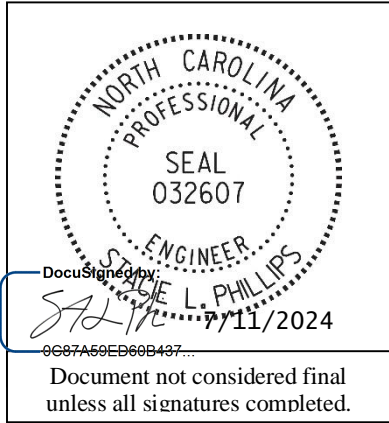

Contents

1. SIGNAL HEADS..... 3

1.1. MATERIALS 3

A. General: 3

B. Vehicle Signal Heads: 4

C. Pedestrian Signal Heads: 6

2. CONTROLLERS WITH CABINETS 8

2.1. MATERIALS – TYPE 2070LX CONTROLLERS 8

2.2. MATERIALS – GENERAL CABINETS 8

2.3. MATERIALS – TYPE 170E CABINETS 9

A. Type 170 E Cabinets General: 9

B. Type 170 E Cabinet Electrical Requirements: 10

C. Type 170 E Cabinet Physical Requirements: 16

D. Model 2018 Enhanced Conflict Monitor: 17

2.4. MATERIALS – TYPE 170 DETECTOR SENSOR UNITS 27

3. VIDEO IMAGING LOOP EMULATOR DETECTOR SYSTEMS FOR TEMPORARY INSTALLATION 27

3.1. DESCRIPTION 27

3.2. MATERIALS 28

A. General: 28

B. Loop Emulator System: 29

C. Video Imaging Loop Emulator System Support: 30

3.3. CONSTRUCTION METHODS 30

3.4. MEASUREMENT AND PAYMENT 31

4. METAL POLE SUPPORTS 32

4.1. METAL POLES 32

A. General: 32

B. Materials: 33

C. Design: 35

D. Strain Poles: 37

4.2. DRILLED PIER FOUNDATIONS FOR METAL POLES 38

A. Description: 38

B. Soil Test and Foundation Determination: 39

C. Drilled Pier Construction: 41

4.3. POLE NUMBERING SYSTEM 41

A. New Poles 41

4.4. MEASUREMENT AND PAYMENT 41

5. ETHERNET EDGE SWITCH 42

5.1. DESCRIPTION 42

A. Ethernet Edge Switch: 42

U-4713A

TS-2

Mecklenburg County

- B. Network Management: 42
- 5.2. MATERIALS 42
 - A. General: 42
 - B. Compatibility Acceptance..... 42
 - C. Standards: 42
 - D. Functional: 43
 - E. Physical Features:..... 44
 - F. Management Capabilities: 44
 - G. Electrical Specifications: 45
 - H. Environmental Specifications: 46
 - I. Ethernet Patch Cable: 46
- 5.3. CONSTRUCTION METHODS..... 46
 - A. General: 46
 - B. Edge Switch: 47
- 5.4. MEASURMENT AND PAYMENT 47

1. SIGNAL HEADS

1.1. MATERIALS

A. General:

Fabricate vehicle signal head housings and end caps from die-cast aluminum. Fabricate 16-inch pedestrian signal head housings and end caps from die-cast aluminum. Provide visor mounting screws, door latches, and hinge pins fabricated from stainless steel. Provide interior screws, fasteners, and metal parts fabricated from stainless steel.

Fabricate tunnel and traditional visors from sheet aluminum.

Paint all surfaces inside and outside of signal housings and doors. Paint outside surfaces of tunnel and traditional visors, wire outlet bodies, wire entrance fitting brackets and end caps when supplied as components of messenger cable mounting assemblies, pole and pedestal mounting assemblies, and pedestrian pushbutton housings. Have electrostatically-applied, fused-polyester paint in highway yellow (Federal Standard 595C, Color Chip Number 13538) a minimum of 2.5 to 3.5 mils thick. Do not apply paint to the latching hardware, rigid vehicle signal head mounting brackets for mast-arm attachments, messenger cable hanger components or balance adjuster components.

Have the interior surfaces of tunnel and traditional visors painted an alkyd urea black synthetic baking enamel with a minimum gloss reflectance and meeting the requirements of MIL-E-10169, "Enamel Heat Resisting, Instrument Black."

Where required, provide polycarbonate signal heads and visors that comply with the provisions pertaining to the aluminum signal heads listed on the QPL with the following exceptions:

Fabricate signal head housings, end caps, and visors from virgin polycarbonate material. Provide UV stabilized polycarbonate plastic with a minimum thickness of 0.1 ± 0.01 inches that is highway yellow (Federal Standard 595C, Color Chip 13538). Ensure the color is incorporated into the plastic material before molding the signal head housings and end caps. Ensure the plastic formulation provides the following physical properties in the assembly (tests may be performed on separately molded specimens):

Test	Required	Method
Specific Gravity	1.17 minimum	ASTM D 792
Flammability	Self-extinguishing	ASTM D 635
Tensile Strength, yield, PSI	8500 minimum	ASTM D 638
Izod impact strength, ft-lb/in [notched, 1/8 inch]	12 minimum	ASTM D 256

For pole mounting, provide side of pole mounting assemblies with framework and all other hardware necessary to make complete, watertight connections of the signal heads to the poles and pedestals. Fabricate the mounting assemblies and frames from aluminum with all necessary hardware, screws, washers, etc. to be stainless steel. Provide mounting fittings that match the positive locking device on the signal head with the serrations integrally cast into the brackets. Provide upper and lower pole plates that have a 1 ¼-inch vertical conduit entrance hubs with the hubs capped on the lower plate and 1 ½-inch horizontal hubs. Ensure that the assemblies provide rigid attachments to poles and pedestals so as to allow no twisting or swaying of the signal heads. Ensure that all raceways are free of sharp edges and protrusions, and can accommodate a minimum of ten Number 14 AWG conductors.

U-4713A**TS-4****Mecklenburg County**

For pedestal mounting, provide a post-top slipfitter mounting assembly that matches the positive locking device on the signal head with serrations integrally cast into the slipfitter. Provide stainless steel hardware, screws, washers, etc. Provide a minimum of six 3/8 X 3/4-inch long square head bolts for attachment to pedestal. Provide a center post for multi-way slipfitters.

For light emitting diode (LED) traffic signal modules, provide the following requirements for inclusion on the Department's Qualified Products List for traffic signal equipment.

1. Sample submittal,
2. Third-party independent laboratory testing results for each submitted module with evidence of testing and conformance with all of the Design Qualification Testing specified in section 6.4 of each of the following Institute of Transportation Engineers (ITE) specifications:
 - Vehicle Traffic Control Signal Heads – Light Emitting Diode (LED) Circular Signal Supplement
 - Vehicle Traffic Control Signal Heads – Light Emitting Diode (LED) Vehicle Arrow Traffic Signal Supplement
 - Pedestrian Traffic Control Signal Indications –Light Emitting Diode (LED) Signal Modules.

(Note: The Department currently recognizes two approved independent testing laboratories. They are Intertek ETL Semko and Light Metrics, Incorporated with Garwood Laboratories. Independent laboratory tests from other laboratories may be considered as part of the QPL submittal at the discretion of the Department,

3. Evidence of conformance with the requirements of these specifications,
4. A manufacturer's warranty statement in accordance with the required warranty, and
5. Submittal of manufacturer's design and production documentation for the model, including but not limited to, electrical schematics, electronic component values, proprietary part numbers, bill of materials, and production electrical and photometric test parameters.
6. Evidence of approval of the product to bear the Intertek ETL Verified product label for LED traffic signal modules.

Ensure LED traffic signal modules meet the performance requirements for the minimum period of 15 years, provide a written warranty against defects in materials and workmanship for the modules for a period of 15 years after installation of the modules. During the warranty period, the manufacturer must provide new replacement modules within 45 days of receipt of modules that have failed at no cost to the State. Repaired or refurbished modules may not be used to fulfill the manufacturer's warranty obligations. Provide manufacturer's warranty documentation to the Department during evaluation of product for inclusion on Qualified Products List (QPL).

B. Vehicle Signal Heads:

Comply with the ITE standard "Vehicle Traffic Control Signal Heads". Provide housings with provisions for attaching backplates.

Provide visors that are 10 inches in length for 12-inch vehicle signal heads.

Provide a termination block with one empty terminal for field wiring for each indication plus one empty terminal for the neutral conductor. Have all signal sections wired to the termination block. Provide barriers between the terminals that have terminal screws with a minimum Number 8 thread size and that will accommodate and secure spade lugs sized for a Number 10 terminal screw.

Mount termination blocks in the yellow signal head sections on all in-line vehicle signal heads. Mount the termination block in the red section on five-section vehicle signal heads.

Furnish vehicle signal head interconnecting brackets. Provide one-piece aluminum brackets less than 4.5 inches in height and with no threaded pipe connections. Provide hand holes on the bottom of the brackets to aid in installing wires to the signal heads. Lower brackets that carry no wires and are used only for connecting the bottom signal sections together may be flat in construction.

For messenger cable mounting, provide messenger cable hangers, wire outlet bodies, balance adjusters, bottom caps, wire entrance fitting brackets, and all other hardware necessary to make complete, watertight connections of the vehicle signal heads to the messenger cable. Fabricate messenger cable hanger components, wire outlet bodies and balance adjuster components from stainless steel or malleable iron galvanized in accordance with ASTM A153 (Class A) or ASTM A123. Provide serrated rings made of aluminum. Provide messenger cable hangers with U-bolt clamps. Fabricate washers, screws, hex-head bolts and associated nuts, clevis pins, cotter pins, U-bolt clamps and nuts from stainless steel.

Provide LED vehicular traffic signal modules (hereafter referred to as modules) that consist of an assembly that uses LEDs as the light source in lieu of an incandescent lamp for use in traffic signal sections. Use LEDs that are aluminum indium gallium phosphorus (AlInGaP) technology for red and yellow indications and indium gallium nitride (InGaN) for green indications. Install the ultra bright type LEDs that are rated for 100,000 hours of continuous operation from -40°F to +165°F. Design modules to have a minimum useful life of 15 years and to meet all parameters of this specification during this period of useful life.

For the modules, provide spade terminals crimped to the lead wires and sized for a #10 screw connection to the existing terminal block in a standard signal head. Do not provide other types of crimped terminals with a spade adapter.

Ensure the power supply is integral to the module assembly. On the back of the module, permanently mark the date of manufacture (month & year) or some other method of identifying date of manufacture.

Tint the red, yellow and green lenses to correspond with the wavelength (chromaticity) of the LED. Transparent tinting films are unacceptable. Provide a lens that is integral to the unit with a smooth outer surface.

1. LED Circular Signal Modules:

Provide modules in the following configurations: 12-inch circular sections. All makes and models of LED modules purchased for use on the State Highway System shall appear on the current NCDOT Traffic Signal Qualified Products List (QPL).

Provide the manufacturer’s model number and the product number (assigned by the Department) for each module that appears on the 2024 or most recent Qualified Products List. In addition, provide manufacturer’s certification in accordance with Article 106-3 of the *Standard Specifications*, that each module meets or exceeds the ITE “Vehicle Traffic Control Signal Heads – Light Emitting Diode (LED) Circular Signal Supplement” dated June 27, 2005 (hereafter referred to as VTCSH Circular Supplement) and other requirements stated in this specification.

Provide modules that meet the following requirements when tested under the procedures outlined in the VTCSH Circular Supplement:

Module Type	Max. Wattage at 165° F	Nominal Wattage at 77° F
12-inch red circular	17	11

12-inch green circular	15	15
------------------------	----	----

For yellow circular signal modules, provide modules tested under the procedures outlined in the VTCSH Circular Supplement to insure power required at 77° F is 22 Watts or less for the 12-inch circular module.

Note: Use a wattmeter having an accuracy of ±1% to measure the nominal wattage and maximum wattage of a circular traffic signal module. Power may also be derived from voltage, current and power factor measurements.

2. LED Arrow Signal Modules

Provide 12-inch omnidirectional arrow signal modules. All makes and models of LED modules purchased for use on the State Highway System shall appear on the current NCDOT Traffic Signal Qualified Products List (QPL).

Provide the manufacturer’s model number and the product number (assigned by the Department) for each module that appears on the 2024 or most recent Qualified Products List. In addition, provide manufacturer’s certification in accordance with Article 106-3 of the *Standard Specifications*, that each module meets or exceeds the requirements for 12-inch omnidirectional modules specified in the ITE “Vehicle Traffic Control Signal Heads – Light Emitting Diode (LED) Vehicle Arrow Traffic Signal Supplement” dated July 1, 2007 (hereafter referred to as VTCSH Arrow Supplement) and other requirements stated in this specification.

Provide modules that meet the following requirements when tested under the procedures outlined in the VTCSH Arrow Supplement:

Module Type	Max. Wattage at 165° F	Nominal Wattage at 77° F
12-inch red arrow	12	9
12-inch green arrow	11	11

For yellow arrow signal modules, provide modules tested under the procedures outlined in the VTCSH Arrow Supplement to insure power required at 77° F is 12 Watts or less.

Note: Use a wattmeter having an accuracy of ±1% to measure the nominal wattage and maximum wattage of an arrow traffic signal module. Power may also be derived from voltage, current and power factor measurements.

C. Pedestrian Signal Heads:

Provide pedestrian signal heads with international symbols that meet the MUTCD. Do not provide letter indications.

Comply with the ITE standard for “Pedestrian Traffic Control Signal Indications” and the following sections of the ITE standard for “Vehicle Traffic Control Signal Heads” in effect on the date of advertisement:

- Section 3.00 - “Physical and Mechanical Requirements”
- Section 4.01 - “Housing, Door, and Visor: General”
- Section 4.04 - “Housing, Door, and Visor: Materials and Fabrication”
- Section 7.00 - “Exterior Finish”

Provide a double-row termination block with three empty terminals and number 10 screws for field wiring. Provide barriers between the terminals that accommodate a spade lug sized for number 10 terminal screws. Mount the termination block in the hand section. Wire all signal sections to the terminal block.

Where required by the plans, provide 16-inch pedestrian signal heads with traditional three-sided, rectangular visors, 6 inches long.

Provide 2-inch diameter pedestrian push-buttons with weather-tight housings fabricated from die-cast aluminum and threading in compliance with the NEC for rigid metal conduit. Provide a weep hole in the housing bottom and ensure that the unit is vandal resistant.

Provide push-button housings that are suitable for mounting on flat or curved surfaces and that will accept 1/2-inch conduit installed in the top. Provide units that have a heavy duty push-button assembly with a sturdy, momentary, normally-open switch. Have contacts that are electrically insulated from the housing and push-button. Ensure that the push-buttons are rated for a minimum of 5 mA at 24 volts DC and 250 mA at 12 volts AC.

Provide standard R10-3 signs with mounting hardware that comply with the MUTCD in effect on the date of advertisement. Provide R10-3E signs for countdown pedestrian heads and R10-3B for non-countdown pedestrian heads.

Design the LED pedestrian traffic signal modules (hereafter referred to as modules) for installation into standard pedestrian traffic signal sections that do not contain the incandescent signal section reflector, lens, eggcrate visor, gasket, or socket. Provide modules that consist of an assembly that uses LEDs as the light source in lieu of an incandescent lamp. Use LEDs that are of the latest aluminum indium gallium phosphorus (AlInGaP) technology for the Portland Orange hand and countdown displays. Use LEDs that are of the latest indium gallium nitride (InGaN) technology for the Lunar White walking man displays. Install the ultra-bright type LEDs that are rated for 100,000 hours of continuous operation from -40°F to +165°F. Design modules to have a minimum useful life of 60 months and to meet all parameters of this specification during this period of useful life.

Design all modules to operate using a standard 3 - wire field installation. Provide spade terminals crimped to the lead wires and sized for a #10 screw connection to the existing terminal block in a standard pedestrian signal housing. Do not provide other types of crimped terminals with a spade adapter.

Ensure the power supply is integral to the module assembly. On the back of the module, permanently mark the date of manufacture (month & year) or some other method of identifying date of manufacture.

Provide modules in the following configuration: 16-inch displays which have the solid hand/walking man overlay on the left and the countdown on the right. All makes and models of LED modules purchased for use on the State Highway System shall appear on the current NCDOT Traffic Signal Qualified Products List (QPL).

Provide the manufacturer’s model number and the product number (assigned by the Department) for each module that appears on the 2024 or most recent Qualified Products List. In addition, provide manufacturer’s certification in accordance with Article 106-3 of the *Standard Specifications*, that each module meets or exceeds the ITE “Pedestrian Traffic Control Signal Indicators - Light Emitting Diode (LED) Signal Modules” dated August 04, 2010 (hereafter referred to as PTC SI Pedestrian Standard) and other requirements stated in this specification.

Provide modules that meet the following requirements when tested under the procedures outlined in the PTC SI Pedestrian Standard:

Module Type	Max. Wattage at 165° F	Nominal Wattage at 77° F
Hand Indication	16	13
Walking Man Indication	12	9

Countdown Indication	16	13
----------------------	----	----

Note: Use a wattmeter having an accuracy of $\pm 1\%$ to measure the nominal wattage and maximum wattage of a circular traffic signal module. Power may also be derived from voltage, current and power factor measurements.

Provide module lens that is hard coated or otherwise made to comply with the material exposure and weathering effects requirements of the Society of Automotive Engineers (SAE) J576. Ensure all exposed components of the module are suitable for prolonged exposure to the environment, without appreciable degradation that would interfere with function or appearance.

Ensure the countdown display continuously monitors the traffic controller to automatically learn the pedestrian phase time and update for subsequent changes to the pedestrian phase time.

Ensure the countdown display begins normal operation upon the completion of the preemption sequence and no more than one pedestrian clearance cycle.

2. CONTROLLERS WITH CABINETS

2.1. MATERIALS – TYPE 2070LX CONTROLLERS

Furnish model 2070LX controller units that conform to CALTRANS *Transportation Electrical Equipment Specifications* (TEES) (dated March 12, 2009, plus Errata 1 dated January 21, 2010 and Errata 2 dated December 5, 2014) except as required herein.

The Department will provide software at the beginning of the burning-in period. Contractor shall give 5 working days notice before needing software. Program software provided by the Department.

Provide model 2070LX controllers with Linux kernel 2.6.18 or higher and device drivers, composed of the unit chassis and at a minimum the following modules and assemblies:

- MODEL 2070-1C, CPU Module, Single Board, with 8Mb Datakey (blue in color)
- MODEL 2070-2E+, Field I/O Module (FI/O)
 - Note: Configure the Field I/O Module to disable both the External WDT Shunt/Toggle Switch and SP3 (SP3 active indicator is “off”)
- MODEL 2070-3B, Front Panel Module (FP), Display B (8x40)
- MODEL 2070-4A, Power Supply Module, 10 AMP

Provide a Board Support Package (BSP) to the state and to any specified applications software manufacturer when requested by the state to facilitate the porting of application software.

2.2.MATERIALS – GENERAL CABINETS

Provide a moisture resistant coating on all circuit boards.

Provide one 20 mm diameter radial lead UL-recognized metal oxide varistor (MOV) between each load switch field terminal and equipment ground. Electrical performance is outlined below.

PROPERTIES OF MOV SURGE PROTECTOR	
Maximum Continuous Applied Voltage at 185° F	150 VAC (RMS) 200 VDC
Maximum Peak 8x20µs Current at 185° F	6500 A
Maximum Energy Rating at 185° F	80 J
Voltage Range 1 mA DC Test at 77° F	212-268 V
Max. Clamping Voltage 8x20µs, 100A at 77° F	395 V
Typical Capacitance (1 MHz) at 77° F	1600 pF

Provide a power line surge protector that is a two-stage device that will allow connection of the radio frequency interference filter between the stages of the device. Ensure that a maximum continuous current is at least 10A at 120V. Ensure that the device can withstand a minimum of 20 peak surge current occurrences at 20,000A for an 8x20 microsecond waveform. Provide a maximum clamp voltage of 395V at 20,000A with a nominal series inductance of 200µh. Ensure that the voltage does not exceed 395V. Provide devices that comply with the following:

Frequency (Hz)	Minimum Insertion Loss (dB)
60	0
10,000	30
50,000	55
100,000	50
500,000	50
2,000,000	60
5,000,000	40
10,000,000	20
20,000,000	25

2.3. MATERIALS – TYPE 170E CABINETS

A. Type 170 E Cabinets General:

Conform to the city of Los Angeles’ Specification No. 54-053-08, *Traffic Signal Cabinet Assembly Specification* (dated July 2008), except as required herein.

Furnish model 332 base mounted cabinets configured for 8 vehicle phases, 4 pedestrian phases, and 6 overlaps. When overlaps are required, provide auxiliary output files for the overlaps. Do not reassign load switches to accommodate overlaps unless shown on electrical details.

Provide model 200 load switches, model 222 loop detector sensors, model 252 AC isolators, and model 242 DC isolators according to the electrical details. As a minimum, provide one (1) model 2018 conflict monitor, one (1) model 206L power supply unit, two (2) model 204 flashers, one (1)

DC isolator (located in slot I14), and four (4) model 430 flash transfer relays (provide seven (7) model 430 flash transfer relays if auxiliary output file is installed) with each cabinet.

B. Type 170 E Cabinet Electrical Requirements:

Provide a cabinet assembly designed to ensure that upon leaving any cabinet switch or conflict monitor initiated flashing operation, the controller starts up in the programmed start up phases and start up interval.

Furnish two sets of non-fading cabinet wiring diagrams and schematics in a paper envelope or container and placed in the cabinet drawer.

All AC+ power is subject to radio frequency signal suppression.

Provide surge suppression in the cabinet for each type of cabinet device. Provide surge protection for the full capacity of the cabinet input file. Provide surge suppression devices that operate properly over a temperature range of -40° F to +185° F. Ensure the surge suppression devices provide both common and differential modes of protection.

Provide a pluggable power line surge protector that is installed on the back of the PDA (power distribution assembly) chassis to filter and absorb power line noise and switching transients. Ensure the device incorporates LEDs for failure indication and provides a dry relay contact closure for the purpose of remote sensing. Ensure the device meets the following specifications:

Peak Surge Current (Single pulse, 8x20µs).....	20,000A
Occurrences (8x20µs waveform).....	10 minimum @ 20,000A
Maximum Clamp Voltage.....	395VAC
Operating Current.....	15 amps
Response Time.....	< 5 nanoseconds

Provide a loop surge suppressor for each set of loop terminals in the cabinet. Ensure the device meets the following specifications:

Peak Surge Current (6 times, 8x20µs)	
(Differential Mode).....	400A
(Common Mode).....	1,000A
Occurrences (8x20µs waveform).....	500 min @ 200A
Maximum Clamp Voltage	
(Differential Mode @400A).....	35V
(Common Mode @1,000A).....	35V
Response Time.....	< 5 nanoseconds
Maximum Capacitance.....	35 pF

Provide a data communications surge suppressor for each communications line entering or leaving the cabinet. Ensure the device meets the following specifications:

Peak Surge Current (Single pulse, 8x20µs).....	10,000A
------------------------------------------------	---------

U-4713A

TS-11

Mecklenburg County

Occurrences (8x20µs waveform).....	100 min @ 2,000A
Maximum Clamp Voltage.....	Rated for equipment protected
Response Time.....	< 1 nanosecond
Maximum Capacitance.....	1,500 pF
Maximum Series Resistance.....	15Ω

Provide a DC signal surge suppressor for each DC input channel in the cabinet. Ensure the device meets the following specifications:

Peak Surge Current (Single pulse, 8x20µs).....	10,000A
Occurrences (8x20µs waveform).....	100 @ 2,000A
Maximum Clamp Voltage.....	30V
Response Time.....	< 1 nanosecond

Provide a 120 VAC signal surge suppressor for each AC+ interconnect signal input. Ensure the device meets the following specifications:

Peak Surge Current (Single pulse, 8x20µs).....	20,000A
Maximum Clamp Voltage.....	350VAC
Response Time.....	< 200 nanoseconds
Discharge Voltage.....	<200 Volts @ 1,000A
Insulation Resistance.....	≥100 MΩ

Provide conductors for surge protection wiring that are of sufficient size (ampacity) to withstand maximum overcurrents which could occur before protective device thresholds are attained and current flow is interrupted.

If additional surge protected power outlets are needed to accommodate fiber transceivers, modems, etc., install a UL listed, industrial, heavy-duty type power outlet strip with a minimum rating of 15 A / 125 VAC, 60 Hz. Provide a strip that has a minimum of 3 grounded outlets. Ensure the power outlet strip plugs into one of the controller unit receptacles located on the rear of the PDA. Ensure power outlet strip is mounted securely; provide strain relief if necessary.

Provide a door switch in the front and a door switch in the rear of the cabinet that will provide the controller unit with a Door Ajar alarm when either the front or the rear door is open. Ensure the door switches apply DC ground to the Input File when either the front door or the rear door is open.

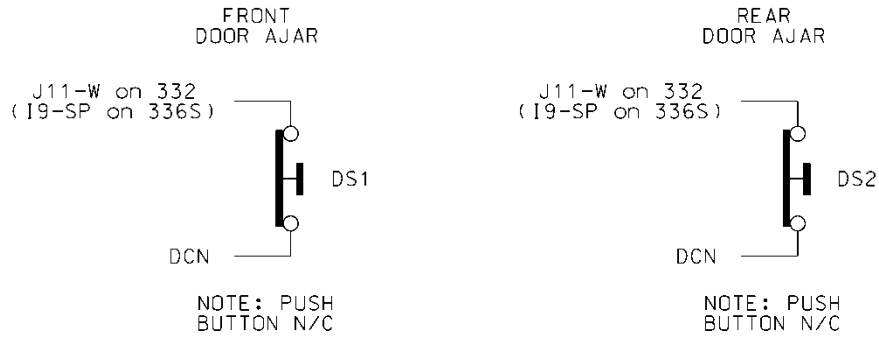

Furnish a fluorescent fixture in the rear across the top of the cabinet and another fluorescent fixture in the front across the top of the cabinet at a minimum. Ensure that the fixtures provide sufficient light to illuminate all terminals, labels, switches, and devices in the cabinet. Conveniently locate the fixtures so as not to interfere with a technician's ability to perform work on any devices or terminals in the cabinet. Provide a protective diffuser to cover exposed bulbs. Install 16 watt T-4 lamps in the fluorescent fixtures. Provide a door switch to provide power to each fixture when the respective door is open. Wire the fluorescent fixtures to the 15 amp ECB (equipment circuit breaker).

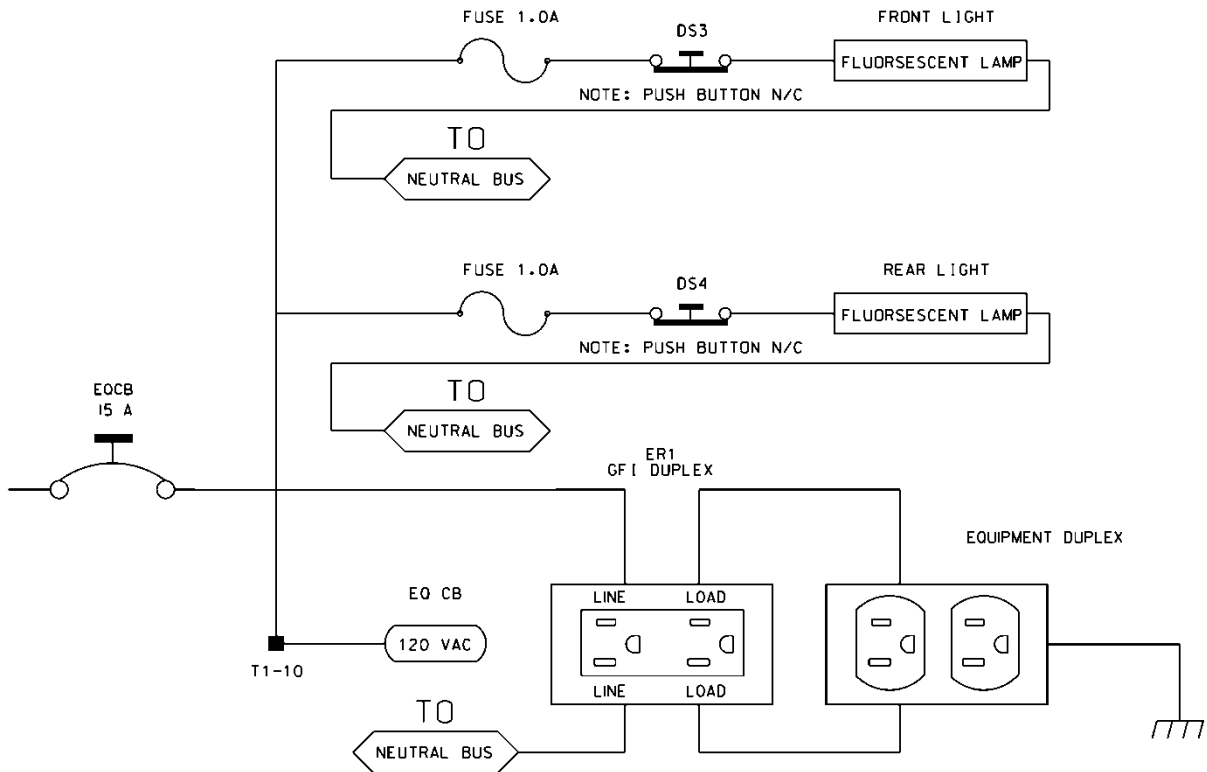

Furnish a police panel with a police panel door. Ensure that the police panel door permits access to the police panel when the main door is closed. Ensure that no rainwater can enter the cabinet even with the police panel door open. Provide a police panel door hinged on the right side as viewed from the front. Provide a police panel door lock that is keyed to a standard police/fire call box key. In

addition to the requirements of LA Specification No. 54-053-08, provide the police panel with a toggle switch connected to switch the intersection operation between normal stop-and-go operation (AUTO) and manual operation (MANUAL). Ensure that manual control can be implemented using inputs and software such that the controller provides full programmed clearance times for the yellow clearance and red clearance for each phase while under manual control.

Provide a 1/4-inch locking phone jack in the police panel for a hand control to manually control the intersection. Provide sufficient room in the police panel for storage of a hand control and cord.

For model 332 base mounted cabinets, ensure terminals J14-E and J14-K are wired together on the rear of the Input File. Connect TB9-12 (J14 Common) on the Input Panel to T1-2 (AC-) on the rear of the PDA.

Provide detector test switches mounted at the top of the cabinet rack or other convenient location which may be used to place a call on each of eight phases based on the chart below. Provide three positions for each switch: On (place call), Off (normal detector operation), and Momentary On (place momentary call and return to normal detector operation after switch is released). Ensure that the switches are located such that the technician can read the controller display and observe the intersection.

Connect detector test switches for cabinets as follows:

332 Cabinet	
Detector Call Switches	Terminals
Phase 1	I1-W
Phase 2	I4-W
Phase 3	I5-W
Phase 4	I8-W
Phase 5	J1-W
Phase 6	J4-W
Phase 7	J5-W
Phase 8	J8-W

Provide the PCB 28/56 connector for the conflict monitor unit (CMU) with 28 independent contacts per side, dual-sided with 0.156 inch contact centers. Provide the PCB 28/56 connector contacts with solder eyelet terminations. Ensure all connections to the PCB 28/56 connector are soldered to the solder eyelet terminations.

Ensure that all cabinets have the CMU connector wired according to the 332 cabinet connector pin assignments (include all wires for auxiliary output file connection). Wire pins 13, 16, R, and U of the CMU connector to a separate 4 pin plug, P1, as shown below. Provide a second plug, P2, which will mate with P1 and is wired to the auxiliary output file as shown below. Provide an additional plug, P3, which will mate with P1 and is wired to the pedestrian yellow circuits as shown below. When no auxiliary output file is installed in the cabinet, provide wires for the green and yellow inputs for channels 11, 12, 17, and 18, the red inputs for channels 17 and 18, and the wires for the P2 plug. Terminate the two-foot wires with ring type lugs, insulated, and bundled for optional use.

PIN	P1		P2		P3	
	FUNCTION	CONN TO	FUNCTION	CONN TO	FUNCTION	CONN TO
1	CH-9G	CMU-13	OLA-GRN	A123	2P-YEL	114
2	CH-9Y	CMU-16	OLA-YEL	A122	4P-YEL	105
3	CH-10G	CMU-R	OLB-GRN	A126	6P-YEL	120
4	CH-10Y	CMU-U	OLB-YEL	A125	8P-YEL	111

Do not provide the P20 terminal assembly (red monitor board) or red interface ribbon cable as specified in LA Specification No. 54-053-08.

Provide a P20 connector that mates with and is compatible with the red interface connector mounted on the front of the conflict monitor. Ensure that the P20 connector and the red interface connector on the conflict monitor are center polarized to ensure proper connection. Ensure that removal of the P20 connector will cause the conflict monitor to recognize a latching fault condition and place the cabinet into flashing operation.

Wire the P20 connector to the output file and auxiliary output file using 22 AWG stranded wires. Ensure the length of these wires is a minimum of 42 inches in length. Provide a durable braided sleeve around the wires to organize and protect the wires.

Wire the P20 connector to the traffic signal red displays to provide inputs to the conflict monitor as shown below. Ensure the pedestrian Don't Walk circuits are wired to channels 13 through 16 of the P20 connector. When no auxiliary output file is installed in the cabinet, provide wires for channels 9 through 12 reds. Provide a wire for special function 1. Terminate the unused wires with ring type lugs, insulated, and bundled for optional use.

P20 Connector					
PIN	FUNCTION	CONN TO	PIN	FUNCTION	CONN TO
1	Channel 15 Red	119	2	Channel 16 Red	110
3	Channel 14 Red	104	4	Chassis GND	01-9
5	Channel 13 Red	113	6	N/C	
7	Channel 12 Red	AUX 101	8	Spec Function 1	
9	Channel 10 Red	AUX 124	10	Channel 11 Red	AUX 114
11	Channel 9 Red	AUX 121	12	Channel 8 Red	107
13	Channel 7 Red	122	14	Channel 6 Red	134
15	Channel 5 Red	131	16	Channel 4 Red	101
17	Channel 3 Red	116	18	Channel 2 Red	128
19	Channel 1 Red	125	20	Red Enable	01-14

Ensure the controller unit outputs to the auxiliary output file are pre-wired to the C5 connector. When no auxiliary output file is installed in the cabinet, connect the C5 connector to a storage socket located on the Input Panel or on the rear of the PDA.

Do not wire pin 12 of the load switch sockets.

In addition to the requirements of LA Specification No. 54-053-08, ensure relay K1 on the Power Distribution Assembly (PDA) is a four pole relay and K2 on the PDA is a two pole relay.

Provide a two pole, ganged circuit breaker for the flash bus circuit. Ensure the flash bus circuit breaker is an inverse time circuit breaker rated for 10 amps at 120 VAC with a minimum of 10,000 RMS symmetrical amperes short circuit current rating. Do not provide the auxiliary switch feature on the flash bus circuit breaker. Ensure the ganged flash bus circuit breaker is certified by the circuit breaker manufacturer to provide ganging tripping operation.

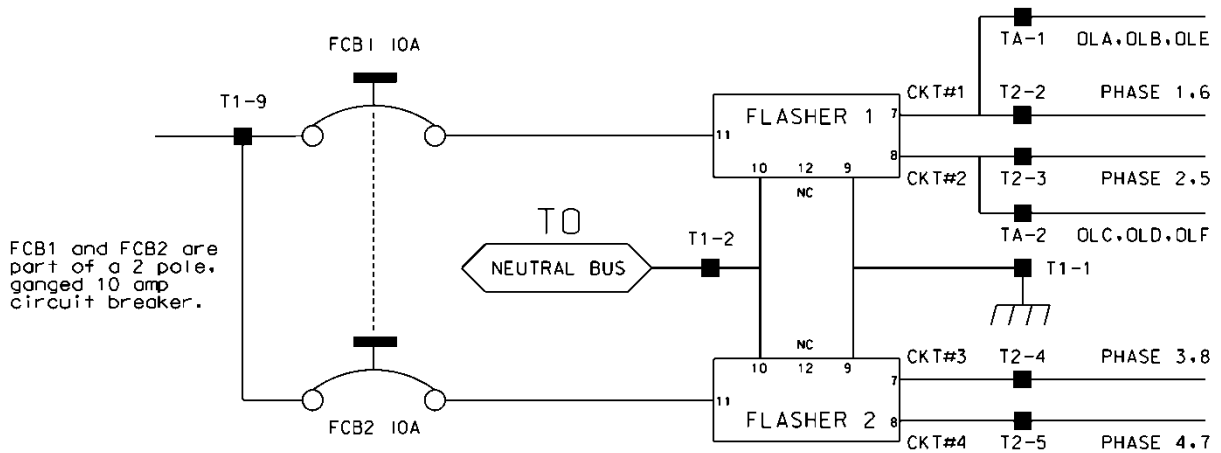

Ensure auxiliary output files are wired as follows:

AUXILIARY OUTPUT FILE TERMINAL BLOCK TA ASSIGNMENTS	
POSITION	FUNCTION
1	Flasher Unit #1, Circuit 1/FTR1 (OLA, OLB)/FTR3 (OLE)
2	Flasher Unit #1, Circuit 2/FTR2 (OLC, OLD)/FTR3 (OLF)
3	Flash Transfer Relay Coils
4	AC -
5	Power Circuit 5
6	Power Circuit 5
7	Equipment Ground Bus
8	NC

Provide four spare load resistors mounted in each cabinet. Ensure each load resistor is rated as shown in the table below. Wire one side of each load resistor to AC-. Connect the other side of each resistor to a separate terminal on a four (4) position terminal block. Mount the load resistors

and terminal block either inside the back of Output File No. 1 or on the upper area of the Service Panel.

ACCEPTABLE LOAD RESISTOR VALUES	
VALUE (ohms)	WATTAGE
1.5K – 1.9 K	25W (min)
2.0K – 3.0K	10W (min)

Provide Model 200 load switches, Model 204 flashers, Model 242 DC isolators, Model 252 AC isolators, and Model 206L power supply units that conform to CALTRANS’ *“Transportation Electrical Equipment Specifications”* dated March 12, 2009 with Erratum 1.

C. Type 170 E Cabinet Physical Requirements:

Do not mold, cast, or scribe the name “City of Los Angeles” on the outside of the cabinet door as specified in LA Specification No. 54-053-08. Do not provide a Communications Terminal Panel as specified in LA Specification No. 54-053-08. Do not provide terminal block TBB on the Service Panel. Do not provide Cabinet Verification Test Program software or associated test jigs as specified in LA Specification No. 54-053-08.

Furnish unpainted, natural, aluminum cabinet shells. Ensure that all non-aluminum hardware on the cabinet is stainless steel or a Department approved non-corrosive alternate.

Ensure the lifting eyes, gasket channels, police panel, and all supports welded to the enclosure and doors are fabricated from 0.125 inch minimum thickness aluminum sheet and meet the same standards as the cabinet and doors.

Provide front and rear doors with latching handles that allow padlocking in the closed position. Furnish 0.75 inch minimum diameter stainless steel handles with a minimum 0.5 inch shank. Place the padlocking attachment at 4.0 inches from the handle shank center to clear the lock and key. Provide an additional 4.0 inches minimum gripping length.

Provide Corbin #2 locks on the front and rear doors. Provide one (1) Corbin #2 and one (1) police master key with each cabinet. Ensure main door locks allow removal of keys in the locked position only.

Provide a surge protection panel with 16 loop surge protection devices and designed to allow sufficient free space for wire connection/disconnection and surge protection device replacement. For model 332 cabinets, provide an additional 20 loop surge protection devices. Provide an additional two AC+ interconnect surge devices to protect one slot and eight DC surge protection devices to protect four slots. Provide no protection devices on slot I14.

For base mounted cabinets, mount surge protection panels on the left side of the cabinet as viewed from the rear. Attach each panel to the cabinet rack assembly using bolts and make it easily removable. Mount the surge protection devices in vertical rows on each panel and connect the devices to one side of 12 position, double row terminal blocks with #8 screws. For each surge protection panel, terminate all grounds from the surge protection devices on a copper equipment ground bus attached to the surge protection panel. Wire the terminals to the rear of a standard input file using spade lugs for input file protection.

Provide permanent labels that indicate the slot and the pins connected to each terminal that may be viewed from the rear cabinet door. Label and orient terminals so that each pair of inputs is next to each other. Indicate on the labeling the input file (I or J), the slot number (1-14) and the terminal pins of the input slots (either D & E for upper or J & K for lower).

Provide a minimum 14 x 16 inch pull out, hinged top shelf located immediately below controller mounting section of the cabinet. Ensure the shelf is designed to fully expose the table surface outside the controller at a height approximately even with the bottom of the controller. Ensure the shelf has a storage bin interior which is a minimum of 1 inch deep and approximately the same dimensions as the shelf. Provide an access to the storage area by lifting the hinged top of the shelf. Fabricate the shelf and slide from aluminum or stainless steel and ensure the assembly can support the 2070L controller plus 15 pounds of additional weight. Ensure shelf has a locking mechanism to secure it in the fully extended position and does not inhibit the removal of the 2070L controller or removal of cards inside the controller when fully extended. Provide a locking mechanism that is easily released when the shelf is to be returned to its non-use position directly under the controller.

D. Model 2018 Enhanced Conflict Monitor:

Furnish Model 2018 Enhanced Conflict Monitors that provide monitoring of 18 channels. Ensure each channel consists of a green, yellow, and red field signal input. Ensure that the conflict monitor meets or exceeds CALTRANS' Transportation Electrical Equipment Specifications dated March 12, 2009, with Erratum 1 (hereafter referred to as CALTRANS' 2009 TEES) for a model 210 monitor unit and other requirements stated in this specification.

Ensure the conflict monitor is provided with an 18 channel conflict programming card. Pin EE and Pin T of the conflict programming card shall be connected together. Pin 16 of the conflict programming card shall be floating. Ensure that the absence of the conflict programming card will cause the conflict monitor to trigger (enter into fault mode), and remain in the triggered state until the programming card is properly inserted and the conflict monitor is reset.

Provide a conflict monitor that incorporates LED indicators into the front panel to dynamically display the status of the monitor under normal conditions and to provide a comprehensive review of field inputs with monitor status under fault conditions. Ensure that the monitor indicates the channels that were active during a conflict condition and the channels that experienced a failure for all other per channel fault conditions detected. Ensure that these indications and the status of each channel are retained until the Conflict Monitor is reset. Furnish LED indicators for the following:

- AC Power (Green LED indicator)
- VDC Failed (Red LED indicator)
- WDT Error (Red LED indicator)
- Conflict (Red LED indicator)
- Red Fail (Red LED indicator)
- Dual Indication (Red LED indicator)
- Yellow/Clearance Failure (Red LED indicator)
- PCA/PC Ajar (Red LED indicator)
- Monitor Fail/Diagnostic Failure (Red LED indicator)
- 54 Channel Status Indicators (1 Red, 1 Yellow, and 1 Green LED indicator for each of the 18 channels)

Provide a switch to set the Red Fail fault timing. Ensure that when the switch is in the ON position the Red Fail fault timing value is set to 1350 +/- 150 ms (2018 mode). Ensure that when the switch is in the OFF position the Red Fail fault timing value is set to 850 +/- 150 ms (210 mode).

Provide a switch to set the Watchdog fault timing. Ensure that when the switch is in the ON position the Watchdog fault timing value is set to 1.0 +/- 0.1 s (2018 mode). Ensure that when the switch is in the OFF position the Watchdog fault timing value is set to 1.5 +/- 0.1 s (210 mode).

Provide a jumper or switch to set the AC line brown-out levels. Ensure that when the jumper is present or the switch is in the ON position the AC line dropout voltage threshold is 98 +/- 2 Vrms, the AC line restore voltage threshold is 103 +/- 2 Vrms, and the AC line brown-out timing value is set to 400 +/- 50ms (2018 mode). Ensure that when the jumper is not present or the switch is in the OFF position the AC line dropout voltage threshold is 92 +/- 2 Vrms, the AC line restore voltage threshold is 98 +/- 2 Vrms, and the AC line brown-out timing value is set to 80 +/- 17 ms (210 mode).

Provide a jumper or switch that will enable and disable the Watchdog Latch function. Ensure that when the jumper is not present or the switch is in the OFF position the Watchdog Latch function is disabled. In this mode of operation, a Watchdog fault will be reset following a power loss, brownout, or power interruption. Ensure that when the jumper is present or the switch is in the ON position the Watchdog Latch function is enabled. In this mode of operation, a Watchdog fault will be retained until a Reset command is issued.

Provide a jumper that will reverse the active polarity for pin #EE (output relay common). Ensure that when the jumper is not present pin #EE (output relay common) will be considered 'Active' at a voltage greater than 70 Vrms and 'Not Active' at a voltage less than 50 Vrms (Caltrans mode). Ensure that when the jumper is present pin #EE (output relay common) will be considered 'Active' at a voltage less than 50 Vrms and 'Not Active' at a voltage greater than 70 Vrms (Failsafe mode).

In addition to the connectors required by CALTRANS' 2009 TEES, provide the conflict monitor with a red interface connector mounted on the front of the monitor. Ensure the connector is a 20 pin, right angle, center polarized, male connector with latching clip locks and polarizing keys. Ensure the right angle solder tails are designed for a 0.062" thick printed circuit board. Keying of the connector shall be between pins 3 and 5, and between 17 and 19. Ensure the connector has two rows of pins with the odd numbered pins on one row and the even pins on the other row. Ensure the connector pin row spacing is 0.10" and pitch is 0.10". Ensure the mating length of the connector pins is 0.24". Ensure the pins are finished with gold plating 30μ" thick.

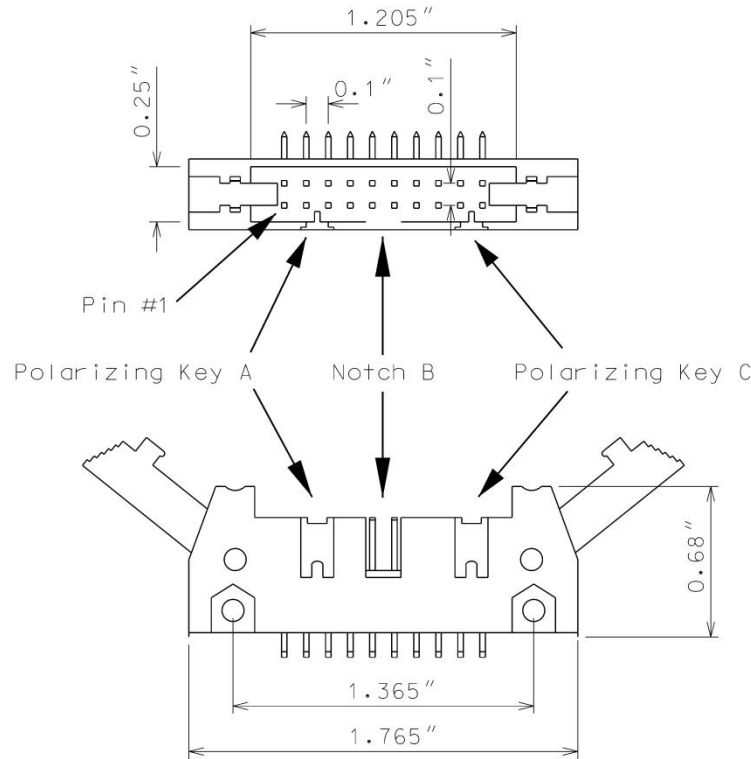

Ensure the red interface connector pins on the monitor have the following functions:

Pin #	Function	Pin #	Function
1	Channel 15 Red	2	Channel 16 Red
3	Channel 14 Red	4	Chassis Ground
5	Channel 13 Red	6	Special Function 2
7	Channel 12 Red	8	Special Function 1
9	Channel 10 Red	10	Channel 11 Red
11	Channel 9 Red	12	Channel 8 Red
13	Channel 7 Red	14	Channel 6 Red
15	Channel 5 Red	16	Channel 4 Red
17	Channel 3 Red	18	Channel 2 Red
19	Channel 1 Red	20	Red Enable

Ensure that removal of the P20 cable connector will cause the conflict monitor to recognize a latching fault condition and place the cabinet into flashing operation.

Provide Special Function 1 and Special Function 2 inputs to the unit which shall disable only Red Fail Monitoring when either input is sensed active. A Special Function input shall be sensed active when the input voltage exceeds 70 Vrms with a minimum duration of 550 ms. A Special Function input shall be sensed not active when the input voltage is less than 50 Vrms or the duration is less

than 250 ms. A Special Function input is undefined by these specifications and may or may not be sensed active when the input voltage is between 50 Vrms and 70 Vrms or the duration is between 250 ms and 550 ms.

Ensure the conflict monitor recognizes field signal inputs for each channel that meet the following requirements:

- consider a Red input greater than 70 Vrms and with a duration of at least 500 ms as an “on” condition;
- consider a Red input less than 50 Vrms or with a duration of less than 200 ms as an “off” condition (no valid signal);
- consider a Red input between 50 Vrms and 70 Vrms or with a duration between 200 ms and 500 ms to be undefined by these specifications;
- consider a Green or Yellow input greater than 25 Vrms and with a duration of at least 500 ms as an “on” condition;
- consider a Green or Yellow input less than 15 Vrms or with a duration of less than 200 ms as an “off” condition; and
- consider a Green or Yellow input between 15 Vrms and 25 Vrms or with a duration between 200 ms and 500 ms to be undefined by these specifications.

Provide a conflict monitor that recognizes the faults specified by CALTRANS’ 2009 TEES and the following additional faults. Ensure the conflict monitor will trigger upon detection of a fault and will remain in the triggered (in fault mode) state until the unit is reset at the front panel or through the external remote reset input for the following failures:

1. **Red Monitoring or Absence of Any Indication (Red Failure):** A condition in which no “on” voltage signal is detected on any of the green, yellow, or red inputs to a given monitor channel. If a signal is not detected on at least one input (R, Y, or G) of a conflict monitor channel for a period greater than 1000 ms when used with a 170 controller and 1500 ms when used with a 2070 controller, ensure monitor will trigger and put the intersection into flash. If the absence of any indication condition lasts less than 700 ms when used with a 170 controller and 1200 ms when used with a 2070 controller, ensure conflict monitor will not trigger. Red fail monitoring shall be enabled on a per channel basis by the use of switches located on the conflict monitor. Have red monitoring occur when all of the following input conditions are in effect:
 - a) Red Enable input to monitor is active (Red Enable voltages are “on” at greater than 70 Vrms, off at less than 50 Vrms, undefined between 50 and 70 Vrms), and
 - b) Neither Special Function 1 nor Special Function 2 inputs are active.
 - c) Pin #EE (output relay common) is not active
2. **Short/Missing Yellow Indication Fault (Clearance Error):** Yellow indication following a green is missing or shorter than 2.7 seconds (with ± 0.1 -second accuracy). If a channel fails to detect an “on” signal at the Yellow input for a minimum of 2.7 seconds (± 0.1 second) following the detection of an “on” signal at a Green input for that channel, ensure that the monitor triggers and generates a clearance/short yellow error fault indication. Short/missing

yellow (clearance) monitoring shall be enabled on a per channel basis by the use of switches located on the conflict monitor. This fault shall not occur when the channel is programmed for Yellow Inhibit, when the Red Enable signal is inactive or pin #EE (output relay common) is active.

3. **Dual Indications on the Same Channel:** In this condition, more than one indication (R,Y,G) is detected as “on” at the same time on the same channel. If dual indications are detected for a period greater than 500 ms, ensure that the conflict monitor triggers and displays the proper failure indication (Dual Ind fault). If this condition is detected for less than 200 ms, ensure that the monitor does not trigger. G-Y-R dual indication monitoring shall be enabled on a per channel basis by the use of switches located on the conflict monitor. G-Y dual indication monitoring shall be enabled for all channels by use of a switch located on the conflict monitor. This fault shall not occur when the Red Enable signal is inactive or pin #EE (output relay common) is active.
4. **Configuration Settings Change:** The configuration settings are comprised of (as a minimum) the permissive diode matrix, dual indication switches, yellow disable jumpers, any option switches, any option jumpers, and the Watchdog Enable switch. Ensure the conflict monitor compares the current configuration settings with the previous stored configuration settings on power-up, on reset, and periodically during operation. If any of the configuration settings are changed, ensure that the conflict monitor triggers and causes the program card indicator to flash. Ensure that configuration change faults are only reset by depressing and holding the front panel reset button for a minimum of three seconds. Ensure the external remote reset input does not reset configuration change faults.

Ensure the conflict monitor will trigger and the AC Power indicator will flash at a rate of $2 \text{ Hz} \pm 20\%$ with a 50% duty cycle when the AC Line voltage falls below the “drop-out” level. Ensure the conflict monitor will resume normal operation when the AC Line voltage returns above the “restore” level. Ensure the AC Power indicator will remain illuminated when the AC voltage returns above the “restore” level. Should an AC Line power interruption occur while the monitor is in the fault mode, then upon restoration of AC Line power, the monitor will remain in the fault mode and the correct fault and channel indicators will be displayed.

Provide a flash interval of at least 6 seconds and at most 16 seconds in duration following a power-up, an AC Line interruption, or a brownout restore. Ensure the conflict monitor will suspend all fault monitoring functions, close the Output relay contacts, and flash the AC indicator at a rate of $4 \text{ Hz} \pm 20\%$ with a 50% duty cycle during this interval. Ensure the termination of the flash interval after at least 6 seconds if the Watchdog input has made 5 transitions between the True and False state and the AC Line voltage is greater than the “restore” level. If the watchdog input has not made 5 transitions between the True and False state within 10 ± 0.5 seconds, the monitor shall enter a WDT error fault condition.

Ensure the conflict monitor will monitor an intersection with a minimum of four approaches using the four-section Flashing Yellow Arrow (FYA) vehicle traffic signal as outlined by the NCHRP 3-54 research project for protected-permissive left turn signal displays. Ensure the conflict monitor will operate in the FYA mode and FYAc (Compact) mode as specified below to monitor each channel pair for the following fault conditions: Conflict, Flash Rate Detection, Red Fail, Dual Indication, and

Clearance. Provide a switch to select between the FYA mode and FYAc mode. Provide a switch to select each FYA phase movement for monitoring.

FYA mode

FYA Signal Head	Phase 1	Phase 3	Phase 5	Phase 7
Red Arrow	Channel 9 Red	Channel 10 Red	Channel 11 Red	Channel 12 Red
Yellow Arrow	Channel 9 Yellow	Channel 10 Yellow	Channel 11 Yellow	Channel 12 Yellow
Flashing Yellow Arrow	Channel 9 Green	Channel 10 Green	Channel 11 Green	Channel 12 Green
Green Arrow	Channel 1 Green	Channel 3 Green	Channel 5 Green	Channel 7 Green

FYAc mode

FYA Signal Head	Phase 1	Phase 3	Phase 5	Phase 7
Red Arrow	Channel 1 Red	Channel 3 Red	Channel 5 Red	Channel 7 Red
Yellow Arrow	Channel 1 Yellow	Channel 3 Yellow	Channel 5 Yellow	Channel 7 Yellow
Flashing Yellow Arrow	Channel 1 Green	Channel 3 Green	Channel 5 Green	Channel 7 Green
Green Arrow	Channel 9 Green	Channel 9 Yellow	Channel 10 Green	Channel 10 Yellow

If a FYA channel pair is enabled for FYA operation, the conflict monitor will monitor the FYA logical channel pair for the additional following conditions:

1. **Conflict:** Channel conflicts are detected based on the permissive programming jumpers on the program card. This operation remains unchanged from normal operation except for the solid Yellow arrow (FYA clearance) signal.
2. **Yellow Change Interval Conflict:** During the Yellow change interval of the Permissive Turn channel (flashing Yellow arrow) the conflict monitor shall verify that no conflicting channels to the solid Yellow arrow channel (clearance) are active. These conflicting channels shall be determined by the program card compatibility programming of the Permissive Turn channel (flashing Yellow arrow). During the Yellow change interval of the Protected Turn channel (solid Green arrow) the conflict monitor shall verify that no conflicting channels to the solid Yellow arrow channel (clearance) are active as determined by the program card compatibility programming of the Protected Turn channel (solid Green arrow).

3. **Flash Rate Detection:** The conflict monitor unit shall monitor for the absence of a valid flash rate for the Permissive turn channel (flashing Yellow arrow). If the Permissive turn channel (flashing Yellow arrow) is active for a period greater than 1600 milliseconds, ensure the conflict monitor triggers and puts the intersection into flash. If the Permissive turn channel (flashing Yellow arrow) is active for a period less than 1400 milliseconds, ensure the conflict monitor does not trigger. Ensure the conflict monitor will remain in the triggered (in fault mode) state until the unit is reset at the front panel or through the external remote reset input. Provide a jumper or switch that will enable and disable the Flash Rate Detection function. Ensure that when the jumper is not present or the switch is in the OFF position the Flash Rate Detection function is enabled. Ensure that when the jumper is present or the switch is in the ON position the Flash Rate Detection function is disabled.
4. **Red Monitoring or Absence of Any Indication (Red Failure):** The conflict monitor unit shall detect a red failure if there is an absence of voltage on all four of the inputs of a FYA channel pair (RA, YA, FYA, GA).
5. **Dual Indications on the Same Channel:** The conflict monitor unit shall detect a dual indication if two or more inputs of a FYA channel pair (RA, YA, FYA, GA) are “on” at the same time.
6. **Short/Missing Yellow Indication Fault (Clearance Error):** The conflict monitor unit shall monitor the solid Yellow arrow for a clearance fault when terminating both the Protected Turn channel (solid Green arrow) interval and the Permissive Turn channel (flashing Yellow arrow) interval.

Ensure that the conflict monitor will log at least nine of the most recent events detected by the monitor in non-volatile EEPROM memory (or equivalent). For each event, record at a minimum the time, date, type of event, status of each field signal indication with RMS voltage, and specific channels involved with the event. Ensure the conflict monitor will log the following events: monitor reset, configuration, previous fault, and AC line. Furnish the signal sequence log that shows all channel states (Greens, Yellows, and Reds) and the Red Enable State for a minimum of 2 seconds prior to the current fault trigger point. Ensure the display resolution of the inputs for the signal sequence log is not greater than 50 ms.

For conflict monitors used within an Ethernet communications system, provide a conflict monitor with an Ethernet 10/100 Mbps, RJ-45 port for data communication access to the monitor by a local notebook computer and remotely via a workstation or notebook computer device connected to the signal system local area network. The Ethernet port shall be electrically isolated from the conflict monitor’s electronics and shall provide a minimum of 1500 Vrms isolation. Integrate monitor with Ethernet network in cabinet. Provide software to retrieve the time and date from a network server in order to synchronize the on-board times between the conflict monitor and the controller. Furnish and install the following Windows based, graphic user interface software on workstations and notebook computers where the signal system client software is installed: 1) software to view and retrieve all event log information, 2) software that will search and display a list of conflict monitor IP addresses and IDs on the network, and 3) software to change the conflict monitor’s network parameters such as IP address and subnet mask.

For non-Ethernet connected monitors, provide a RS-232C/D compliant port (DB-9 female connector) on the front panel of the conflict monitor in order to provide communications from the conflict monitor to the 170/2070 controller or to a Department-furnished laptop computer. Electrically isolate the port interface electronics from all monitor electronics, excluding Chassis Ground. Ensure that the controller can receive all event log information through a controller

U-4713A**TS-24****Mecklenburg County**

Asynchronous Communications Interface Adapter (Type 170E) or Async Serial Comm Module (2070). Furnish and connect a serial cable from the conflict monitor's DB-9 connector to Comm Port 1 of the 2070 controller. Ensure conflict monitor communicates with the controller. Provide a Windows based graphic user interface software to communicate directly through the same monitor RS-232C/D compliant port to retrieve and view all event log information to a Department-furnished laptop computer. The RS-232C/D compliant port on the monitor shall allow the monitor to function as a DCE device with pin connections as follows:

Conflict Monitor RS-232C/D (DB-9 Female) Pinout		
Pin Number	Function	I/O
1	DCD	O
2	TX Data	O
3	RX Data	I
4	DTR	I
5	Ground	-
6	DSR	O
7	CTS	I
8	RTS	O
9	NC	-

U-4713A

TS-25

Mecklenburg County

MONITOR BOARD EDGE CONNECTOR

Pin #	Function (Back Side)	Pin #	Function (Component Side)
1	Channel 2 Green	A	Channel 2 Yellow
2	Channel 13 Green	B	Channel 6 Green
3	Channel 6 Yellow	C	Channel 15 Green
4	Channel 4 Green	D	Channel 4 Yellow
5	Channel 14 Green	E	Channel 8 Green
6	Channel 8 Yellow	F	Channel 16 Green
7	Channel 5 Green	H	Channel 5 Yellow
8	Channel 13 Yellow	J	Channel 1 Green
9	Channel 1 Yellow	K	Channel 15 Yellow
10	Channel 7 Green	L	Channel 7 Yellow
11	Channel 14 Yellow	M	Channel 3 Green
12	Channel 3 Yellow	N	Channel 16 Yellow
13	Channel 9 Green	P	Channel 17 Yellow
14	Channel 17 Green	R	Channel 10 Green
15	Channel 11 Yellow	S	Channel 11 Green
16	Channel 9 Yellow	T	Channel 18 Yellow
17	Channel 18 Green	U	Channel 10 Yellow
--		--	
18	Channel 12 Yellow	V	Channel 12 Green
19	Channel 17 Red	W	Channel 18 Red
20	Chassis Ground	X	Not Assigned
21	AC-	Y	DC Common
22	Watchdog Timer	Z	External Test Reset
23	+24VDC	AA	+24VDC
24	Tied to Pin 25	BB	Stop Time (Output)
25	Tied to Pin 24	CC	Not Assigned
26	Not Assigned	DD	Not Assigned
27	Relay Output, Side #3, N.O.	EE	Relay Output, Side #2, Common
28	Relay Output, Side #1, N.C.	FF	AC+

-- Slotted for keying between Pins 17/U and 18/V

CONFLICT PROGRAM CARD PIN ASSIGNMENTS

Pin #	Function (Back Side)	Pin #	Function (Component Side)
1	Channel 2 Green	A	Channel 1 Green
2	Channel 3 Green	B	Channel 2 Green
3	Channel 4 Green	C	Channel 3 Green
4	Channel 5 Green	D	Channel 4 Green
5	Channel 6 Green	E	Channel 5 Green
6	Channel 7 Green	F	Channel 6 Green
7	Channel 8 Green	H	Channel 7 Green
8	Channel 9 Green	J	Channel 8 Green
9	Channel 10 Green	K	Channel 9 Green
10	Channel 11 Green	L	Channel 10 Green
11	Channel 12 Green	M	Channel 11 Green
12	Channel 13 Green	N	Channel 12 Green
13	Channel 14 Green	P	Channel 13 Green
14	Channel 15 Green	R	Channel 14 Green
15	Channel 16 Green	S	Channel 15 Green
16	N/C	T	PC AJAR
17	Channel 1 Yellow	U	Channel 9 Yellow
18	Channel 2 Yellow	V	Channel 10 Yellow
19	Channel 3 Yellow	W	Channel 11 Yellow
20	Channel 4 Yellow	X	Channel 12 Yellow
21	Channel 5 Yellow	Y	Channel 13 Yellow
22	Channel 6 Yellow	Z	Channel 14 Yellow
23	Channel 7 Yellow	AA	Channel 15 Yellow
24	Channel 8 Yellow	BB	Channel 16 Yellow
--		--	
25	Channel 17 Green	CC	Channel 17 Yellow
26	Channel 18 Green	DD	Channel 18 Yellow
27	Channel 16 Green	EE	PC AJAR (Program Card)
28	Yellow Inhibit Common	FF	Channel 17 Green

-- Slotted for keying between Pins 24/BB and 25/CC

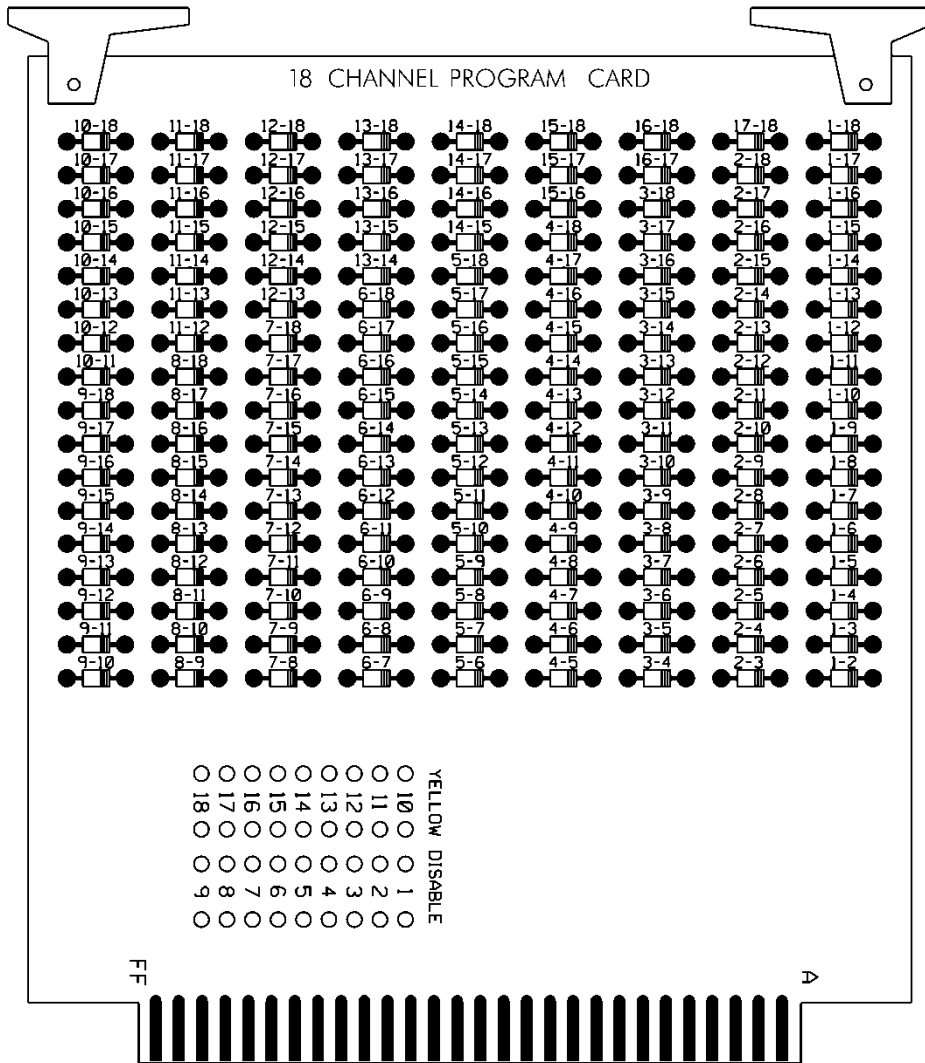

2.4. MATERIALS – TYPE 170 DETECTOR SENSOR UNITS

Furnish detector sensor units that comply with Chapter 5 Section 1, “General Requirements,” and Chapter 5 Section 2, “Model 222 & 224 Loop Detector Sensor Unit Requirements,” of the CALTRANS “Transportation Electrical Equipment Specifications” dated March 12, 2009 with Erratum 1.

3. VIDEO IMAGING LOOP EMULATOR DETECTOR SYSTEMS FOR TEMPORARY INSTALLATION

3.1.DESCRPTION

Design, furnish, provide training, and install video imaging loop emulator detection systems with all necessary hardware for temporary traffic signals in accordance with the plans and specifications.

Unless otherwise specified in the contract, all loop emulator detection equipment will remain the property of the contractor.

3.2.MATERIALS

A. General:

Material and equipment furnished under this section must be pre-approved on the Department's QPL by the date of installation except miscellaneous hardware such as cables and mounting hardware do not need to be pre-approved.

Used equipment will be acceptable provided the following conditions have been met:

- Equipment is listed on the current QPL.
- Equipment is in good working condition.
- Equipment is to remain the property of the contractor.

Ensure that software is licensed for use by the Department and by any other agency responsible for maintaining or operating the loop emulation system. Provide the Department with a license to duplicate and distribute the software as necessary for design and maintenance support.

Design and furnish video imaging loop emulator detection systems that detect vehicles at signalized intersections by processing video images and providing detection outputs to the signal controller in real time (within 112 milliseconds of vehicle arrival).

Furnish all required camera sensor units, loop emulator processor units, hardware and software packages, cabling, poles, mast arms, harnesses, camera mounting assemblies, surge protection panels, grounding systems, messenger cable and all necessary hardware. Furnish systems that allow the display of detection zones superimposed on an image of the roadway on a Department-furnished monitor or laptop computer screen. Ensure detection zones can be defined and data entered using a simple keyboard or mouse and monitor, or using a laptop PC with software.

Provide design drawings showing design details and camera sensor unit locations for review and acceptance before installation. Provide mounting height and location requirements for camera sensor units on the design based on site survey. Design video imaging loop emulator detection systems with all necessary hardware. Indicate all necessary poles, spans, mast arms, luminaire arms, cables, camera mounting assemblies and hardware to achieve the required detection zones where Department owned poles are not adequate to locate the camera sensor units. Do not design for the installation of poles in medians.

Obtain the Engineer's approval before furnishing video imaging loop emulator detection systems. The contractor is responsible for the final design of video imaging loop emulator detection systems. Review and acceptance of the designs by the Department does not relieve the contractor from the responsibility to provide fully functional systems and to ensure that the required detection zones can be provided.

Provide the ability to program each detection call (input to the controller) with the following functions:

- Full Time Delay – Delay timer is active continuously,
- Normal Delay – Delay timer is inhibited when assigned phase is green (except when used with TS 2 and 170/2070L controllers),
- Extend – Call is extended for this amount of time after vehicle leaves detection area,
- Delay Call/Extend Call – This feature uses a combination of full time delay and extend time on the same detection call. Ensure operation is as follows: Vehicle calls are received after the delay timer times out. When a call is detected, it is held until the detection area is empty and the programmed extend time expires. If another vehicle enters the detection area before the

extend timer times out, the call is held and the extend time is reset. When the extend timer times out, the delay timer has to expire before another vehicle call can be received.

Provide the ability to program each detection zone as one of the following functions:

- Presence detector,
- Directional presence detector,
- Pulse detector,
- Directional pulse detector.

Ensure previously defined detector zones and configurations can be edited.

Provide each individual system with all the necessary equipment to focus and zoom the camera lenses without the need to enter the camera enclosure.

Provide systems that allow for the placement of at least 8 detection zones within the combined field of view of a single camera sensor unit. Provide a minimum of 8 detection outputs per camera.

Provide detection zones that can be overlapped. Ensure systems reliably detect vehicles when the horizontal distance from the camera sensor unit to the detection zone area is less than ten times the mounting height of the sensor. Ensure systems detect vehicles in multiple travel lanes.

Ensure systems can detect vehicle presence within a 98 to 102 percent accuracy (up to 2 percent of the vehicles missed and up to 2 percent of false detection) for clear, dry, daylight conditions, a 96 to 105 percent accuracy (up to 4 percent of the vehicles missed and up to 5 percent false detection) for dawn and dusk conditions, and a 96 percent accuracy (up to 4 percent of the vehicles missed) for night and adverse conditions (fog, snow, rain, etc.) using standard sensor optics and in the absence of occlusion.

Repair and replace all failed components within 72 hours.

The Department may conduct field-testing to ensure the accuracy of completed video imaging loop emulator detection systems.

B. Loop Emulator System:

Furnish loop emulator systems that receive and simultaneously process information from camera sensor units, and provides detector outputs to signal controllers.

Ensure systems provide the following:

- Operate in a typical roadside environment and meet the environmental specifications and are fully compatible with NEMA TS 1, NEMA TS 2, or Type 170/2070L controllers and cabinets,
- provide a “fail-safe” mode whereby failure of one or more of the camera sensor units or power failure of the loop emulator system will cause constant calls to be placed on the affected vehicle detection outputs to the signal controller,
- provide compensation for minor camera movement of up to 2 percent of the field of view at 400 feet without falsely detecting vehicles,
- process the video at a minimum rate of 30 times per second,
- provide separate wired connectors inside the controller cabinet for video recording each camera,
- provide remote video monitoring with a minimum refresh rate at 1 frame per second over a standard dial-up telephone line,
- provide remote video detection monitoring.

Furnish camera sensor units that comply with the following:

- have an output signal conforming to EIA RS-170 standard,
- have a nominal output impedance of 75 ohms,
- be immune to bright light sources, or have built in circuitry or protective devices to prevent damage to the sensor when pointed directly at strong light sources,
- be housed in a light colored environmental enclosure that is water proof and dust tight, and that conforms to NEMA-4 specifications or better,
- simultaneously monitor at least five travel lanes when placed at the proper mounting location with a zoom lens,
- have a sunshield attached to the environmental enclosure to minimize solar heating,
- meet FCC class B requirements for electromagnetic interference emissions,
- have a heater attached to the viewing window of the environmental enclosure to prevent ice and condensation in cold weather.

Where coaxial video cables and other cables are required between the camera sensor and other components located in the controller cabinet, furnish surge protection in the controller cabinet.

If furnishing coaxial communications cable comply with the following, as recommended by the approved loop emulator manufacturer:

- Number 20 AWG, solid bare copper conductor terminated with crimped-on BNC connectors (do not use BNC adapters) from the camera sensor to the signal controller cabinet.
- Number 22 AWG, stranded bare copper conductor terminated with crimped-on BNC connectors (do not use BNC adapters) from the camera sensor unit to the junction box, and within the signal controller cabinet.

Furnish power cable appropriately sized to meet the power requirements of the sensors. At a minimum, provide three conductor 120 VAC field power cable.

As determined during the site survey, furnish sensor junction boxes with nominal 6 x 10 x 6 inches dimensions at each sensor location. Provide terminal blocks and tie points for coaxial cable.

C. Video Imaging Loop Emulator System Support:

Furnish video imaging loop emulator systems with either a simple keyboard or a mouse with monitor and appropriate software, or with system software for use on department-owned laptop PCs. Ensure the system is Windows 2000 and Windows XP compatible.

Provide Windows 2000 and Windows XP compatible personal computer software, if needed, to provide remote video and video detection monitoring.

Ensure systems allow the user to edit previously defined detector configurations. When a vehicle is within a detection zone, provide for a change in color or intensity of the detection zone perimeter or other appropriate display changes on the Department-furnished monitor or laptop computer screen.

Provide cabling and interconnection hardware with 6-foot minimum length interconnection cable to interface with the system.

Provide all associated equipment manuals and documentation.

3.3.CONSTRUCTION METHODS

Arrange and conduct site surveys with the system manufacturer's representative and Department personnel to determine proper camera sensor unit selection and placement. Provide the Department

at least 3 working days notice before conducting site surveys. Upon completion of the site surveys the Department will provide revised plans reflecting the findings of the site survey.

Before beginning work at locations requiring video imaging loop emulator detection systems, furnish system software. Upon activation of detection zones, provide detector configuration files. Ensure that up-to-date detection configuration files are furnished for various detection zone configurations that may be required for construction phasing.

Place into operation loop emulator detection systems. Configure loop emulator detection systems to achieve required detection in designated zones. Have a certified manufacturer’s representative on site to supervise and assist with installation, set up, and testing of the system.

Install the necessary processing and communications equipment in the signal controller cabinet. Make all necessary modifications to install equipment, cabling harnesses, and camera sensor interface panels with surge suppression.

Perform modifications to camera sensor unit gain, sensitivity, and iris limits necessary to complete the installation.

Do not install camera sensor units on signal poles unless approved by the Engineer.

Install the necessary cables from each sensor to the signal controller cabinet along signal cabling routes. Install surge protection and terminate all cable conductors.

Relocate camera sensor units and reconfigure detection zones as necessary according to the plans for construction phases.

Provide at least 8 hours of training on the set up, operation, troubleshooting, and maintenance of the loop emulator detection system to a maximum of ten Department personnel. Arrange for training to be conducted by the manufacturer’s representative at an approved site within the Division responsible for administration of the project. Thirty days before conducting training submit a detailed course curriculum, draft manuals and materials, and resumes. Obtain approval of the submittal before conducting the training. At least one week before beginning training, provide three sets of complete documentation necessary to maintain and operate the system. Do not perform training until installation of loop emulator detection systems is complete.

3.4. MEASUREMENT AND PAYMENT

Actual number of site surveys, arranged, conducted, and accepted.

Actual number of cameras with internal loop emulator processing units furnished, installed, and accepted.

Actual number of temporary camera sensor units relocated with detection zones reconfigured installed, and accepted.

No measurement will be made of video imaging loop emulator system support or training, power and video cables, and trenching as these items will be considered incidental to furnishing and installing video imaging loop emulator detection systems.

Payment will be made under:

Site Survey.....	Each
Camera with Internal Loop Emulator Processing Unit.....	Each
Relocate Temporary Camera Sensor Unit.....	Each

4. METAL POLE SUPPORTS

4.1. METAL POLES

A. General:

Furnish and install metal poles, grounding systems, and all necessary hardware. Work covered under this special provision includes requirements for design, fabrication, and installation of standard and custom/site-specific designed metal pole supports and associated foundations.

Comply with applicable sections of the *2024 STANDARD SPECIFICATIONS FOR ROADS & STRUCTURES*, hereinafter referred to as the *Standard Specifications*. Provide designs of completed assemblies with hardware equaling or exceeding *AASHTO LRFD Specifications for Structural Supports for Highway Signs, Luminaires and Traffic Signals* 1st Edition, 2015 (hereinafter called 1st Edition AASHTO), including the latest interim specifications. Provide assemblies with a round or near-round (18 sides or more) cross-section, or a multi-sided cross section with no less than six sides. The sides may be straight, convex, or concave.

For bid purposes, pole heights shown on plans are estimated from available data. Prior to furnishing metal poles, use field measurements and adjusted cross-sections to determine whether pole heights will meet required clearances. If pole heights do not meet required clearances, the Contractor should immediately notify the Engineer of the required revised pole heights.

Standard Drawings for Metal Poles are available that supplement these project special provisions. The drawings are located on the Department’s website:

<https://connect.ncdot.gov/resources/safety/pages/ITS-Design-Resources.aspx>

Comply with article 1098-1(B) of the *Standard Specifications* for submittal requirements. Furnish shop drawings for approval. Provide copies of detailed shop drawings for each type of structure as summarized below. Ensure shop drawings include material specifications for each component. Ensure shop drawings identify welds by type and size on the detail drawing only, not in table format. **Do not release structures for fabrication until shop drawings have been approved by NCDOT.** Ensure shop drawings contain an itemized bill of materials for all structural components and associated connecting hardware.

Comply with article 1098-1(A) of the *Standard Specifications* for Qualified Products List (QPL) submittals. All shop drawings must include project location description, signal or asset inventory number(s) and project number or work order number.

Summary of information required for metal pole review submittal:

Item	Electronic Submittal	Comments / Special Instructions
Sealed, Approved Signal or ITS Plan/Loading Diagram	1 set	All structure design information needs to reflect the latest approved Signal or ITS plans
Custom Pole Shop Drawings	1 set	Submit drawings on 11” x 17” format media. Show NCDOT signal or asset inventory number(s), Contractor’s name and relevant revision number in the title block. All drawings must have a <u>unique drawing number</u> for each project.

Standard Strain Pole Shop Drawings (from the QPL)	1 set	Submit drawings on 11" x 17" format media. Show NCDOT signal inventory number(s), Contractor's name and relevant revision number in the title block. All drawings must have a <u>unique drawing number</u> for each project.
Structure Calculations	1 set	Not required for Standard QPL Poles
Standard Strain Pole Foundation Drawings	1 set	Submit drawings on 11" x 17" format media. Submit a completed Standard Foundation Selection form for each pole using foundation table on Metal Pole Drawing M8.
Custom Foundation Drawings	1 set	Submit drawings on 11" x 17" format media. Show NCDOT signal or asset inventory number(s), Contractor's name and relevant revision number in the title block. All drawings must have a <u>unique drawing number</u> for each project. If QPL Poles are used, include the corresponding QPL pole shop drawings with this submittal.
Foundation Calculations	1 set	Submit copies of LPILE input, output, and pile tip deflection graph per Section titled Drilled Pier Foundations for Metal Poles of this specification for each foundation. Not required for Standard Strain Poles (from the QPL)
Soil Boring Logs and Report	1 set	Report shall include a location plan and a soil classification report including soil capacity, water level, hammer efficiency, soil bearing pressure, soil density, etc. for each pole.

NOTE – All shop drawings and custom foundation design drawings must be sealed by a Professional Engineer licensed in the state of North Carolina. All geotechnical information must be sealed by either a Professional Engineer or Geologist licensed in the state of North Carolina. Include a title block and revision block on the shop drawings and foundation drawings showing the NCDOT signal or asset inventory number(s).

Shop drawings and foundation drawings may be submitted together or separately for approval. However, shop drawings must be approved before foundations can be reviewed. Foundation designs will be returned without review if the associated shop drawing has not been approved. Boring reports shall include the following: Engineer's summary, boring location maps, soil classification per AASHTO Classification System, hammer efficiency, and Metal Pole Standard Foundation Selection Form. Incomplete submittals will be returned without review. The Reviewer has the right to request additional analysis and copies of the calculations to expedite the approval process.

B. Materials:

Fabricate metal pole from coil or plate steel that meet the requirements of ASTM A 572 Gr 55 or ASTM A 595 Grade A tubes. For structural steel shapes, plates, and bars use, as a minimum, ASTM A572 Gr 50, AASHTO M270 Gr 50, ASTM A709 Gr 50, or an approved equivalent. Provide pole shafts of round or near round (18 sides or more) cross-section, or multi-sided tubular cross-section

with no less than six sides, having a uniform linear taper of 0.14 in/ft. Construct shafts from one piece of single-ply plate or coil. For anchor base fabrication, conform to the applicable bolt pattern and orientation as shown on Metal Pole Standard Drawing Sheet M2.

Use the submerged arc process, or other NCDOT previously approved process suitable for shafts, to continuously weld pole shafts along their entire length. Finish the longitudinal seam weld flush with the outside contour of the base metal. Ensure shaft has no circumferential welds except at the lower end joining the shaft to the pole base. Use full penetration groove welds with backing ring for all tube-to-transverse-plate connections in accordance with 1st Edition AASHTO. Provide welding that conforms to Article 1072-18 of the *Standard Specifications*. No field welding on any part of the pole will be permitted unless approved by a qualified Engineer.

After fabrication, hot-dip galvanize steel poles and all assembly components in accordance with section 1076-3 of the *Standard Specifications*. Design structural assemblies with weep holes large enough and properly located to drain molten zinc during the galvanization process. Galvanize hardware in accordance with section 1076-4 of the *Standard Specifications*. Ensure threaded material is brushed and retapped as necessary after galvanizing. Perform repair of damaged galvanizing in accordance with section 1076-7 of the *Standard Specifications*. Ensure all hardware is galvanized steel or stainless steel. The Contractor is responsible for ensuring the Designer/Fabricator specifies connecting hardware and/or materials that prevent a dissimilar metal corrosive reaction.

Ensure each anchor rod is 2-inch minimum diameter and 60-inch length. Provide 10-inch minimum thread projection at the top of the rod, and 8-inch minimum at the bottom of the rod. Use anchor rod assembly and drilled pier foundation materials complying with SP09_R005, hereinafter referred to as *Foundations and Anchor Rod Assemblies for Metal Poles*.

Ensure anchor bolt hole diameters are 1/4-inch larger than the anchor bolt diameters in the base plate.

Provide a circular anchor bolt lock plate securing the anchor bolts at the embedded end with two (2) washers and two (2) nuts. Provide a base plate template matching the bolt circle diameter of the anchor bolt lock plate. Construct plates and templates from 1/4-inch minimum thick steel with a minimum width of 4 inches. Hot-dip galvanizing is not required for both plates.

Provide four (4) heavy hex nuts and four (4) flat washers for each anchor bolt. For nuts, use AASHTO M291 grade 2H, DH, or DH3 or equivalent material. For flat washers, use AASHTO M293 or equivalent material. Ensure anchor bolts have required diameters, lengths, and positions, and will develop strengths comparable to their respective poles.

For each pole, provide a grounding lug with a 1/2-inch minimum thread diameter, coarse thread stud and nut that will accommodate #4 AWG ground wire. Ensure the lug is electrically bonded to the pole and is conveniently located inside the pole at the hand hole.

Provide a removable pole cap with stainless steel attachment screws for the top of each pole. Ensure cap is cast aluminum conforming to Aluminum Association Alloy 356.0F. Furnish cap attached to the pole with a sturdy stainless-steel chain that is long enough to permit cap to hang clear of the pole-top opening when cap is removed.

Where required by the plans, furnish couplings 42 inches above bottom of the pole base for mounting of pedestrian pushbuttons. Provide mounting points consisting of 1 1/2-inch internally threaded half-couplings complying with the NEC, mounted within the poles. Ensure that couplings are essentially flush with the outside surfaces of the poles and are installed before any required hot-dip galvanizing. Provide a threaded plug in each mounting point. Ensure the surface of the plug is

essentially flush with the outer end of the mounting point when installed and has a recessed slot that will accommodate a ½ “drive standard socket wrench.

Metal poles may be erected and fully loaded after concrete has attained a minimum allowable compressive strength of 3,000 psi.

Connect poles to grounding electrodes and bond them to the electrical service grounding electrodes.

When field drilling is necessary for wire or cable entrances into the pole, comply with the following requirements:

- Do not drill holes within 2 inches of any welds.
- Do not drill any holes larger than 3 inches in diameter without checking with the ITS & Signals Structure Engineers.
- Avoid drilling multiple holes along the same cross section of tube shafts.
- Install rubber grommets in all field drilled holes that wire, or cable will directly enter unless holes are drilled for installation of weather heads or couplings.
- Treat the inside of the drilled holes and repair all galvanized surfaces in accordance with Section 1076-7 of the latest edition of the *Standard Specification prior to installing grommets, caps, or plugs*.
- Cap or plug any existing field drilled holes that are no longer used with rubber, aluminum, or stainless-steel hole plugs.

When street lighting is installed on metal signal structures, isolate the conductors feeding the luminaires inside the pole shaft using liquid tight flexible metal conduit (Type LFMC), liquid tight flexible nonmetallic conduit (Type LFNC), high density polyethylene conduit (Type HDPE), or approved equivalent. All conductors supplying power for luminaires must run through an external disconnect prior to entrance into the structure. In accordance with the National Electrical Code (NEC) Article 230.2(E), provide identification of the electrical source provider for the luminaire feeder circuit with contact information on a permanent label located in the pole hand hole near the feeder circuit raceway.

Install a ¼-inch thick plate for a concrete foundation tag to include the following information: concrete grade, depth, diameter, and reinforcement sizes of the installed foundation. Install galvanized wire mesh to cover gap between the base plate and top of foundation for debris and pest control. Refer to standard drawing M7 for further details.

Immediately notify the Engineer of any structural deficiency that becomes apparent in any assembly, or member of any assembly, because of the design requirements imposed by these specifications, the plans, or the typical drawings.

C. Design:

Unless otherwise specified, design all metal pole support structures using the following 1st Edition AASHTO specifications:

- Use 700-Year MRI and 10-Year MRI wind pressure maps developed from 3-second gust speeds, as provided in Section 3.8.
- Ensure metal pole support structures include natural wind gust loading and truck-induced gust loading for fatigue design, as provided in Sections 11.7.1.2 and 11.7.1.3, respectively. Designs need not consider periodic galloping forces.

- Assume 11.2 mph natural wind gust speed in North Carolina. For natural wind fatigue stress calculations, utilize a drag coefficient (C_d) based on the yearly mean wind velocity of 11.2 mph.
- When selecting Fatigue Importance Factors, utilize Fatigue Importance Category II, as provided for in Table 11.6-1, unless otherwise specified.
- Calculate all forces using applicable equations from Section 5. The Maximum allowable force ratio for all metal pole support designs is 0.9.
- Conform to Sections 10.4.2 and 11.8 for deflection requirements. For CCTV and MVD support structures, ensure maximum deflection at top of pole does not exceed 2.0 percent of pole height.
- Assume the combined minimum weight of a messenger cable bundle (including messenger cable, signal cable and detector lead-in cables) is 1.3 lbs/ft. Assume the combined minimum diameter of the cable bundle is 1.3 inches.
- All CCTV and MVD poles shall meet the compact section limits per section 5.7.2 along with Table 5.7.2-1. Minimum thickness of CCTV and MVD pole shafts shall be ¼-inch.
- All CCTV and MVD poles shall use full-penetration groove weld tube-to-transverse plate connection with backing ring. Refer to Metal Pole Standard Drawing Sheet M9 for details. Fillet-welded tube-to-transverse-plate connections are not permitted.

Unless otherwise specified by special loading criteria, the following computed surface area for ice load on signal heads shall be used:

- 3-section, 12-inch, Surface area: 26.0 ft²
- 4-section, 12-inch, Surface area: 32.0 ft²
- 5-section, 12-inch, Surface area: 42.0 ft²

Design a base plate for each pole. The minimum base plate thickness for all poles is determined by the following criteria:

Case 1 Circular or rectangular solid base plate with the upright pole welded to the top surface of base plate with full penetration butt weld, where no stiffeners are provided. A base plate with a small center hole, which is less than 1/3 of the upright diameter, and located concentrically with the upright pole, may be considered as a solid base plate.

The magnitude of bending moment in the base plate, induced by the anchoring force of each anchor bolt is $M = (P \times D_1) / 2$, where

M = bending moment at the critical section of the base plate induced by one (1) anchor bolt

P = anchoring force of each anchor bolt

D_1 = horizontal distance between the anchor bolt center and the outer face of the upright, or the difference between the bolt circle radius and the outside radius of the upright

Locate the critical section at the face of the anchor bolt and perpendicular to the bolt circle radius. The overlapped part of two (2) adjacent critical sections is considered ineffective.

Case 2 Circular or rectangular base plate with the upright pole socketed into and attached to the base plate with two (2) lines of fillet weld, and where no stiffeners are provided, or any base plate with a center hole that is larger in diameter than 1/3 of the upright diameter.

The magnitude of bending moment induced by the anchoring force of each anchor bolt is $M = P \times D_2$,

where P = anchoring force of each anchor bolt

D_2 = horizontal distance between the face of the upright and the face of the anchor bolt nut

Locate the critical section at the face of the anchor bolt top nut and perpendicular to the radius of the bolt circle. The overlapped part of two (2) adjacent critical sections is considered ineffective. If the base plate thickness calculated for Case 2 is less than Case 1, use the thickness calculated for Case 1.

The following additional requirements apply concerning pole base plates.

- Ensure that whichever case governs as defined above, the anchor bolt diameter is set to match the base plate thickness. If the minimum diameter required for the anchor bolt exceeds the thickness required for the base plate, set the base plate thickness equal to the required bolt diameter.
- For all metal poles, use a full penetration groove weld with a backing ring to connect the pole upright component to the base. Refer to Metal Pole Standard Drawing Sheet M3 or M4.

The Professional Engineer is wholly responsible for the design of all poles. Review and acceptance of these designs by the Department does not relieve the said Professional Engineer of his or her responsibility.

D. Strain Poles:

Refer to Metal Pole Standard Drawing Sheets M2 and M3 for fabrication details.

Provide two (2) messenger cable (span wire) clamps and associated hardware for attachment of messenger cable. Ensure diameter of the clamp is appropriate to its location on the pole and is appropriately designed for adjustment from 1'-6" below the top, down to 6'-6" below the top of the pole. Do not attach more than one (1) support cable to a messenger cable clamp.

Provide a minimum of three (3) 2-inch holes equipped with an associated coupling and weatherhead on the messenger cable load side of the pole to accommodate passage of signal cables from inside the pole. Provide galvanized threaded plugs for all unused couplings at pole entrance points. Refer to Metal Pole Standard Drawing Sheet M3 for fabrication details.

Provide designs with a 6" x 12" hand hole with reinforcing frame for each pole.

Provide a terminal compartment with cover and screws in each pole encompassing the hand hole and containing a 12-terminal barrier type terminal block. Provide two (2) terminal screws with a removable shorting bar between them for each termination. Furnish terminal compartment covers attached to the pole by a sturdy chain or cable approved by the Engineer. Ensure chain or cable is long enough to permit cover to hang clear of the compartment opening when cover is removed and is strong enough to prevent vandalism. Ensure chain or cable will not interfere with service to cables in the pole base.

Have poles permanently stamped above the hand holes with the identification tag details as shown on Metal Pole Standard Drawing Sheets M2 and M3.

Provide grounding lug(s) in the approximate vicinity of the messenger cable clamp for bonding and grounding messenger cable. Lugs must accept #4 AWG wire to bond messenger cables to the pole in order to provide an effective ground fault circuit path. Refer to Metal Pole Standard Drawing Sheet M6 for construction details.

Install metal poles, hardware, and fittings as shown on the manufacturer's installation drawings. Ensure the installed pole, when fully loaded, is within 1 degree 40 minutes ($1^{\circ}40'$) of vertical. Install poles with the manufacturer's recommended "rake." Where required, use threaded leveling nuts to establish rake.

4.2. DRILLED PIER FOUNDATIONS FOR METAL POLES

Analysis procedures and formulas shall be based on AASHTO 1st Edition, latest ACI-318 code and the *Drilled Shafts: Construction Procedures and Design Methods* FHWA-NHI-10-016 manual. Design methods based on engineering publications or research papers must have prior approval from NCDOT. The Department reserves the right to accept or reject any method used for the analysis.

Ensure deflection at top of foundation does not exceed 1 inch for worst-case (Service Limit State) lateral load.

Use LPILE Plus V6.0 or later for lateral analysis. Submit inputs, results and corresponding graphs with the design calculations.

Calculate skin friction using the α -method for cohesive soils and the β -method for cohesion-less soils (**Broms method will not be accepted**). Detailed descriptions of the " α " and " β " methods can be found in *FHWA-NHI-10-016*.

Omit first 2.5 feet for cohesive soils when calculating skin friction.

Assume a hammer efficiency of 0.70 unless value is provided.

All CCTV and MVD pole drilled shafts shall be a minimum of 4'-0" diameter. Refer to Standard Drawing Nos. M7 and M8.

Design custom foundations to carry maximum capacity of each metal pole. For standard case strain poles with custom design, use actual shear, axial and moment reactions from the Standard Strain Pole Foundation Selection Table shown on Standard Drawing No. M8.

When poor soil conditions are encountered, which could create an excessively large foundation design, consideration may be given to allow an exemption to the maximum capacity design. The Contractor must gain approval from the Engineer before reducing a foundation's capacity. On projects where poor soil is known to be present, the Contractor should have foundation designs approved before releasing poles for fabrication.

Have the Contractor notify the Engineer if the proposed foundation is to be installed on a slope other than 8H: 1V or flatter.

A. Description:

Furnish and install foundations for NCDOT metal poles with all necessary hardware in accordance with the plans and specifications.

Metal Pole Standards have been developed and implemented by NCDOT for use at signalized intersections in North Carolina. If the plans call for a standard strain pole, then a standard foundation may be selected from the plans. However, the Contractor is not required to use a standard foundation. If the Contractor chooses to design a non-standard site-specific foundation for a standard strain pole or if the plans call for a non-standard site-specific pole, design the foundation to conform to the applicable provisions in the NCDOT Metal Pole Standard Drawings and Section B4 (Non-Standard Foundation Design) below. If non-standard site-specific foundations are designed for standard QPL approved strain poles, the foundation designer must use the design moment specified by load case on Metal Pole Standard Drawing Sheet M8. Failure to conform to this requirement will be grounds for rejection of the design.

If the Contractor chooses to design a non-standard foundation for a standard strain pole and the soil test results indicate a standard foundation is feasible for the site, the Contractor will be paid the cost of the standard foundation. Any additional cost associated with a non-standard site-specific foundation including additional materials, labor and equipment will be considered incidental to the cost of the standard foundation. All costs for the non-standard foundation design will be considered incidental to the cost of the standard foundation.

B. Soil Test and Foundation Determination:

1. General:

Drilled piers are reinforced concrete sections, cast-in-place against in situ, undisturbed material. Drilled piers are of straight shaft type and vertical.

2. Soil Test:

Perform a soil test at each proposed metal pole location. Complete all required fill placement and excavation at each pole location to finished grade before drilling each boring. Soil tests performed that are not in compliance with this requirement may be rejected and will not be paid. Drill one boring to a depth of 26 feet within a 25-foot radius of each proposed foundation.

Perform standard penetration tests (SPT) in accordance with ASTM D 1586 at depths of 1, 2.5, 5, 7.5, 10, 15, 20 and 26 feet. Discontinue the boring if one of the following occurs:

- A total of 100 blows have been applied in any two consecutive 6-inch intervals.
- A total of 50 blows have been applied with < 3-inch penetration.

Describe each pole location along the project corridor in a manner that is easily discernible to both the Contractor’s Designer and NCDOT Reviewers. If the pole is at an intersection, label the boring the “Intersection of (Route or SR #), (Street Name) and (Route or SR #), (Street Name), _____ County, Signal or Asset Inventory No. _____”. Label borings with “B- N, S, E, W, NE, NW, SE or SW” corresponding to the quadrant location within the intersection.

If the pole location is located between intersections, provide a coordinate location and offset, or milepost number and offset. Pole numbers should be made available to the Drill Contractor. Include pole numbers in the boring label if they are available. If they are not available, ensure the boring labels can be cross-referenced to corresponding pole numbers. For each boring, submit a legible (hand-written or typed) boring log signed and sealed by a licensed Geologist or Professional Engineer registered in North Carolina. Include on each boring the SPT blow counts and N-values at each depth, depth of the boring, hammer efficiency, depth of water table and a general description of the soil types encountered using the AASHTO Classification System.

Borings that cannot be easily correlated to their specific pole location will be returned to the Contractor for clarification; or if approved by the Engineer, the foundation may be designed using the worst-case soil condition obtained as part of this project.

3. Standard Foundation Determination:

Use the following method for determining the Design N-value:

$$N_{AVG} = \frac{N_{@1'} + N_{@2.5'} + \dots + N_{@Deepest\ Boring\ Depth}}{Total\ Number\ of\ N\ values}$$

$$Y = (N_{@1'})^2 + (N_{@2.5'})^2 + \dots + (N_{@Deepest\ Boring\ Depth})^2$$

$$Z = N_{@1'} + N_{@2.5'} + \dots + N_{@Deepest\ Boring\ Depth}$$

$$N_{STD\ DEV} = \sqrt{\left(\frac{(Total\ Number\ of\ N\ values \times Y) - Z^2}{(Total\ Number\ of\ N\ values) \times (Total\ Number\ of\ N\ values - 1)} \right)}$$

Design N-value equals lesser of the following two conditions:

$$N_{AVG} - (N_{STD\ DEV} \times 0.45)$$

OR

$$Average\ of\ First\ Four\ (4)\ N\ values = \frac{N_{@1'} + N_{@2.5'} + N_{@5'} + N_{@7.5'}}{4}$$

Note: If less than four (4) N-values are obtained because of criteria listed in Section 2 above, use average of N-values collected for second condition. Do not include the N-value at the deepest boring depth for above calculations if the boring is discontinued at or before the required boring depth because of criteria listed in Section 2 above. Use N-value of zero (0) for weight of hammer or weight of rod. If N-value is greater than fifty (50), reduce N-value to fifty (50) for calculations.

If standard NCDOT strain poles are shown on the plans and the Contractor chooses to use standard foundations, determine a drilled pier length, “L,” for each signal pole from the Standard Strain Pole Foundations Chart (sheet M8) based on the Design N-value and the predominant soil type. For each standard pole location, submit a completed “Metal Pole Standard Foundation Selection Form” signed by the Contractor’s representative. Signature on form is for verification purposes only. Include the Design N-value calculation and resulting drilled pier length, “L,” on each form.

If non-standard site-specific poles are shown on the plans, submit completed boring logs collected in accordance with Section 2 (Soil Test) along with pole loading diagrams from the plans to the Contractor-selected pole Fabricator to assist in the pole and foundation design.

If one of the following occurs, the Standard Foundations Chart shown on the plans may not be used and a non-standard foundation may be required. In such case, contact the Engineer.

- The Design N-value is less than four (4).
- The drilled pier length, “L”, determined from the Standard Foundations Chart, is greater than the depth of the corresponding boring.

In the case where a standard foundation cannot be used, the Department will be responsible for the additional cost of the non-standard foundation.

Foundation designs are based on level ground around the traffic signal pole. If the slope around the edge of the drilled pier is steeper than 8:1 (H:V) or the proposed foundation will be less than 10 feet from the top of an embankment slope, the Contractor is responsible for providing slope information to the foundation Designer and to the Engineer so it can be considered in the design.

The “Metal Pole Standard Foundation Selection Form” may be found at:

<https://connect.ncdot.gov/resources/safety/Pages/ITS-Design-Resources.aspx>

If assistance is needed, contact the Engineer.

4. Non-Standard Foundation Design:

Design non-standard foundations based upon site-specific soil test information collected in accordance with Section 2 (Soil Test). Design drilled piers for side resistance in accordance with Section 10.8 of the 2014 AASHTO LRFD Bridge Design Specifications, 7th Edition. Use computer software LPILE version-6.0 or later manufactured by Ensoft, Inc. to analyze drilled piers. Use computer software gINT V8i or later manufactured by Bentley Systems, Inc. with the current NCDOT gINT library and data template to produce SPT boring logs. Provide a drilled pier foundation for each pole with a length and diameter resulting in horizontal lateral movement less than 1 inch at top of the pier, and horizontal rotational movement less than 1 inch at the edge of pier. Contact the Engineer for pole loading diagrams of standard poles used for non-standard foundation designs. Submit non-standard foundation designs including drawings, calculations, and soil boring logs to the Engineer for review and approval before construction.

C. Drilled Pier Construction:

Construct drilled pier foundation and Install anchor rod assemblies in accordance with the Foundations and Anchor Rod Assemblies for Metal Poles Standard Special Provision SP09-R005 located at:

<https://connect.ncdot.gov/resources/Specifications/Pages/2024-Specifications-and-Special-Provisions.aspx>

4.3. POLE NUMBERING SYSTEM

A. New Poles

Attach an identification tag to each pole shaft section as shown on Metal Pole Standard Sheet M2 “Typical Fabrication Details for All Metal Poles.”

4.4. MEASUREMENT AND PAYMENT

Actual number of metal strain signal poles (without regard to height or load capacity) furnished, installed and accepted.

Actual number of designs for metal strain poles furnished and accepted.

Actual number of soil tests with SPT borings drilled furnished and accepted.

Actual volume of concrete poured in cubic yards of drilled pier foundation furnished, installed and accepted.

No measurement will be made for foundation designs prepared with metal pole designs, as these will be considered incidental to designing Traffic Signal , CCTV or MVD support structures.

Payment will be made under:

Metal Strain Signal Pole.....	Each
Metal Strain Pole Design.....	Each
Soil Test.....	Each
Drilled Pier Foundation.....	Cubic Yard

5. ETHERNET EDGE SWITCH

Furnish and install a managed Ethernet edge switch as specified below that is fully compatible, interoperable, and completely interchangeable and functional within the existing City, Division, or Statewide traffic signal system communications network.

5.1. DESCRIPTION

A. Ethernet Edge Switch:

Furnish and install a hardened, field Ethernet edge switch (hereafter “edge switch”) for the traffic signal controller or ITS device as specified below. Ensure that the edge switch provides wire-speed, fast Ethernet connectivity at transmission rates of 1000 megabits per second from each remote traffic signal controller or ITS device location to the routing switches.

Contact the City or NCDIT to arrange for the programming of the new Field Ethernet Switches with the necessary network configuration data, including but not limited to, the IP Address, Default Gateway, Subnet Mask and VLAN ID information. Provide a minimum ten (10) working days notice to allow the City or NCDIT to program the new devices.

B. Network Management:

Ensure that the edge switch is fully compatible with the existing City, Division, or Statewide Network Management Software.

5.2. MATERIALS

A. General:

Ensure that the edge switch is fully compatible and interoperable with the trunk Ethernet network interface and that the edge switch supports half and full duplex Ethernet communications.

Furnish an edge switch that provide 99.999% error-free operation, and that complies with the Electronic Industries Alliance (EIA) Ethernet data communication requirements using single-mode fiber-optic transmission medium and copper transmission medium. Ensure that the edge switch has a minimum mean time between failures (MTBF) of 10 years, or 87,600 hours, as calculated using the Bellcore/Telcordia SR-332 standard for reliability prediction.

B. Compatibility Acceptance

The Engineer has the authority to require the Contractor to submit a sample Field Ethernet Switch and SFP along with all supporting documentation, software and testing procedures to allow a compatibility acceptance test be performed prior to approving the proposed Field Ethernet Switch and Field Ethernet Transceiver for deployment. **The Compatibility Acceptance testing will ensure that the proposed device is 100% compatible and interoperable with the existing City, Division, or Statewide Signal System network, monitoring software and Traffic Operations Center network hardware.** Allow fifteen (15) working days for the Compatibility Acceptance Testing to be performed

C. Standards:

Ensure that the edge switch complies with all applicable IEEE networking standards for Ethernet communications, including but not limited to:

- IEEE 802.1D standard for media access control (MAC) bridges used with the Spanning Tree Protocol (STP);
- IEEE 802.1Q standard for port-based virtual local area networks (VLANs);
- IEEE 802.1P standard for Quality of Service (QoS);

- IEEE 802.1w standard for MAC bridges used with the Rapid Spanning Tree Protocol (RSTP);
- IEEE 802.1s standard for MAC bridges used with the Multiple Spanning Tree Protocol;
- IEEE 802.1x standard for port based network access control, including RADIUS;
- IEEE 802.3 standard for local area network (LAN) and metropolitan area network (MAN) access and physical layer specifications;
- IEEE 802.3u supplement standard regarding 100 Base TX/100 Base FX;
- IEEE 802.3x standard regarding flow control with full duplex operation; and
- IFC 2236 regarding IGMP v2 compliance.
- IEEE 802.1AB Link Layer Discovery Protocol (LLDP)
- IEEE 802.3ad Ethernet Link Aggregation
- IEEE 802.3i for 10BASE-T (10 Mbit/s over Fiber-Optic)
- IEEE 802.3ab for 1000BASE-T (1Gbit/s over Ethernet)
- IEEE 802.3z for 1000BASE-X (1 Gbit/s Ethernet over Fiber-Optic)

D. Functional:

Ensure that the edge switch supports all Layer 2 management features and certain Layer 3 features related to multicast data transmission and routing. These features shall include, but not be limited to:

- An STP healing/convergence rate that meets or exceeds specifications published in the IEEE 802.1D standard.
- An RSTP healing/convergence rate that meets or exceeds specifications published in the IEEE 802.1w standard.
- An Ethernet edge switch that is a port-based VLAN and supports VLAN tagging that meets or exceeds specifications as published in the IEEE 802.1Q standard, and has a minimum 4-kilobit VLAN address table (254 simultaneous).
- A forwarding/filtering rate that is a minimum of 14,880 packets per second for 10 megabits per second and 148,800 packets per second for 100 megabits per second.
- A minimum 4-kilobit MAC address table.
- Support of Traffic Class Expediting and Dynamic Multicast Filtering.
- Support of, at a minimum, snooping of Version 2 & 3 of the Internet Group Management Protocol (IGMP).
- Support of remote and local setup and management via telnet or secure Web-based GUI and command line interfaces.
- Support of the Simple Network Management Protocol version 3 (SNMPv3). Verify that the Ethernet edge switch can be accessed using the resident EIA-232 management port, a telecommunication network, or the Trivial File Transfer Protocol (TFTP).
- Port security through controlling access by the users. Ensure that the Ethernet edge switch has the capability to generate an alarm and shut down ports when an unauthorized user accesses the network.
- Support of remote monitoring (RMON-1 & RMON-2) of the Ethernet agent.
- Support of the TFTP and SNTP. Ensure that the Ethernet edge switch supports port mirroring for troubleshooting purposes when combined with a network analyzer.

E. Physical Features:

Ports: Provide 10/100/1000 Mbps auto-negotiating ports (RJ-45) copper Fast Ethernet ports for all edge switches. Provide auto-negotiation circuitry that will automatically negotiate the highest possible data rate and duplex operation possible with attached devices supporting the IEEE 802.3 Clause 28 auto-negotiation standard.

Optical Ports: Ensure that all fiber-optic link ports operate at 1310 or 1550 nanometers in single mode. Provide Type LC connectors for the optical ports, as specified in the Plans or by the Engineer. Do not use mechanical transfer registered jack (MTRJ) type connectors.

Provide an edge switch having a minimum of two optical 100/1000 Base X ports capable of transmitting data at 100/1000 megabits per second. Ensure that each optical port consists of a pair of fibers; one fiber will transmit (TX) data and one fiber will receive (RX) data. Ensure that the optical ports have an optical power budget of at least 15 dB. Provide small form-factor pluggable modules (SFPs) with a maximum range that meets or exceeds the distance requirement as indicated on the Plans.

Copper Ports: Provide an edge switch that includes a minimum of four copper ports. Provide Type RJ-45 copper ports and that auto-negotiate speed (i.e., 10/100/1000 Base) and duplex (i.e., full or half). Ensure that all 10/100/1000 Base TX ports meet the specifications detailed in this section and are compliant with the IEEE 802.3 standard pinouts. Ensure that all Category 6 unshielded twisted pair/shielded twisted pair network cables are compliant with the EIA/TIA-568-B standard.

Port Security: Ensure that the edge switch supports/complies with the following (remotely) minimum requirements:

- Ability to configure static MAC addresses access;
- Ability to disable automatic address learning per ports; know hereafter as Secure Port. Secure Ports only forward; and
- Trap and alarm upon any unauthorized MAC address and shutdown for programmable duration. Port shutdown requires administrator to manually reset the port before communications are allowed.

F. Management Capabilities:

Ensure that the edge switch supports all Layer 2 management features and certain Layer 3 features related to multicast data transmission and routing. These features shall include, but not be limited to:

- An STP healing/convergence rate that meets or exceeds specifications published in the IEEE 802.1 D standards;
- An RSTP healing/convergence rate that meets or exceeds specifications published in the IEEE 802.1w standard;
- An Ethernet edge switch that is a port-based VLAN and supports VLAN tagging that meets or exceeds specifications as published in the IEEE 802.1Q standard, and has a minimum 4-kilobit VLAN address table (254 simultaneous);
- A forwarding/filtering rate that is a minimum of 14,880 packets per second for 10 megabits per second, 148,800 packets per second for 100 megabits per second and 1,488,000 packets per second for 1000 megabits per second;
- A minimum 4-kilobit MAC address table;
- Support of Traffic Class Expediting and Dynamic Multicast Filtering.

- Support of, at a minimum, snooping of Version 2 & 3 of the Internet Group Management Protocol (IGMP);
- Support of remote and local setup and management via telnet or secure Web-based GUI and command line interfaces; and
- Support of the Simple Network Management Protocol (SNMP). Verify that the Ethernet edge switch can be accessed using the resident EIA-232 management port, a telecommunication network, or the Trivial File Transfer Protocol (TFTP).

Network Capabilities: Provide an edge switch that supports/complies with the following minimum requirements:

- Provide full implementation of IGMPv2 snooping (RFC 2236);
- Provide full implementation of SNMPv1, SNMPv2c, and/or SNMPv3;
- Provide support for the following RMON–I groups, at a minimum:
 - Part 1: Statistics
 - Part 2: History
 - Part 3: Alarm
 - Part 9: Event
- Provide support for the following RMON–2 groups, at a minimum:
 - Part 13: Address Map
 - Part 16: Layer Host
 - Part 17: Layer Matrix
 - Part 18: User History
- Capable of mirroring any port to any other port within the switch;
- Meet the IEEE 802.1Q (VLAN) standard per port for up to four VLANs;
- Meet the IEEE 802.3ad (Port Trunking) standard for a minimum of two groups of four ports;
- Password manageable;
- Telnet/CLI;
- HTTP (Embedded Web Server) with Secure Sockets Layer (SSL); and
- Full implementation of RFC 783 (TFTP) to allow remote firmware upgrades.

Network Security: Provide an edge switch that supports/complies with the following (remotely) minimum network security requirements:

- Multi-level user passwords;
- RADIUS centralized password management (IEEE 802.1X);
- SNMPv3 encrypted authentication and access security;
- Port security through controlling access by the users: ensure that the Ethernet edge switch has the capability to generate an alarm and shut down ports when an unauthorized user accesses the network;
- Support of remote monitoring (RMON-1&2) of the Ethernet agent; and
- Support of the TFTP and SNTP. Ensure that the Ethernet edge switch supports port mirroring for troubleshooting purposes when combined with a network analyzer.

G. Electrical Specifications:

Ensure that the edge switch operates and power is supplied with 115 volts of alternating current (VAC). Ensure that the edge switch has a minimum operating input of 110 VAC and a maximum operating input of 130 VAC. Ensure that if the device requires operating voltages other than 120 VAC, supply the required voltage converter. Ensure that the maximum power consumption does not

exceed 50 watts. Ensure that the edge switch has diagnostic light emitting diodes (LEDs), including link, TX, RX, speed (for Category 6 ports only), and power LEDs.

H. Environmental Specifications:

Ensure that the edge switch performs all of the required functions during and after being subjected to an ambient operating temperature range of -30 degrees to 165 degrees Fahrenheit as defined in the environmental requirements section of the NEMA TS 2 standard, with a noncondensing humidity of 0 to 95%.

Provide certification that the device has successfully completed environmental testing as defined in the environmental requirements section of the NEMA TS 2 standard. Provide certification that the device meets the vibration and shock resistance requirements of Sections 2.1.9 and 2.1.10, respectively, of the NEMA TS 2 standard. Ensure that the edge switch is protected from rain, dust, corrosive elements, and typical conditions found in a roadside environment.

The edge switch shall meet or exceed the following environmental standards:

- IEEE 1613 (electric utility substations)
- IEC 61850-3 (electric utility substations)
- IEEE 61800-3 (variable speed drive systems)
- IEC 61000-6-2 (generic industrial)
- EMF – FCC Part 15 CISPR (EN5502) Class A

I. Ethernet Patch Cable:

Furnish a factory pre-terminated/pre-connectorized Ethernet patch cable with each edge switch. Furnish Ethernet patch cables meeting the following physical requirements:

- Five (5)-foot length
- Category 6 or better
- Factory-installed RJ-45 connectors on both ends
- Molded anti-snag hoods over connectors
- Gold plated connectors
- Copper-clad aluminum is **NOT** allowed.

Furnish Fast Ethernet patch cords meeting the following minimum performance requirements:

- TIA/EIA-568-B-5, Additional Transmission Performance Specifications for 4-pair 100 Ω Enhanced Category 6 Cabling
- Frequency Range: 1-100 MHz
- Near-End Crosstalk (NEXT): 30.1 dB
- Power-sum NEXT: 27.1 dB
- Attenuation to Crosstalk Ratio (ACR): 6.1 dB
- Power-sum ACR: 3.1 dB
- Return Loss: 10dB
- Propagation Delay: 548 nsec

5.3. CONSTRUCTION METHODS

A. General:

Ensure that the edge switch is UL listed.

U-4713A

TS-47

Mecklenburg County

Verify that network/field/data patch cords meet all ANSI/EIA/TIA requirements for Category 6 four-pair unshielded twisted pair cabling with stranded conductors and RJ45 connectors.

Contact the City, Division, or NCDIT a minimum of 10 working days prior to installation to allow for the programming of the edge switch.

B. Edge Switch:

Mount the edge switch inside each field cabinet by securely fastening the edge switch to the upper end of the right rear vertical rail of the equipment rack using manufacturer-recommended or Engineer-approved attachment methods, attachment hardware and fasteners.

Ensure that the edge switch is mounted securely in the cabinet and is fully accessible by field technicians without blocking access to other equipment. Verify that fiber-optic jumpers consist of a length of cable that has connectors on both ends, primarily used for interconnecting termination or patching facilities and/or equipment.

5.4. MEASUREMENT AND PAYMENT

Ethernet edge switch will be measured and paid as the actual number of Ethernet edge switches furnished, installed, and accepted.

No separate measurement will be made for Ethernet patch cable, small form factor pluggable modules (SFPs), power cord, mounting hardware, nuts, bolts, brackets, or edge switch programming as these will be considered incidental to furnishing and installing the edge switch.

Payment will be made under:

Ethernet Edge Switch Each

Project U-4713A

ST-1

Mecklenburg County

Project Special Provisions Structures

Table of Contents

	<u>Page No.</u>
Optional Precast Reinforced Concrete Box Culvert at Station (11-30-23) -----	ST-2
Falsework and Formwork (11-30-23) -----	ST-10
Submittal of Working Drawings (11-30-23) -----	ST-16
Crane Safety (6-20-19) -----	ST-22
Grout for Structures (12-1-17) -----	ST-23
Sound Barrier Wall (11-30-23) -----	ST-24

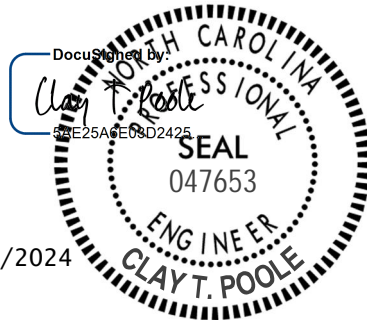

9/12/2024

Project U-4713A

ST-2

Mecklenburg County

**OPTIONAL PRECAST REINFORCED CONCRETE
BOX CULVERT AT STATION 43+65.00 -L-****(11-30-23)****GENERAL**

This Special Provision covers the design, fabrication and construction of precast reinforced concrete box culverts intended for the conveyance of storm water.





If the option is indicated on the plans, the submittal for a precast reinforced box culvert in lieu of a cast-in-place culvert is permitted. Design the precast culvert sections in accordance with ASTM C1577 or the current edition of the *AASHTO LRFD Bridge Design Specifications*. Rate all sizes of precast reinforced concrete box culverts in accordance with the current edition of the *AASHTO Manual for Bridge Evaluation*. Ensure the culvert rates for the AASHTO design loads, North Carolina's legal loads (see section North Carolina's Legal Loads), and Fixing America's Surface Transportation (FAST) Act's emergency vehicles (EV). Provide the size and number of barrels as indicated on the plans. Detail the culvert with cast-in-place wings walls and footings. Precast wing walls and footings will not be allowed. Provide a precast box culvert that meets the requirements of Section 1077 and any other applicable parts of the *Standard Specifications*.

The design and rating of the precast and cast-in-place members is the responsibility of the Contractor and is subject to review, comments, and approval. Submit two (2) sets of detailed plans and rating sheets for review. Include all details in the plans, including the size and spacing of the required reinforcement necessary to build the precast box and cast-in-place members. Have a North Carolina Registered Professional Engineer check and seal the plans, rating sheets and design calculations. After the plans, rating sheets and design calculations are reviewed and, if necessary, the corrections made, submit one set of plans and rating sheets on 22" x 34" sheets to become part of the contract plans.

If the span, rise and design earth cover for the precast reinforced concrete box culvert are identical to a previously approved submittal, the Contractor may request the previously approved design calculations and plans be considered as the submittal for review and approval. However, a set of plans and rating sheets will need to be submitted to become part of the contract plans.

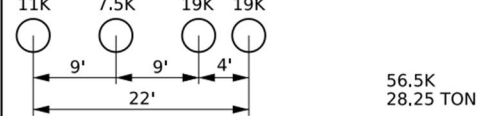
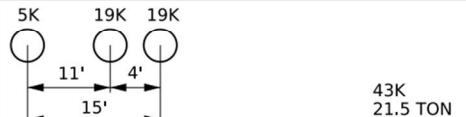
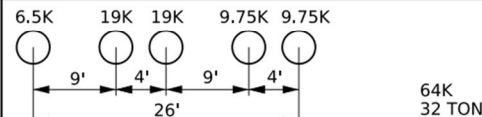
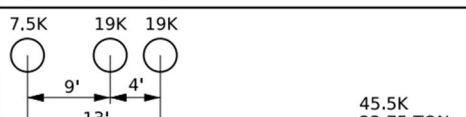
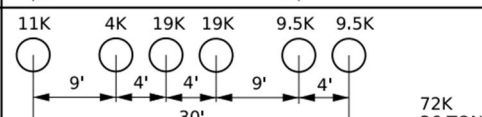
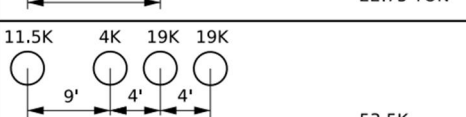
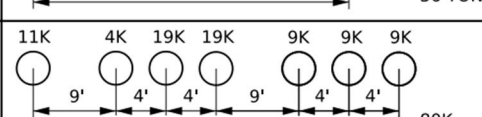
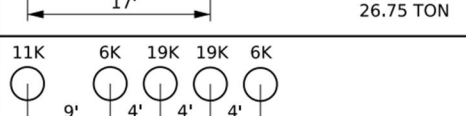
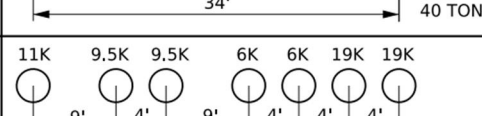
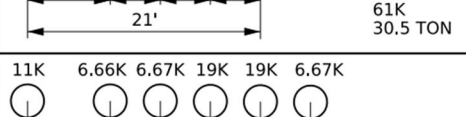
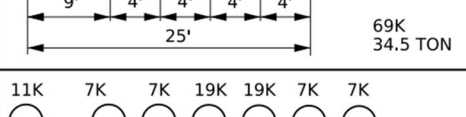

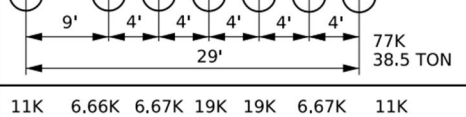



NORTH CAROLINA'S LEGAL LOADS

Apply the following legal loads to all structures carrying interstate traffic:

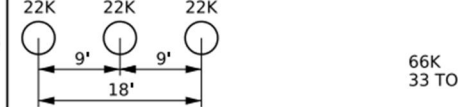
NORTH CAROLINA LEGAL LOADS			
SINGLE VEHICLE (SV)		TRUCK TRACTOR SEMI-TRAILER (TTST)	
*REF.#	SCHEMATIC	*REF.#	SCHEMATIC
SH (I01)		T4A (I09)	
S3C (I02)		T5B (I10)	
S3A (I03)		T6A (I11)	
S4A (I04)		T7A (I12)	
S5A (I05)		T7B (I13)	
S6A (I06)		FAST ACT EMERGENCY VEHICLES	
		REF.#	SCHEMATIC
S7B (I07)		EV2	
S7A (I08)		EV3	

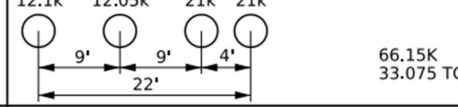
* () = NC LEGAL LOAD CODE FOR THE SPECIFICATIONS FOR THE NATIONAL BRIDGE INVENTORY (SNBI) ITEM ID B.EP.01

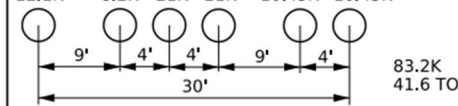
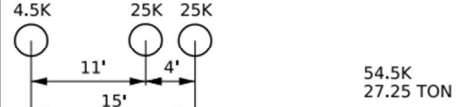
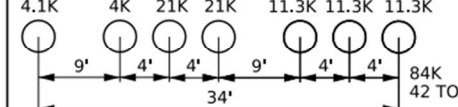
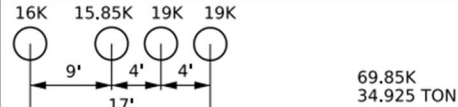
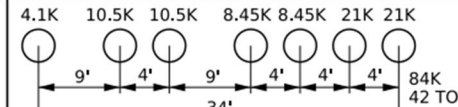
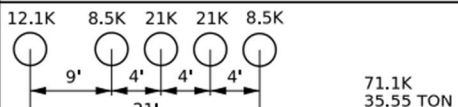
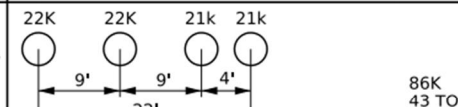
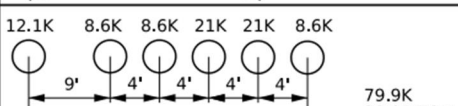
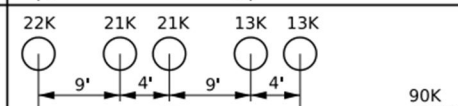
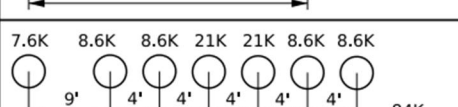
Apply the following legal loads to all structures carrying non-interstate traffic:

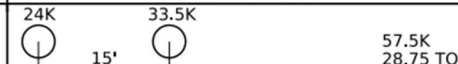
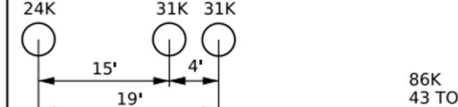
NORTH CAROLINA LEGAL LOADS			
SINGLE VEHICLE (SV)		TRUCK TRACTOR SEMI-TRAILER (TTST)	
* REF. #	SCHEMATIC	* REF. #	SCHEMATIC
SNSH (N01)		TNAGRIT3 (N09)	
SNGARBS2 (N02)		TNT4A (N10)	
SNAGRIS2 (N03)		TNT6A (N11)	
SNCOTTS3 (N04)		TNT7A (N12)	
SNAGGRS4 (N05)		TNT7B (N13)	
SNS5A (N06)		TNAGRIT4 (N14)	
SNS6A (N07)		TNAGT5A (N15)	
SNS7B (N08)		TNAGT5B (N16)	
FAST ACT EMERGENCY VEHICLES			
REF. #	SCHEMATIC		
EV2			
EV3			

* () = NC LEGAL LOAD CODE FOR THE SPECIFICATIONS FOR THE NATIONAL BRIDGE INVENTORY (SNBI) ITEM ID B.EP.01

Project U-4713A

ST-5

Mecklenburg County

PRECAST REINFORCED CONCRETE BOX SECTIONS

The precast reinforced concrete box culvert sections shall match the size and hydraulic opening indicated in the contract plans.

(A) Design

- (1) Design Fill – The design earth cover is reported on the plans as the elevation difference between the point of maximum fill and the bottom of the top slab.
- (2) Placement of Reinforcement – Provide a 1 inch concrete cover over the reinforcement subject to the provisions of Section E. Extend the inside reinforcement into the tongue portion of the joint and the outside reinforcement into the groove portion of the joint. Detail the clear distance of the end wires so it is not less than ½ inch or more than two (2) inches from the ends of the box section. Assemble reinforcement per the requirements of ASTM C1577 or the approved design. The exposure of the ends of the wires used to position the reinforcement is not a cause for rejection.
- (3) Laps and Spacing – Use lap splices for the transverse reinforcement. Detail the transverse wires so that the center to center spacing is not less than two (2) inches or more than four (4) inches. Do not detail the longitudinal wires with a center to center spacing of more than 8 inches.

(B) Joints

- (1) Produce the precast reinforced concrete box section with tongue and groove ends. Design and form these ends of the box section so, when the sections are laid together, they make a continuous line of box sections with a smooth interior free of appreciable irregularities in the flowline, all compatible with the permissible variations given in Section F. The internal joint formed at the tongue and groove ends of the precast units shall be sealed with either bitumen/butyl sealant or closed-cell neoprene material. The internal joint material shall be installed in accordance with the manufacturer's recommendations. The material shall be shown on the shop drawings when they are submitted for review.
- (2) Seal the external joint with an outside sealer wrap conforming to ASTM C877 that is at least 12 inches wide and covers the joint on both the sides and the top of the box section. Use ConWrap CS-212 from Concrete Sealants, Inc., EZ-Wrap from Press-Seal Gasket Corporation, Seal Wrap from Mar-Mac Manufacturing Co., Inc., Cadilloc External Pipe Joint from Cadilloc, or an approved equal for the outside sealer wrap. If the outside sealer wrap is not applied in a continuous strip along the entire joint, a 12 inch minimum lap of the outside sealer wrap is permitted. Before placing the outside sealer wrap, clean and prime the area receiving the outside sealer wrap in accordance with the sealer wrap manufacturer recommendations. The joint wrap manufacturer installation recommendations shall be included with shop drawings submitted for review. The external joint wrap shall be installed in pieces, as indicated on Figure 1 below:

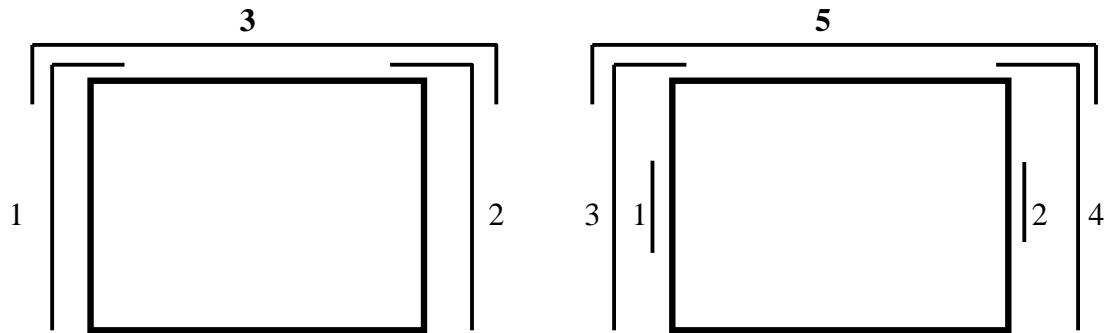

Figure 1

Cover the external joint sealer with a 3 foot strip of filter fabric conforming to Type 4 requirements in Section 1056 of the *Standard Specifications*.

Place multiple lines of a precast reinforced concrete box culvert such that the longitudinal joint between the sections has a minimum width of three (3) inches. Fill the joint between multiple lines of precast box sections with Class A concrete. Use Class A concrete that meets the requirements listed in the *Standard Specifications* except that Field Compressive Strength Specimens are not required.

(C) Manufacture

Manufacture precast reinforced concrete box culvert sections by either the wet cast method or dry cast method.

- (1) Mixture – In addition to the requirements of Section 1077 of the *Standard Specifications*, do not proportion the mix with less than 564 lb/yd³ of Portland cement. When a flowable concrete consistency is required, refer to Section 1077-5(B) of the *Standard Specifications* for the use of Self-Consolidating Concrete (SCC) and Intermediate Flow Concrete.
- (2) Strength – Concrete shall develop a minimum 28-day compressive strength of 5,000 psi. Movement of the precast sections should be minimized during the initial curing period. Any damage caused by moving or handling during the initial curing phase will be grounds for rejection of that precast section.
- (3) Air Entrainment – Air entrain the concrete in accordance with Section 1077 – 5(A) of the *Standard Specifications*. For dry cast manufacturing, air entrainment is not required.
- (4) Testing – Test the concrete in accordance with the requirements of Section 1077 – 5(C) of the *Standard Specifications*.
- (5) Handling – Handling devices or holes are permitted in each box section for the purpose of handling and placing. Submit details of handling devices or holes for approval and do not cast any concrete until approval is granted. Remove all handling devices flush with

concrete surfaces as directed. Fill holes in a neat and workmanlike manner with an approved non-metallic non-shrink grout, concrete, or hole plug.

(D) Physical Requirements

Acceptability of precast culvert sections is based on concrete cylinders made and tested in accordance with ASTM C31 and ASTM C39.

(E) Permissible Variations

- (1) Flatness – All external surfaces shall be flat, true, and plumb. Irregularities, depressions, or high spots on all external surfaces shall not exceed $\frac{1}{2}$ inch in 8 feet.
- (2) Internal Dimensions – Produce sections so that the internal and haunch dimensions do not vary more than $\frac{1}{4}$ inch from the plan dimensions.
- (3) Adjacent Sections - Internal, external, and haunch dimensions for connecting sections shall not vary more than $\frac{1}{2}$ inch.
- (4) Length of Tongue and Groove – The minimum length of the tongue shall be four (4) inches. The minimum length of the groove shall be four (4) inches. The dimensions of the tongue and groove shall not vary more than $\frac{1}{4}$ inch from the plan dimensions.
- (5) Slab and Wall Thickness – Produce sections so that the slab and wall thickness are not less than that shown on the plans by more than 5% or $\frac{3}{16}$ inch, whichever is greater. A thickness more than that required on the plans is not a cause for rejection.
- (6) Length of Opposite Surfaces – Produce sections so that variations in laying lengths of two (2) opposite surfaces of the box section meet the requirements of ASTM C1577, Section 11.3.
- (7) Length of Section – Produce sections so that the underrun in length of a section is not more than $\frac{1}{2}$ inch in any box section.
- (8) Position of Reinforcement – Produce sections so that the maximum variation in the position of the reinforcement is $\pm \frac{3}{8}$ inch for slab and wall thicknesses of five (5) inches or less and $\pm \frac{1}{2}$ inch for slab and wall thicknesses greater than five (5) inches. Produce sections so that the concrete cover is never less than $\frac{5}{8}$ inch as measured to the internal surface or the external surface. The preceding minimum cover limitations do not apply at the mating surfaces of the joint.
- (9) Area of Reinforcement – Use the design steel shown on the plans for the steel reinforcement. Steel areas greater than those required are not cause for rejection. The permissible variation in diameter of any wire in finished fabric is prescribed for the wire before fabrication by either AASHTO M32 or M225.

(F) Marking

- (1) Each section shall be match-marked in order of intended installation as indicated on the approved shop drawings. Ensure that pieces fit together neatly and in a workmanlike manner. In order to ensure a good, neat field fit, the Department will verify assembly of the first five (5) adjacent sections or 20% of the total culvert length, whichever is greater, at the producer's facility and match-mark the pieces. This will require that a minimum of three (3) adjacent sections of the culvert be fitted at the production yard at a time and then match-marked. Once three (3) sections have been match-marked, the first section may be removed for shipment and a fourth section set for marking. Continue in a progressive manner until all sections have been properly match-marked. The producer shall document the GO-NO-GO dimensional measurements of each box culvert section produced through the post-pour inspection process.
- (2) Clearly mark each section of the box culvert in accordance with ASTM C1577, Section 15. The information requirements of Section 15.1 shall be clearly marked on the inner surface of each section.

(G) Construction

- (1) Pre-installation Meeting – A pre-installation meeting is required prior to installation. Representatives from the Contractor, the precast box manufacturer, and the Department should attend this meeting. The precast box manufacturer's representative shall be on site during installation.
- (2) Foundation – Foundation for precast box culvert shall meet the requirements of Section 414 of the *Standard Specifications*. In addition, Type VI foundation material shall be encapsulated in filter fabric conforming to Type 4 requirements in Section 1056 of the *Standard Specifications*. The filter fabric shall be placed perpendicular to the culvert barrel. Provide sufficient overhang beyond the excavation to allow a minimum lap of three (3) feet when the foundation material is placed, and fabric wrapped on top. Perpendicular sections of fabric shall be continuous. A minimum lap of two (2) feet shall be provided between sections of fabric.
- (3) Installation – Sections shall be placed at the beginning of the outlet end of the culvert with the groove end being laid upgrade. Tongue sections shall be laid into the groove sections. Positive means shall be provided to pull each section firmly into the previously placed section so that the joints are tightly homed. Use a "come-along" box pullers or other approved methods to create a positive means of joining box sections. Construction equipment shall not have direct contact with the box section. The load of the box shall be suspended by lifting device during joining procedure.
- (4) Backfill – Complete backfill in accordance with Section 414 of the *Standard Specifications*.

Project U-4713A

ST-9

Mecklenburg County

BASIS OF PAYMENT

Any additional cost of redesigning will be paid for by the Contractor if Precast Reinforced Concrete Culvert is used in lieu of the cast-in-place culvert shown on the plans. Except for Foundation Conditioning Material and Culvert Excavation, payment for the Precast Box Culvert will be a lump sum amount equal to the payment that would be allowed for construction of a Cast-in-Place Box Culvert. Plan quantities and unit bid prices will be used to compute the lump sum amount. Such price and payment will be full compensation for all work covered by this Special Provision, the plans and applicable parts of the *Standard Specifications* and will include, but not be limited to, furnishing all labor, materials (including all filter fabric), equipment and other incidentals necessary to complete this work. Such price and payment will also be full compensation for concrete, reinforcing steel, labor, equipment and all other related materials necessary for the completion of the barrel section, and the construction of the headwalls, leveling pad, end curtain walls, wings and wing footings.

FALSEWORK AND FORMWORK**(11-30-23)****GENERAL**

Use this Special Provision as a guide to develop temporary works submittals required by the *Standard Specifications* or other provisions; no additional submittals are required herein. Such temporary works include, but are not limited to, falsework and formwork.

Falsework is any temporary construction used to support the permanent structure until it becomes self-supporting. Formwork is the temporary structure or mold used to retain plastic or fluid concrete in its designated shape until it hardens. Access scaffolding is a temporary structure that functions as a work platform that supports construction personnel, materials, and tools, but is not intended to support the structure. Scaffolding systems that are used to temporarily support permanent structures (as opposed to functioning as work platforms) are considered to be falsework under the definitions given. Shoring is a component of falsework such as horizontal, vertical, or inclined support members. Where the term “temporary works” is used, it includes all of the temporary facilities used in bridge construction that do not become part of the permanent structure.

Design and construct safe and adequate temporary works that will support all loads imposed and provide the necessary rigidity to achieve the lines and grades shown on the plans in the final structure.

MATERIALS

Select materials suitable for temporary works; however, select materials that also ensure the safety and quality required by the design assumptions. The Engineer has authority to reject material on the basis of its condition, inappropriate use, safety, or nonconformance with the plans. Clearly identify allowable loads or stresses for all materials or manufactured devices on the plans. Revise the plan and notify the Engineer if any change to materials or material strengths is required.

DESIGN REQUIREMENTS**(A) Working Drawings**

Provide working drawings for items as specified in the contract, or as required by the Engineer, with design calculations and supporting data in sufficient detail to permit a structural and safety review of the proposed design of the temporary work.

On the drawings, show all information necessary to allow the design of any component to be checked independently as determined by the Engineer.

When concrete placement is involved, include data such as the drawings of proposed sequence, rate of placement, direction of placement, and location of all construction joints.

When required, have the drawings and calculations prepared under the guidance of, and sealed by, a North Carolina Registered Professional Engineer who is knowledgeable in temporary works design.

If requested by the Engineer, submit with the working drawings manufacturer's catalog data listing the weight of all construction equipment that will be supported on the temporary work. Show anticipated total settlements and/or deflections of falsework and forms on the working drawings. Include falsework footing settlements, joint take-up, and deflection of beams or girders.

As an option for the Contractor, overhang falsework hangers may be uniformly spaced, at a maximum of 36 inches, provided the following conditions are met:

Member Type (PCG)	Member Depth, (inches)	Max. Overhang Width, (inches)	Max. Slab Edge Thickness, (inches)	Max. Screenshot Wheel Weight, (lbs.)	Bracket Min. Vertical Leg Extension, (inches)
II	36	39	14	2000	26
III	45	42	14	2000	35
IV	54	45	14	2000	44
MBT	63	51	12	2000	50
MBT	72	55	12	1700	48

Overhang width is measured from the centerline of the girder to the edge of the deck slab. For Type II, III & IV prestressed concrete girders (PCG), 45-degree cast-in-place half hangers and rods must have a minimum safe working load of 6,000 lbs.

For MBT prestressed concrete girders, 45-degree angle holes for falsework hanger rods shall be cast through the girder top flange and located, measuring along the top of the member, 1'-2 1/2" from the edge of the top flange. Hanger hardware and rods must have a minimum safe working load of 6,000 lbs.

For link slabs, the top of girders directly beneath the link slab shall be free of overhang falsework attachments or other hardware. Submit calculations and working drawings for overhang falsework in the link slab region.

The overhang bracket provided for the diagonal leg shall have a minimum safe working load of 3,750 lbs. The vertical leg of the bracket shall extend to the point that the heel bears on the girder bottom flange, no closer than 4 inches from the bottom of the member. However, for 72-inch members, the heel of the bracket shall bear on the web, near the bottom flange transition.

Provide adequate overhang falsework and determine the appropriate adjustments for deck geometry, equipment, casting procedures and casting conditions.

If the optional overhang falsework spacing is used, indicate this on the falsework submittal and advise the girder producer of the proposed details. Failure to notify the Engineer of hanger type and hanger spacing on prestressed concrete girder casting drawings may delay the approval of those drawings.

Falsework hangers that support concentrated loads and are installed at the edge of thin top flange concrete girders (such as bulb tee girders) shall be spaced so as not to exceed 75% of the manufacturer’s stated safe working load. Use of dual leg hangers (such as Meadow Burke HF-42 and HF-43) are not allowed on concrete girders with thin top flanges. Design the falsework and forms supporting deck slabs and overhangs on girder bridges so that there will be no differential settlement between the girders and the deck forms during placement of deck concrete.

When staged construction of the bridge deck is required, detail falsework and forms for screed and fluid concrete loads to be independent of any previous deck pour components when the mid-span girder deflection due to deck weight is greater than 3/4”.

Note on the working drawings any anchorages, connectors, inserts, steel sleeves or other such devices used as part of the falsework or formwork that remains in the permanent structure. If the plan notes indicate that the structure contains the necessary corrosion protection required for a Corrosive Site, epoxy coat, galvanize or metalize these devices. Electroplating will not be allowed. Any coating required by the Engineer will be considered incidental to the various pay items requiring temporary works.

Design falsework and formwork requiring submittals in accordance with the current edition of AASHTO Guide Design Specifications for Bridge Temporary Works except as noted herein.

(1) Wind Loads

Table 2.2 of Article 2.2.5.1 is modified to include wind velocities up to 110 mph. In addition, Table 2.2A is included to provide the maximum wind speeds by county in North Carolina.

Table 2.2 - Wind Pressure Values

Height Zone feet above ground	Pressure, lb/ft2 for Indicated Wind Velocity, mph				
	70	80	90	100	110
0 to 30	15	20	25	30	35
30 to 50	20	25	30	35	40
50 to 100	25	30	35	40	45
over 100	30	35	40	45	50

(2) Time of Removal

The following requirements replace those of Article 3.4.8.2.

Do not remove forms until the concrete has attained strengths required in Article 420-16 of the Standard Specifications and these Special Provisions.

Do not remove forms until the concrete has sufficient strength to prevent surface damage.

Table 2.2A - Steady State Maximum Wind Speeds by Counties in North Carolina

COUNTY	25 YR (mph)	COUNTY	25 YR (mph)	COUNTY	25 YR (mph)
Alamance	70	Franklin	70	Pamlico	100
Alexander	70	Gaston	70	Pasquotank	100
Alleghany	70	Gates	90	Pender	100
Anson	70	Graham	80	Perquimans	100
Ashe	70	Granville	70	Person	70
Avery	70	Greene	80	Pitt	90
Beaufort	100	Guilford	70	Polk	80
Bertie	90	Halifax	80	Randolph	70
Bladen	90	Harnett	70	Richmond	70
Brunswick	100	Haywood	80	Robeson	80
Buncombe	80	Henderson	80	Rockingham	70
Burke	70	Hertford	90	Rowan	70
Cabarrus	70	Hoke	70	Rutherford	70
Caldwell	70	Hyde	110	Sampson	90
Camden	100	Iredell	70	Scotland	70
Carteret	110	Jackson	80	Stanley	70
Caswell	70	Johnston	80	Stokes	70
Catawba	70	Jones	100	Surry	70
Cherokee	80	Lee	70	Swain	80
Chatham	70	Lenoir	90	Transylvania	80
Chowan	90	Lincoln	70	Tyrell	100
Clay	80	Macon	80	Union	70
Cleveland	70	Madison	80	Vance	70
Columbus	90	Martin	90	Wake	70
Craven	100	McDowell	70	Warren	70
Cumberland	80	Mecklenburg	70	Washington	100
Currituck	100	Mitchell	70	Watauga	70
Dare	110	Montgomery	70	Wayne	80

Davidson	70	Moore	70	Wilkes	70
Davie	70	Nash	80	Wilson	80
Duplin	90	New Hanover	100	Yadkin	70
Durham	70	Northampton	80	Yancey	70
Edgecombe	80	Onslow	100		
Forsyth	70	Orange	70		

(B) Review and Approval

The Engineer is responsible for the review and approval of temporary works’ drawings.

Submit the working drawings sufficiently in advance of proposed use to allow for their review, revision (if needed), and approval without delay to the work.

The time period for review of the working drawings does not begin until complete drawings and design calculations, when required, are received by the Engineer.

Do not start construction of any temporary work for which working drawings are required until the drawings have been approved. Such approval does not relieve the Contractor of the responsibility for the accuracy and adequacy of the working drawings.

CONSTRUCTION REQUIREMENTS

All requirements of Section 420 of the *Standard Specifications* apply.

Construct temporary works in conformance with the approved working drawings. Ensure that the quality of materials and workmanship employed is consistent with that assumed in the design of the temporary works. Do not weld falsework members to any portion of the permanent structure unless approved. Show any welding to the permanent structure on the approved construction drawings.

Provide tell-tales attached to the forms and extending to the ground, or other means, for accurate measurement of falsework settlement. Make sure that the anticipated compressive settlement and/or deflection of falsework does not exceed 1 inch. For cast-in-place concrete structures, make sure that the calculated deflection of falsework flexural members does not exceed 1/240 of their span regardless of whether or not the deflection is compensated by camber strips.

(A) Maintenance and Inspection

Inspect and maintain the temporary work in an acceptable condition throughout the period of its use. Certify that the manufactured devices have been maintained in a condition to allow them to safely carry their rated loads. Clearly mark each piece so that its capacity can be readily determined at the job site.

Project U-4713A

ST-15

Mecklenburg County

Perform an in-depth inspection of an applicable portion(s) of the temporary works, in the presence of the Engineer, not more than 24 hours prior to the beginning of each concrete placement. Inspect other temporary works at least once a month to ensure that they are functioning properly. Have a North Carolina Registered Professional Engineer inspect the cofferdams, shoring, sheathing, support of excavation structures, and support systems for load tests prior to loading.

(B) Foundations

Determine the safe bearing capacity of the foundation material on which the supports for temporary works rest. If required by the Engineer, conduct load tests to verify proposed bearing capacity values that are marginal or in other high-risk situations.

The use of the foundation support values shown on the contract plans of the permanent structure is permitted if the foundations are on the same level and on the same soil as those of the permanent structure.

Allow for adequate site drainage or soil protection to prevent soil saturation and washout of the soil supporting the temporary works supports.

If piles are used, the estimation of capacities and later confirmation during construction using standard procedures based on the driving characteristics of the pile is permitted. If preferred, use load tests to confirm the estimated capacities; or, if required by the Engineer conduct load tests to verify bearing capacity values that are marginal or in other high risk situations.

The Engineer reviews and approves the proposed pile and soil bearing capacities.

REMOVAL

Unless otherwise permitted, remove and keep all temporary works upon completion of the work. Do not disturb or otherwise damage the finished work.

Remove temporary works in conformance with the contract documents. Remove them in such a manner as to permit the structure to uniformly and gradually take the stresses due to its own weight.

MEASUREMENT AND PAYMENT

Unless otherwise specified, *Falsework and Formwork* will not be directly measured.

Payment at the contract unit prices for the various pay items requiring temporary works will be full compensation for the above falsework and formwork.

Project U-4713A

ST-16

Mecklenburg County

SUBMITTAL OF WORKING DRAWINGS**(11-30-23)****GENERAL**

Submit working drawings in accordance with Article 105-2 of the *Standard Specifications* and this Special Provision. For this Special Provision, “submittals” refers to only those listed in this Special Provision. The list of submittals contained herein does not represent a list of required submittals for the project. Submittals are only necessary for those items as required by the contract. Make submittals that are not specifically noted in this provision directly to the Engineer. Either the Structures Management Unit or the Geotechnical Engineering Unit or both units will jointly review submittals.

If a submittal contains variations from plan details or specifications or significantly affects project cost, field construction or operations, discuss the submittal with and submit all copies to the Engineer. State the reason for the proposed variation in the submittal. To minimize review time, make sure all submittals are complete when initially submitted. Provide a contact name and information with each submittal. Direct any questions regarding submittal requirements to the Engineer, Structures Management Unit contacts or the Geotechnical Engineering Unit contacts noted below.

To facilitate in-plant inspection by NCDOT and approval of working drawings, provide the name, address and telephone number of the facility where fabrication will actually be done if different than shown on the title block of the submitted working drawings. This includes, but is not limited to, precast concrete items, prestressed concrete items and fabricated steel or aluminum items.

ADDRESSES AND CONTACTS

For submittals to the Structures Management Unit, use the following addresses:

Via Email: SMU-wdr@ncdot.gov (do not cc SMU Working Drawings staff)

Via US mail:

Mr. B. C. Hanks, P. E.
State Structures Engineer
North Carolina Department
of Transportation
Structures Management Unit
1581 Mail Service Center
Raleigh, NC 27699-1581

Attention: Mr. J. L. Bolden, P. E.

Via other delivery service:

Mr. B. C. Hanks, P. E.
State Structures Engineer
North Carolina Department
of Transportation
Structures Management Unit
1000 Birch Ridge Drive
Raleigh, NC 27610

Attention: Mr. J. L. Bolden, P. E.

For submittals to the Geotechnical Engineering Unit, use the following addresses:

For projects in Divisions 1-7, use the following Eastern Regional Office addresses:

Via Email: EastGeotechnicalSubmittal@ncdot.gov

Project U-4713A

ST-17

Mecklenburg County

Via US mail:

Mr. Thomas Santee, P. E.
Assistant State Geotechnical
Engineer – Eastern Region
North Carolina Department
of Transportation
Geotechnical Engineering Unit
Eastern Regional Office
1570 Mail Service Center
Raleigh, NC 27699-1570

Via other delivery service:

Mr. Thomas Santee, P. E.
Assistant State Geotechnical
Engineer – Eastern Region
North Carolina Department
of Transportation
Geotechnical Engineering Unit
Eastern Regional Office
3301 Jones Sausage Road, Suite 100
Garner, NC 27529

For projects in Divisions 8-14, use the following Western Regional Office addresses:

Via Email: WestGeotechnicalSubmittal@ncdot.gov

Via US mail or other delivery service:

Mr. Eric Williams, P. E.
Assistant State Geotechnical
Engineer – Western Region
North Carolina Department
of Transportation
Geotechnical Engineering Unit
Western Regional Office
5253 Z Max Boulevard
Harrisburg, NC 28075

The status of the review of structure-related submittals sent to the Structures Management Unit can be viewed from the Unit’s website, via the “[Drawing Submittal Status](#)” link.

The status of the review of geotechnical-related submittals sent to the Geotechnical Engineering Unit can be viewed from the Unit’s website, via the “[Geotechnical Construction Submittals](#)” link.

Direct any questions concerning submittal review status, review comments or drawing markups to the following contacts:

Primary Structures Contact: James Bolden (919) 707 – 6408
jlbolden@ncdot.gov

Secondary Structures Contacts: Emmanuel Omile (919) 707 – 6451
eomile@ncdot.gov

Madonna Rorie (919) 707 – 6508
mrorie@ncdot.gov

Project U-4713A

ST-18

Mecklenburg County

Eastern Regional Geotechnical Contact (Divisions 1-7):

Thomas Santee (919) 920-8901

tgsantee@ncdot.gov

Western Regional Geotechnical Contact (Divisions 8-14):

Eric Williams (704) 455 – 8902

ewilliams3@ncdot.gov**SUBMITTAL COPIES**

Furnish one complete copy of each submittal, including all attachments, to the Engineer. At the same time, submit a copy of the same complete submittal directly to the Structures Management Unit and/or the Geotechnical Engineering Unit as specified in the tables below.

The first table below covers “Structure Submittals.” The Engineer will receive review comments and drawing markups for these submittals from the Structures Management Unit. The second table in this section covers “Geotechnical Submittals.” The Engineer will receive review comments and drawing markups for these submittals from the Geotechnical Engineering Unit.

Unless otherwise required, submit one set of supporting calculations to either the Structures Management Unit or the Geotechnical Engineering Unit unless both units require submittal copies in which case submit a set of supporting calculations to each unit. Provide additional copies of any submittal as directed.

STRUCTURE SUBMITTALS

Submittal	Submittal Required by Structures Management Unit?	Submittal Required by Geotechnical Engineering Unit?	Contract Reference Requiring Submittal ¹
Arch Culvert Falsework	Y	N	Plan Note, SN Sheet & “Falsework and Formwork”
Box Culvert Falsework ⁷	Y	N	Plan Note, SN Sheet & “Falsework and Formwork”
Cofferdams	Y	Y	Article 410-4
Foam Joint Seals ⁶	Y	N	“Foam Joint Seals”
Expansion Joint Seals (hold down plate type with base angle)	Y	N	“Expansion Joint Seals”
Expansion Joint Seals (modular)	Y	N	“Modular Expansion Joint Seals”

Project U-4713A

ST-19

Mecklenburg County

Expansion Joint Seals (strip seals)	Y	N	“Strip Seal Expansion Joints”
Falsework & Forms ² (substructure)	Y	N	Article 420-3 & “Falsework and Formwork”
Falsework & Forms (superstructure)	Y	N	Article 420-3 & “Falsework and Formwork”
Girder Erection over Railroad	Y	N	Railroad Provisions
Maintenance and Protection of Traffic Beneath Proposed Structure	Y	N	“Maintenance and Protection of Traffic Beneath Proposed Structure at Station ____”
Metal Bridge Railing	Y	N	Plan Note
Metal Stay-in-Place Forms	Y	N	Article 420-3
Metalwork for Elastomeric Bearings ^{4,5}	Y	N	Article 1072-8
Miscellaneous Metalwork ^{4,5}	Y	N	Article 1072-8
Disc Bearings ⁴	Y	N	“Disc Bearings”
Overhead and Digital Message Signs (DMS) (metalwork and foundations)	Y	N	Applicable Provisions
Placement of Equipment on Structures (cranes, etc.)	Y	N	Article 420-20
Prestressed Concrete Box Beam (detensioning sequences) ³	Y	N	Article 1078-11
Precast Concrete Box Culverts	Y	N	“Optional Precast Reinforced Concrete Box Culvert at Station ____”
Prestressed Concrete Cored Slab (detensioning sequences) ³	Y	N	Article 1078-11
Prestressed Concrete Deck Panels	Y	N	Article 420-3
Prestressed Concrete Girder (strand elongation and detensioning sequences)	Y	N	Articles 1078-8 and 1078- 11
Removal of Existing Structure over Railroad	Y	N	Railroad Provisions
Revised Bridge Deck Plans (adaptation to prestressed deck panels)	Y	N	Article 420-3

Project U-4713A

ST-20

Mecklenburg County

Revised Bridge Deck Plans (adaptation to modular expansion joint seals)	Y	N	“Modular Expansion Joint Seals”
Sound Barrier Wall (precast items)	Y	N	Article 1077-2 & “Sound Barrier Wall”
Sound Barrier Wall Steel Fabrication Plans ⁵	Y	N	Article 1072-8 & “Sound Barrier Wall”
Structural Steel ⁴	Y	N	Article 1072-8 Article 400-3 & “Construction, Maintenance and Removal of Temporary Structure at Station ____”
Temporary Detour Structures	Y	Y	
TFE Expansion Bearings ⁴	Y	N	Article 1072-8

FOOTNOTES

1. References are provided to help locate the part of the contract where the submittals are required. References in quotes refer to the provision by that name. Articles refer to the Standard Specifications.
2. Submittals for these items are necessary only when required by a note on plans.
3. Submittals for these items may not be required. A list of pre-approved sequences is available from the producer or the Materials & Tests Unit.
4. The fabricator may submit these items directly to the Structures Management Unit.
5. The two sets of preliminary submittals required by Article 1072-8 of the Standard Specifications are not required for these items.
6. Submittals for Fabrication Drawings are not required. Submittals for Catalogue Cuts of Proposed Material are required. See Section 5.A of the referenced provision.
7. Submittals are necessary only when the top slab thickness is 18” or greater.

Project U-4713A

ST-21

Mecklenburg County

GEOTECHNICAL SUBMITTALS

Submittal	Submittals Required by Geotechnical Engineering Unit	Submittals Required by Structures Management Unit	Contract Reference Requiring Submittal ¹
Drilled Pier Construction Plans ²	Y	N	Subarticle 411-3(A)
Crosshole Sonic Logging (CSL) Reports ²	Y	N	Subarticle 411-5(A)(2)
Pile Driving Equipment Data Forms ^{2,3}	Y	N	Subarticle 450-3(D)(2)
Pile Driving Analyzer (PDA) Reports ²	Y	N	Subarticle 450-3(F)(3)
Retaining Walls ⁴	Y; drawings and calculations	Y; drawings	Applicable Provisions
Temporary Shoring ⁴	Y; drawings and calculations	Y; drawings	“Temporary Shoring” & “Temporary Soil Nail Walls”

FOOTNOTES

- References are provided to help locate the part of the contract where the submittals are required. References in quotes refer to the provision by that name. Subarticles refer to the Standard Specifications.
- Submit one hard copy of submittal to the Engineer. Submit a second copy of submittal electronically (PDF via email), US mail or other delivery service to the appropriate Geotechnical Engineering Unit regional office. Electronic submission is preferred.
- The Pile Driving Equipment Data Form is available from:
<https://connect.ncdot.gov/projects/construction/ConstManRefDocs/PILE%20DRIVING%20EQUIPMENT%20DATA%20FORM.pdf>
See second page of form for submittal instructions.
- Electronic copy of submittal is required. See referenced provision.

Project U-4713A

ST-22

Mecklenburg County

CRANE SAFETY**(6-20-19)**

Comply with the manufacturer specifications and limitations applicable to the operation of any and all cranes and derricks. Prime contractors, sub-contractors, and fully operated rental companies shall comply with the current Occupational Safety and Health Administration (OSHA) regulations.

Submit all items listed below to the Engineer prior to beginning crane operations. Changes in personnel or equipment must be reported to the Engineer and all applicable items listed below must be updated and submitted prior to continuing with crane operations.

CRANE SAFETY SUBMITTAL LIST

- A. **Competent Person:** Provide the name and qualifications of the “Competent Person” responsible for crane safety and lifting operations. The named competent person will have the responsibility and authority to stop any work activity due to safety concerns.
- B. **Riggers:** Provide the qualifications and experience of the persons responsible for rigging operations. Qualifications and experience should include, but not be limited to, weight calculations, center of gravity determinations, selection and inspection of sling and rigging equipment, and safe rigging practices.
- C. **Crane Inspections:** Inspection records for all cranes shall be current and readily accessible for review upon request.
- D. **Certifications:** Crane operators shall be certified by the National Commission for the Certification of Crane Operators (NCCCO) or the National Center for Construction Education and Research (NCCER). Other approved nationally accredited programs will be considered upon request. In addition, crane operators shall have a current CDL medical card. Submit a list of crane operator(s) and include current certification for each type of crane operated (small hydraulic, large hydraulic, small lattice, large lattice) and medical evaluations for each operator.

Project U-4713A

ST-23

Mecklenburg County

GROUT FOR STRUCTURES

(12-1-17)

DESCRIPTION

This special provision addresses grout for use in pile blockouts, grout pockets, shear keys, dowel holes and recesses for structures. This provision does not apply to grout placed in post-tensioning ducts for bridge beams, girders, decks, end bent caps, or bent caps. Mix and place grout in accordance with the manufacturer's recommendations, the applicable sections of the Standard Specifications and this provision.

MATERIAL REQUIREMENTS

Unless otherwise noted on the plans, use a Type 3 Grout in accordance with Section 1003 of the Standard Specifications.

Initial setting time shall not be less than 10 minutes when tested in accordance with ASTM C266.

Construction loading and traffic loading shall not be allowed until the 3 day compressive strength is achieved.

SAMPLING AND PLACEMENT

Place and maintain components in final position until grout placement is complete and accepted. Concrete surfaces to receive grout shall be free of defective concrete, laitance, oil, grease and other foreign matter. Saturate concrete surfaces with clean water and remove excess water prior to placing grout.

BASIS OF PAYMENT

No separate payment will be made for "Grout for Structures". The cost of the material, equipment, labor, placement, and any incidentals necessary to complete the work shall be considered incidental to the structure item requiring grout.

Project U-4713A

ST-24

Mecklenburg County

SOUND BARRIER WALL**(11-30-23)****GENERAL**

This work consists of furnishing precast panels with an architectural surface treatment, structural steel, concrete, handling, transporting, fabricating, galvanizing, storing materials, furnishing erection drawings, pile excavation, backfilling, erecting and installing the sound barrier wall members and all other materials as required by the plans, Standard Specifications and this Special Provision.

Precast panels with an architectural surface treatment shall be constructed using form lining materials and patterns to match the appearance (size, shape, color, texture, pattern, and relief) of the textured finish as specified on the plans and approved by the Engineer.

The contractor is required to use the same form liner and coloration contractor to construct the precast panels with an architectural surface treatment.

The Standard Plans allow pile spacing of 10, 15 or 20 feet. Pile spacing greater than 15 feet will not be allowed for the precast concrete panels detailed in the standard plans. Provide consistent pile spacing for the entire length of the wall. Use odd pile spacing, if necessary, only at the ends of the wall and at turning points as approved by the Engineer. Architectural surface treatment shall not be applied to piles. Piles shall have a smooth, non-textured finish, and remain unstained in their natural color.

A maximum one foot drop or rise in elevation between wall sections is permitted. Elevation changes greater than one foot, if necessary, will be allowed only at the end of the wall. Changes at the top of wall elevation that result in a jagged appearance will not be allowed.

QUALIFICATIONS

Prior to beginning work, the contractor shall submit the following qualifications to the Engineer for approval:

(A) Architectural Surface Treatment Construction

The Contractor shall have a minimum of three (3) years of experience in architectural concrete surface treatment construction on similar types of projects. The Contractor shall furnish to the Engineer three (3) references who were responsible for supervision of similar projects. Include name, address, telephone number, and specific type of application.

(B) Form Liners and Coloring System

The manufacturer of form liners for the standard textured finishes and coloring system shall have at least five (5) years of experience making molds and color stains to create formed concrete surfaces to match the specified textured finish and colors. The Contractor shall schedule a pre-installation conference with a form liner manufacturer representative and the Engineer to assure understanding of simulated textured finish form liner use, color application, requirements for construction of sample panel(s), and to coordinate the work. The Contractor

Project U-4713A

ST-25

Mecklenburg County

shall be required to disclose their source of form liner manufacturer and final coloration contractor prior to the Preconstruction Conference.

ALTERNATE PILE SPACING FOR STANDARD PRECAST PANELS

As an alternate, the Contractor may submit plans for pile spacings greater than 10 feet and less than 15 feet for review and approval. The pile excavation diameter, excavation depth and reinforcing steel shall be equal to the amount shown on the existing plans for the 15 feet pile spacing. A variance in the reinforcing steel will be allowed for the length of horizontal and number of vertical reinforcement bars in the precast panel for the alternate pile spacing.

Submit two (2) sets of detailed plans for review. Include all details in the plans, including the size and spacing of required reinforcement necessary to fabricate the precast panels. Have a North Carolina registered Professional Engineer check, seal, and date the plans. After the plans are reviewed and, if necessary, corrections made, submit one set of reproducible tracings on 22" x 34" sheets to become part of the contract plans.

ALTERNATE WALL TYPE

Walls that have been assigned "Approved" or "Approved for Provisional Use" status by the Product Evaluation Program will be considered for substitution to the detailed Standard Sound Barrier Wall only when noted on the plans. Alternate wall types, piles, and piles spacing must meet the design and construction requirements of the project. Pile spacing greater than 20 feet will not be permitted. Alternate pile and wall structural stability and connection details shall conform to the current edition of the *AASHTO LRFD Bridge Design Specifications*.

Prior to submittal of Working Drawings, as described herein, submit a copy of the signed NCDOT Product Status Notification Letter and two (2) sets of preliminary plans for review and approval. Include material specifications for all components. Once preliminary plans are approved, submit Working Drawings in accordance with all applicable portions of the requirements herein, including details necessary to fabricate and construct the proposed alternate.

Have a North Carolina registered Professional Engineer check, seal, and date the plans and, when requested, provide calculations. After the plans are reviewed and, if necessary, corrections made, submit one set of reproducible tracings on 22" x 34" sheets to become part of the contract plans.

WORKING DRAWINGS

Submit precast panel casting drawings in accordance with Article 1077-2 of the Standard Specifications prior to casting. Show the inserts, method of handling, and support details used for transportation on the casting drawings. Submit fabrication drawings for approval prior to fabrication of wall components. Submit an erection plan and precast panel placing plan, including location of various heights of panels, for review and acceptance prior to fabrication of forms. Submit five (5) sets of detail drawings on 22" x 34" sheets.

Submit for review and acceptance, wall plan and elevation views and details showing overall simulated textured pattern, joint locations, and end, edge or other special conditions. The drawings

should include typical cross sections of precast panels, joints, corners, texture relief, texture size, pitch/working line, mortar joint and bed depths. If necessary, the Contractor shall revise the working drawings until the proposed form liner patterns and arrangement have been accepted by the Engineer. Working drawings should be of sufficient scale to show the detail of all textured finishes and joint patterns. Shop drawings shall be reviewed and approved prior to fabrication of form liners.

MATERIALS AND FABRICATION OF STANDARD PRECAST PANELS

Provide materials and fabricate members in accordance with the requirements of Division 10 of the *Standard Specifications*. Provide precast panels 4 inches \pm ¼ inch thick, excluding relief for a textured finish. Architectural surface treatment shall consist of a standard textured finish and a single color of stain applied to both faces of the precast panels as specified on the plans and approved by the Engineer. Relief of any texture is not to exceed an average depth of 1 inch. No textured finish or stain shall be applied on the uppermost foot of each wall segment and along the vertical edges of the panels. These areas shall have a smooth, non-textured finish, and remain in their natural concrete color.

Furnish three (3) 12" x 12" samples for approval which establish the acceptable variations in color, texture, and uniformity. After the color, texture, and uniformity of the furnished samples are approved, produce a full scale panel unit meeting design requirements. This mock-up and the furnished samples establish the standard quality for determining acceptance of the panels. When producing the final installed panels, use fine and coarse aggregate, retarder, and cement from the same source as those used in the approved sample panels.

The standard textured finish shall be constructed using form lining materials. The form liner shall be a high quality, re-useable product manufactured of high strength urethane rubber or other approved material which attaches easily to the form work system and shall not compress more than ¼ inch when concrete is poured at a rate of 10 vertical feet per hour. The form liners shall be removable without causing deterioration of the surface or underlying concrete.

The form liner shall be patterned such that long continuous horizontal or vertical lines do not occur on the finished exposed surface. The line pattern shall be random in nature and shall conceal construction joint lines.

Prior to each concrete pour, the form liners shall be clean and free of build-up. Each liner shall be visually inspected for blemishes and tears. Repairs shall be made in accordance with the manufacturer's recommendations. Repairs shall be accepted by the Engineer before being used. Form liner panels that do not perform as intended or are no longer repairable shall be replaced.

Form liners shall be securely attached to forms in accordance with the manufacturer's recommendations, with less than a ¼ inch seam. Blend form liner butt joints into the textured surface pattern and finish off the final concrete surface. Create no visible vertical or horizontal seams or conspicuous form liner butt joint marks. At locations where the form liners are joined, carefully blend to match the balance of the textured finish.

Form liners shall be installed to withstand anticipated concrete placement pressures without leakage and without causing physical or visual defects.

Project U-4713A

ST-27

Mecklenburg County

When the approved textured finish requires simulated grout pattern joints, construct grout pattern joints to simulate the appearance of mortared joints produced in laid up masonry work. Grout pattern joints shall be produced in accordance with the form liner / concrete color system manufacturer.

The Contractor shall have a technical representative from the form liner manufacturer on site for technical supervision during the installation and removal of form liners. Unless directed by the Engineer, installation and removal of form liners shall not be permitted if the technical representative is not present.

Form release agent shall be a non-staining petroleum distillate free from water, asphaltic, and other insoluble residue, or an equivalent product and shall be applied in accordance with the manufacturer's recommendations. The form release agent shall be compatible with the form liner material, the concrete coloring system, any special surface finish and in accordance with this Special Provision. Form release agent should be worked into all areas, especially pattern recesses.

All form defects in finished uncolored surface shall be filled or repaired within 48 hours of form removal. Use patching materials and procedures in accordance with the manufacturer's recommendations.

Precast concrete shall be finished in accordance with the Standard Specifications, except that curing of concrete should be done to accommodate the application of coloring and surface finish treatment.

SURFACE COLORING

All surfaces that are to receive coloring agent application shall be free of all laitance, dirt, dust, grease, efflorescence, paint, or any other foreign material prior to the application of coloring agent. Cleaning of surfaces to be accomplished by pressure washing with water set at 3,000 psi to remove laitance. The fan nozzle shall be held perpendicular to the surface at a distance of 1 to 2 feet. Sandblasting will not be permitted.

Surface coloring shall be achieved using an approved stain suitable for the purpose intended and applied in a manner consistent with the design intent of the project. Color system shall be a single color of stain in brown or gray tones as specified on the plans and approved by the Engineer. The approved sample panel shall be the basis for determining the appropriate stain application.

The coloring agent shall be a penetrating stain mix or other approved coloring system designed for exterior application on old or new concrete with field evidence of resistance to moisture, acid or alkali, mildew, mold or fungus discoloration or degradation. The coloring agent shall be breathable, allowing moisture and vapor transmission. Final coloring system and color of stain are subject to approval by the Engineer.

Application of coloring/staining agent to finished precast concrete and patches shall occur at a minimum of 30 days after form liners are removed. Maintain the concrete temperature between 40°F and 85°F during color/stain application and for 48 hours after color/stain application. Consult the manufacturer's recommendations for preparation, application, curing, and storage of coloring agents/stains. The contractor shall provide a Color Application Artist who is experienced in

producing realistic surface appearances. Treated surfaces located adjacent to exposed soil or pavement shall be temporarily covered to prevent dirt or soil splatter from rain.

Final surface shall be free of blemishes, discolorations, surface voids, and other irregularities. All patterns should be continuous without visual disruption. Linear butt joints shall be carefully blended into the approved pattern and finished off the final concrete surface. No visible vertical or horizontal seams or conspicuous form marks created by butt joining will be permitted.

Following the completion of all work, repairs of any damage made by other construction operations shall be made to the form lined and colored surfaces as directed by the Engineer.

CONSTRUCTION METHODS

Complete the final survey of existing ground profile after clearing the wall area but prior to submitting any working drawings. Submit the final groundline survey with the working drawings.

If the Department is responsible for the survey, the Engineer field verifies the existing ground profile along the sound barrier wall. Contact the Engineer to obtain the survey information. Otherwise, complete the existing ground survey prior to submittal of working drawings.

Excavate holes with the diameters shown on the plans. Perform pile excavation to the depths shown on the plans and install piles as shown on the plans or in the accepted submittals with a tolerance of ½ inch per foot from vertical. Backfill excavations with concrete after placing piles.

(A) Pile Excavation

Use equipment of adequate capacity and capable of drilling through soil and non-soil including rock, boulders, debris, man-made objects, and any other materials encountered. Blasting is not permitted to advance the excavation. Blasting for core removal is only permitted when approved by the Engineer. Dispose of drilling spoils in accordance with Section 802 of the *Standard Specifications* and as directed by the Engineer. Drilling spoils consist of all excavated material including water removed from the excavation either by pumping or drilling tools.

If unstable, caving, or sloughing soils are anticipated or encountered, stabilize excavations with either slurry or steel casing. When using slurry, submit slurry details including product information, manufacturer's recommendations for use, slurry equipment information and written approval from the slurry supplier that the mixing water is acceptable before beginning drilling. When using steel casing, use either the sectional type or one continuous corrugated or non-corrugated piece. Steel casings should consist of clean watertight steel of ample strength to withstand handling and driving stresses and the pressures imposed by concrete, earth or backfill. Use steel casings with an outside diameter equal to the hole size and a minimum wall thickness of ¼ inch.

(B) Concrete Placement

Before placing concrete, center and support the pile in the excavation and check the water inflow rate in the excavation after any pumps have been removed. If the inflow rate is less than 6 inches per half hour, remove any water and free fall the concrete into the excavation. Ensure

that concrete flows completely around the pile. If the water inflow rate is greater than 6 inches per half hour, propose a concrete placement procedure to the Engineer. The Engineer shall approve the concrete placement procedure before placing concrete.

Fill the excavation with Class A concrete in accordance with Section 1000 of the *Standard Specifications* except as modified herein. Provide concrete with a slump of 6 to 8 inches. Use an approved high-range water reducer to achieve this slump. Place concrete in a continuous manner and remove all casings.

MEASUREMENT AND PAYMENT

Sound Barrier Wall will be paid for at the unit price bid per square foot. Payment will be full compensation for work covered by this Special Provision including, but not limited to, furnishing precast panels, steel or concrete piles, miscellaneous structural steel, concrete, and all other materials; handling, transporting, fabricating, galvanizing, and storing materials; furnishing erection drawings, backfilling, pile excavation including any casing or slurry, and erecting and installing the sound barrier wall members.

The quantity of sound barrier wall to be paid for will be the actual square feet of completed and accepted wall. In any individual section of sound barrier wall or in comparably dimensioned sections, the wall height is from the bottom of the bottom panel to the top of the top panel and the width is the distance between the centerline of the piles at the ends of the section. Include the full width of the piles at the ends of the wall.

Architectural Surface Treatment will be paid at the unit price bid per square foot and will be full compensation for the architectural treatment covered by this Special Provision including, but not limited to, furnishing architectural detail drawings, sample panels; the construction, finishing, and removal of all equipment, materials, labor, and incidentals necessary for furnishing and use of all form liners to produce approved textured finish and application of approved surface coloring.

The quantity of form liner textured finish and coloring stain to be paid for will be the actual square feet of architectural surface treatment that has been incorporated into the completed and accepted work. The area of architectural surface treatment will be measured by the area of treated panels. Do not include the uppermost foot of each wall segment, panel vertical edges without architectural surface treatment, or piles in the measurement. Area of sample panels shall not be included in the measurement of architectural surface treatment.

Payment will be made under:

Pay Item	Pay Unit
Sound Barrier Wall	Square Foot
Architectural Surface Treatment (Sound Barrier Wall)	Square Foot

PROJECT SPECIAL PROVISION

(10-18-95) (Rev. 9-19-23)

Z-1

PERMITS

The Contractor's attention is directed to the following permits, which have been issued to the Department of Transportation by the authority granting the permit.

<u>PERMIT</u>	<u>AUTHORITY GRANTING THE PERMIT</u>
Dredge and Fill and/or Work in Navigable Waters (404)	U. S. Army Corps of Engineers
Water Quality (401)	Division of Environmental Management, DEQ State of North Carolina

The Contractor shall comply with all applicable permit conditions during construction of this project.

Agents of the permitting authority will periodically inspect the project for adherence to the permits.

The Contractor's attention is also directed to Articles 107-10 and 107-13 of the *Standard Specifications* and the following:

Should the Contractor propose to utilize construction methods (such as temporary structures or fill in waters and/or wetlands for haul roads, work platforms, cofferdams, etc.) not specifically identified in the permit (individual, general, or nationwide) authorizing the project it shall be the Contractor's responsibility to coordinate with the Engineer to determine what, if any, additional permit action is required. The Contractor shall also be responsible for initiating the request for the authorization of such construction method by the permitting agency. The request shall be submitted through the Engineer. The Contractor shall not utilize the construction method until it is approved by the permitting agency. The request normally takes approximately 60 days to process; however, no extensions of time or additional compensation will be granted for delays resulting from the Contractor's request for approval of construction methods not specifically identified in the permit.

Where construction moratoriums are contained in a permit condition which restricts the Contractor's activities to certain times of the year, those moratoriums will apply only to the portions of the work taking place in the restricted waters, wetlands or buffer zones, provided that activities outside those areas is done in such a manner as to not affect the restricted waters, wetlands or buffer zones.



DEPARTMENT OF THE ARMY
U.S. ARMY CORPS OF ENGINEERS, WILMINGTON DISTRICT
WILMINGTON REGULATORY OFFICE
69 DARLINGTON AVENUE
WILMINGTON NORTH CAROLINA 28403

July 3, 2024

Regulatory Division
SAW-2018-01530 NCDOT U-4713 A McKee Road Extension

Sent Via email: jmhoward@ncdot.gov

Mr. Joel Howard
PDEA Engineer
NCODT, Division 10
716 West Main Street
Albemarle, NC 28001

Dear Mr. Howard:

This letter is in response to the Pre-Construction Notification (PCN) you submitted to the Wilmington District on March 25, 2024, for a Department of the Army Nationwide permit (NWP) verification. This project has been assigned the file number SAW-2018-01530 NCDOT U-4713 A McKee Road Extension. This file number should be referenced in all correspondence concerning this project.

A review of the information provided indicates that the proposed work would include the construction of a 0.91-mile-long new roadway on new alignment known as U-4713A, McKee Road Extension. This project will construct two separate stream crossings that will include the permanent placement of fill/structures in a total of 355 linear feet (0.05 acre) and temporary dewatering activities in a total of 38 linear feet of two separate tributaries to Fourmile Creek. The project area for this determination includes a 18.81 acres area which is illustrated on the enclosed site plans/maps. The project/review area is located from the intersection of existing McKee Road and Pleasant Plains Rod (SR 3448) (at Latitude 35.092846 and Longitude -80.701184)) to the intersection of existing McKee Road with East Johns Street (SR 1009) (at Latitude 35.092846 and Longitude -80.701184) across unnamed tributaries to Fourmile Creek, in Matthews, Mecklenburg County, North Carolina.

We have determined that the proposed work is authorized by Nationwide Permit (NWP-14) pursuant to authorities under Section 404 of the Clean Water Act (33 U.S.C § 1344). The proposed work must be accomplished in strict accordance with the general permit conditions, any regional conditions, the special conditions listed in this letter, the application materials, and the enclosed plans. If the extent of the project area and/or nature of the authorized impacts to waters are modified, a revised PCN must be submitted to this office for written approval before work is initiated. Any violation of

permit conditions or deviation from your submitted plans may subject the permittee to enforcement action.

This verification is valid until March 14, 2026, unless prior to this date the subject NWP(s) is suspended, revoked, or is modified such that the activity no longer complies with the terms and conditions of this NWP. If you commence or are under contract to commence this activity before the date that the relevant NWP is modified or revoked, you will have 12 months from the date of the modification or revocation of the NWP to complete the activity under the present terms and conditions of this NWP.

Project Specific Special Conditions:

1. All work must be performed in strict compliance with (a) the description of work in the PCN and (b) the Wetlands and Surface Water Impact Permit Drawing(s) (Permit Plans) in the application dated April 3, 2020. Any modification to the description of work and/or the permit plans must be approved by the USACE prior to implementation.
2. The permittee shall require its contractors and/or agents to comply with the terms and conditions of this authorization letter in the construction and maintenance of this project and shall provide each of its contractors and/or agents associated with the construction or maintenance of this project with a copy of this authorization letter, all conditions, and any authorized modifications. A copy of this authorization letter, all conditions, and any authorized modifications, shall be available at the project site during construction and maintenance of this project.
3. The permittee agrees to implement the follow conservation measures for the NCDOT U-4713A, McKee Road Extension project in Mecklenburg County:
 - a. Tree clearing will take place from October 16 to March 31, pending federal listing of the tricolored bat (*Perimyotis subflavus*).
 - b. Tree clearing will be minimized to the maximum extent possible and limits will be clearly marked on the plans for the contractor.
 - c. No additional permanent lighting will be added to the roadway.
 - d. Temporary lighting needed for night work will be downcast and will be used in areas where trees have already been cleared.
 - e. Percussive activities such as guardrail installation will occur after tree clearing within the action area has occurred.
 - f. No blasting will occur.
4. In order to compensate for impacts associated with this permit, mitigation shall be provided in accordance with the provisions outlined on the most recent version of the attached Compensatory Mitigation Responsibility Transfer Forms. The requirements of these forms, including any special conditions listed on these forms, are hereby incorporated as special conditions of this permit authorization.

This NWP verification does not preclude the necessity to obtain any other Federal, State, or local permits, licenses, and/or certifications, which may be required.

If you have any questions related to this verification or have issues accessing documents referenced in this letter, please contact Stephen Brumagin, WRDA Project Manager of the Charlotte Field Office at (704) 798-6471, by mail at the above address, or by email at stephen.a.brumagin@usace.army.mil. Please take a moment to complete our customer satisfaction survey located at <https://regulatory.ops.usace.army.mil/customer-service-survey/>.

Sincerely,

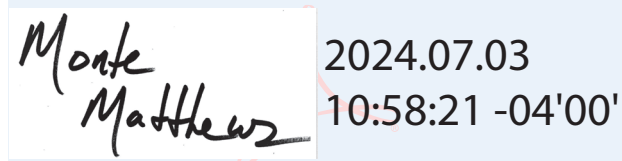
A digital signature block containing a handwritten signature and a timestamp. The signature is written in black ink and reads "Monte Matthews". To the right of the signature is a light blue rectangular box containing the date and time "2024.07.03 10:58:21 -04'00'".

Monte
Matthews

2024.07.03
10:58:21 -04'00'

Monte K. Matthews
NCDOT/WRDA Branch Chief
Wilmington District

Enclosures

Project Plans
401 WQC
NWP-14

cc (w/enclosures)

Compliance Certification Form

**File Number: SAW-2018-01530 NCDOT U-4713 A McKee Road Extension
County: Mecklenburg**

Permittee: NCDOT, Division 10, Mr. Joel Howard

Project Name: NCDOT U-4713 A McKee Road Extension

Date Verification Issued: 7/3/2024

Project Manager: Stephen Brumagin

Upon completion of the activity authorized by this permit and any mitigation required by the permit, sign this certification and return it to the following address:

**US ARMY CORPS OF ENGINEERS
Wilmington District
Attn: Stephen Brumagin
Charlotte Field Office
8430 University Executive Park Drive Suite 615
Charlotte, NC 28262
or
stephen.a.brumagin@usace.army.mil**

Please note that your permitted activity is subject to a compliance inspection by a U. S. Army Corps of Engineers representative. Failure to comply with any terms or conditions of this authorization may result in the Corps suspending, modifying or revoking the authorization and/or issuing a Class I administrative penalty, or initiating other appropriate legal action.

I hereby certify that the work, and mitigation (if applicable), authorized by the above referenced permit has been completed in accordance with the terms and conditions of the said permit including any general or specific conditions.

Date Authorized Work Started: _____ Completed: _____

Describe any deviations from permit (attach drawing(s) depicting the deviations):

***Note: The description of any deviations on this form does not constitute approval by the Corps.**

Signature of Permittee

Date

P-6

Nationwide Permit 14 Linear Transportation Projects

Effective Date: February 25, 2022 / Expiration Date: March 14, 2026
Authority: Sections 10 and 404

Activities required for crossings of waters of the United States associated with the construction, expansion, modification, or improvement of linear transportation projects (e.g., roads, highways, railways, trails, driveways, airport runways, and taxiways) in waters of the United States. For linear transportation projects in non-tidal waters, the discharge of dredged or fill material cannot cause the loss of greater than 1/2-acre of waters of the United States. For linear transportation projects in tidal waters, the discharge of dredged or fill material cannot cause the loss of greater than 1/3-acre of waters of the United States. Any stream channel modification, including bank stabilization, is limited to the minimum necessary to construct or protect the linear transportation project; such modifications must be in the immediate vicinity of the project.

This NWP also authorizes temporary structures, fills, and work, including the use of temporary mats, necessary to construct the linear transportation project. Appropriate measures must be taken to maintain normal downstream flows and minimize flooding to the maximum extent practicable, when temporary structures, work, and discharges of dredged or fill material, including cofferdams, are necessary for construction activities, access fills, or dewatering of construction sites. Temporary fills must consist of materials, and be placed in a manner, that will not be eroded by expected high flows. Temporary fills must be removed in their entirety and the affected areas returned to pre-construction elevations. The areas affected by temporary fills must be revegetated, as appropriate.

This NWP cannot be used to authorize non-linear features commonly associated with transportation projects, such as vehicle maintenance or storage buildings, parking lots, train stations, or aircraft hangars.

Notification: The permittee must submit a pre-construction notification to the district engineer prior to commencing the activity if: (1) the loss of waters of the United States exceeds 1/10-acre; or (2) there is a discharge of dredged or fill material in a special aquatic site, including wetlands. (See general condition 32.) (Authorities: Sections 10 and 404)

Note 1: For linear transportation projects crossing a single waterbody more than one time at separate and distant locations, or multiple waterbodies at separate and distant locations, each crossing is considered a single and complete project for purposes of NWP authorization. Linear transportation projects must comply with 33 CFR 330.6(d).

Note 2: Some discharges of dredged or fill material for the construction of farm roads or forest roads, or temporary roads for moving mining equipment, may qualify for an exemption under Section 404(f) of the Clean Water Act (see 33 CFR 323.4).

Note 3: For NWP 14 activities that require pre-construction notification, the PCN must include any other NWP(s), regional general permit(s), or individual permit(s) used or intended to be used to authorize any part of the proposed project or any related activity, including other separate and distant crossings that require Department of the Army authorization but do not require pre-construction notification (see paragraph (b)(4) of general condition 32). The district engineer will evaluate the PCN in accordance with Section D, "District Engineer's Decision." The district engineer may require mitigation to ensure that the authorized activity results in no

more than minimal individual and cumulative adverse environmental effects (see general condition 23).

GENERAL CONDITIONS

Note: To qualify for NWP authorization, the prospective permittee must comply with the following general conditions, as applicable, in addition to any regional or case-specific conditions imposed by the division engineer or district engineer. Prospective permittees should contact the appropriate Corps district office to determine if regional conditions have been imposed on an NWP. Prospective permittees should also contact the appropriate Corps district office to determine the status of Clean Water Act Section 401 water quality certification and/or Coastal Zone Management Act consistency for an NWP. Every person who may wish to obtain permit authorization under one or more NWPs, or who is currently relying on an existing or prior permit authorization under one or more NWPs, has been and is on notice that all of the provisions of 33 CFR 330.1 through 330.6 apply to every NWP authorization. Note especially 33 CFR 330.5 relating to the modification, suspension, or revocation of any NWP authorization.

1. Navigation.

(a) No activity may cause more than a minimal adverse effect on navigation.

(b) Any safety lights and signals prescribed by the U.S. Coast Guard, through regulations or otherwise, must be installed and maintained at the permittee's expense on authorized facilities in navigable waters of the United States.

(c) The permittee understands and agrees that, if future operations by the United States require the removal, relocation, or other alteration, of the structure or work herein authorized, or if, in the opinion of the Secretary of the Army or his authorized representative, said structure or work shall cause unreasonable obstruction to the free navigation of the navigable waters, the permittee will be required, upon due notice from the Corps of Engineers, to remove, relocate, or alter the structural work or obstructions caused thereby, without expense to the United States. No claim shall be made against the United States on account of any such removal or alteration.

2. Aquatic Life Movements. No activity may substantially disrupt the necessary life cycle movements of those species of aquatic life indigenous to the waterbody, including those species that normally migrate through the area, unless the activity's primary purpose is to impound water. All permanent and temporary crossings of waterbodies shall be suitably culverted, bridged, or otherwise designed and constructed to maintain low flows to sustain the movement of those aquatic species. If a bottomless culvert cannot be used, then the crossing should be designed and constructed to minimize adverse effects to aquatic life movements.

3. Spawning Areas. Activities in spawning areas during spawning seasons must be avoided to the maximum extent practicable. Activities that result in the physical destruction (e.g., through excavation, fill, or downstream smothering by substantial turbidity) of an important spawning area are not authorized.

4. Migratory Bird Breeding Areas. Activities in waters of the United States that serve as breeding areas for migratory birds must be avoided to the maximum extent practicable.

P-8

5. **Shellfish Beds.** No activity may occur in areas of concentrated shellfish populations, unless the activity is directly related to a shellfish harvesting activity authorized by NWP 4 and 48, or is a shellfish seeding or habitat restoration activity authorized by NWP 27.

6. **Suitable Material.** No activity may use unsuitable material (e.g., trash, debris, car bodies, asphalt, etc.). Material used for construction or discharged must be free from toxic pollutants in toxic amounts (see section 307 of the Clean Water Act).

7. **Water Supply Intakes.** No activity may occur in the proximity of a public water supply intake, except where the activity is for the repair or improvement of public water supply intake structures or adjacent bank stabilization.

8. **Adverse Effects from Impoundments.** If the activity creates an impoundment of water, adverse effects to the aquatic system due to accelerating the passage of water, and/or restricting its flow must be minimized to the maximum extent practicable.

9. **Management of Water Flows.** To the maximum extent practicable, the pre-construction course, condition, capacity, and location of open waters must be maintained for each activity, including stream channelization, storm water management activities, and temporary and permanent road crossings, except as provided below. The activity must be constructed to withstand expected high flows. The activity must not restrict or impede the passage of normal or high flows unless the primary purpose of the activity is to impound water or manage high flows. The activity may alter the pre-construction course, condition, capacity, and location of open waters if it benefits the aquatic environment (e.g., stream restoration or relocation activities).

10. **Fills Within 100-Year Floodplains.** The activity must comply with applicable FEMA-approved state or local floodplain management requirements.

11. **Equipment.** Heavy equipment working in wetlands or mudflats must be placed on mats, or other measures must be taken to minimize soil disturbance.

12. **Soil Erosion and Sediment Controls.** Appropriate soil erosion and sediment controls must be used and maintained in effective operating condition during construction, and all exposed soil and other fills, as well as any work below the ordinary high water mark or high tide line, must be permanently stabilized at the earliest practicable date. Permittees are encouraged to perform work within waters of the United States during periods of low-flow or no-flow, or during low tides.

13. **Removal of Structures and Fills.** Temporary structures must be removed, to the maximum extent practicable, after their use has been discontinued. Temporary fills must be removed in their entirety and the affected areas returned to pre-construction elevations. The affected areas must be revegetated, as appropriate.

14. **Proper Maintenance.** Any authorized structure or fill shall be properly maintained, including maintenance to ensure public safety and compliance with applicable NWP general conditions, as well as any activity-specific conditions added by the district engineer to an NWP authorization.

15. **Single and Complete Project.** The activity must be a single and complete project. The same NWP cannot be used more than once for the same single and complete project.

16. **Wild and Scenic Rivers.**

(a) No NWP activity may occur in a component of the National Wild and Scenic River System, or in a river officially designated by Congress as a “study river” for possible inclusion in the system while the river is in an official study status, unless the appropriate Federal agency with direct management responsibility for such river, has determined in writing that the proposed activity will not adversely affect the Wild and Scenic River designation or study status.

(b) If a proposed NWP activity will occur in a component of the National Wild and Scenic River System, or in a river officially designated by Congress as a “study river” for possible inclusion in the system while the river is in an official study status, the permittee must submit a pre-construction notification (see general condition 32). The district engineer will coordinate the PCN with the Federal agency with direct management responsibility for that river. Permittees shall not begin the NWP activity until notified by the district engineer that the Federal agency with direct management responsibility for that river has determined in writing that the proposed NWP activity will not adversely affect the Wild and Scenic River designation or study status.

(c) Information on Wild and Scenic Rivers may be obtained from the appropriate Federal land management agency responsible for the designated Wild and Scenic River or study river (e.g., National Park Service, U.S. Forest Service, Bureau of Land Management, U.S. Fish and Wildlife Service). Information on these rivers is also available at: <http://www.rivers.gov/>.

17. **Tribal Rights.** No activity or its operation may impair reserved tribal rights, including, but not limited to, reserved water rights and treaty fishing and hunting rights.

18. **Endangered Species.**

(a) No activity is authorized under any NWP which is likely to directly or indirectly jeopardize the continued existence of a threatened or endangered species or a species proposed for such designation, as identified under the Federal Endangered Species Act (ESA), or which will directly or indirectly destroy or adversely modify the critical habitat of such species. No activity is authorized under any NWP which “may affect” a listed species or critical habitat unless ESA section 7 consultation addressing the consequences of the proposed activity on listed species or critical habitat has been completed. See 50 CFR 402.02 for the definition of “effects of the action” for the purposes of ESA section 7 consultation, as well as 50 CFR 402.17, which provides further explanation under ESA section 7 regarding “activities that are reasonably certain to occur” and “consequences caused by the proposed action.”

(b) Federal agencies should follow their own procedures for complying with the requirements of the ESA (see 33 CFR 330.4(f)(1)). If pre-construction notification is required for the proposed activity, the Federal permittee must provide the district engineer with the appropriate documentation to demonstrate compliance with those requirements. The district engineer will verify that the appropriate documentation has been submitted. If the appropriate documentation has not been submitted, additional ESA section 7 consultation may be necessary for the activity and the respective federal agency would be responsible for fulfilling its obligation under section 7 of the ESA.

(c) Non-federal permittees must submit a pre-construction notification to the district engineer if any listed species or designated critical habitat might be affected or is in the vicinity of the activity, or if the activity is located in designated critical habitat, and shall not begin work on the activity until notified by the district engineer that the requirements of the ESA have been satisfied and that the activity is authorized. For activities that might affect Federally-listed

P-10

endangered or threatened species or designated critical habitat, the pre-construction notification must include the name(s) of the endangered or threatened species that might be affected by the proposed activity or that utilize the designated critical habitat that might be affected by the proposed activity. The district engineer will determine whether the proposed activity “may affect” or will have “no effect” to listed species and designated critical habitat and will notify the non-Federal applicant of the Corps’ determination within 45 days of receipt of a complete pre-construction notification. For activities where the non-Federal applicant has identified listed species or critical habitat that might be affected or is in the vicinity of the activity, and has so notified the Corps, the applicant shall not begin work until the Corps has provided notification that the proposed activity will have “no effect” on listed species or critical habitat, or until ESA section 7 consultation has been completed. If the non-Federal applicant has not heard back from the Corps within 45 days, the applicant must still wait for notification from the Corps.

(d) As a result of formal or informal consultation with the FWS or NMFS the district engineer may add species specific permit conditions to the NWP.

(e) Authorization of an activity by an NWP does not authorize the “take” of a threatened or endangered species as defined under the ESA. In the absence of separate authorization (e.g., an ESA Section 10 Permit, a Biological Opinion with “incidental take” provisions, etc.) from the FWS or the NMFS, the Endangered Species Act prohibits any person subject to the jurisdiction of the United States to take a listed species, where “take” means to harass, harm, pursue, hunt, shoot, wound, kill, trap, capture, or collect, or to attempt to engage in any such conduct. The word “harm” in the definition of “take” means an act which actually kills or injures wildlife. Such an act may include significant habitat modification or degradation where it actually kills or injures wildlife by significantly impairing essential behavioral patterns, including breeding, feeding or sheltering.

(f) If the non-federal permittee has a valid ESA section 10(a)(1)(B) incidental take permit with an approved Habitat Conservation Plan for a project or a group of projects that includes the proposed NWP activity, the non-federal applicant should provide a copy of that ESA section 10(a)(1)(B) permit with the PCN required by paragraph (c) of this general condition. The district engineer will coordinate with the agency that issued the ESA section 10(a)(1)(B) permit to determine whether the proposed NWP activity and the associated incidental take were considered in the internal ESA section 7 consultation conducted for the ESA section 10(a)(1)(B) permit. If that coordination results in concurrence from the agency that the proposed NWP activity and the associated incidental take were considered in the internal ESA section 7 consultation for the ESA section 10(a)(1)(B) permit, the district engineer does not need to conduct a separate ESA section 7 consultation for the proposed NWP activity. The district engineer will notify the non-federal applicant within 45 days of receipt of a complete pre-construction notification whether the ESA section 10(a)(1)(B) permit covers the proposed NWP activity or whether additional ESA section 7 consultation is required.

(g) Information on the location of threatened and endangered species and their critical habitat can be obtained directly from the offices of the FWS and NMFS or their worldwide Web pages at <http://www.fws.gov/> or <http://www.fws.gov/ipac> and <http://www.nmfs.noaa.gov/pr/species/esa/> respectively.

19. **Migratory Birds and Bald and Golden Eagles.** The permittee is responsible for ensuring that an action authorized by NWP complies with the Migratory Bird Treaty Act and the Bald and Golden Eagle Protection Act. The permittee is responsible for contacting the appropriate local office of the U.S. Fish and Wildlife Service to determine what measures, if any, are

necessary or appropriate to reduce adverse effects to migratory birds or eagles, including whether "incidental take" permits are necessary and available under the Migratory Bird Treaty Act or Bald and Golden Eagle Protection Act for a particular activity.

20. **Historic Properties.**

(a) No activity is authorized under any NWP which may have the potential to cause effects to properties listed, or eligible for listing, in the National Register of Historic Places until the requirements of Section 106 of the National Historic Preservation Act (NHPA) have been satisfied.

(b) Federal permittees should follow their own procedures for complying with the requirements of section 106 of the National Historic Preservation Act (see 33 CFR 330.4(g)(1)). If pre-construction notification is required for the proposed NWP activity, the Federal permittee must provide the district engineer with the appropriate documentation to demonstrate compliance with those requirements. The district engineer will verify that the appropriate documentation has been submitted. If the appropriate documentation is not submitted, then additional consultation under section 106 may be necessary. The respective federal agency is responsible for fulfilling its obligation to comply with section 106.

(c) Non-federal permittees must submit a pre-construction notification to the district engineer if the NWP activity might have the potential to cause effects to any historic properties listed on, determined to be eligible for listing on, or potentially eligible for listing on the National Register of Historic Places, including previously unidentified properties. For such activities, the pre-construction notification must state which historic properties might have the potential to be affected by the proposed NWP activity or include a vicinity map indicating the location of the historic properties or the potential for the presence of historic properties. Assistance regarding information on the location of, or potential for, the presence of historic properties can be sought from the State Historic Preservation Officer, Tribal Historic Preservation Officer, or designated tribal representative, as appropriate, and the National Register of Historic Places (see 33 CFR 330.4(g)). When reviewing pre-construction notifications, district engineers will comply with the current procedures for addressing the requirements of section 106 of the National Historic Preservation Act. The district engineer shall make a reasonable and good faith effort to carry out appropriate identification efforts commensurate with potential impacts, which may include background research, consultation, oral history interviews, sample field investigation, and/or field survey. Based on the information submitted in the PCN and these identification efforts, the district engineer shall determine whether the proposed NWP activity has the potential to cause effects on the historic properties. Section 106 consultation is not required when the district engineer determines that the activity does not have the potential to cause effects on historic properties (see 36 CFR 800.3(a)). Section 106 consultation is required when the district engineer determines that the activity has the potential to cause effects on historic properties. The district engineer will conduct consultation with consulting parties identified under 36 CFR 800.2(c) when he or she makes any of the following effect determinations for the purposes of section 106 of the NHPA: no historic properties affected, no adverse effect, or adverse effect.

(d) Where the non-Federal applicant has identified historic properties on which the proposed NWP activity might have the potential to cause effects and has so notified the Corps, the non-Federal applicant shall not begin the activity until notified by the district engineer either that the activity has no potential to cause effects to historic properties or that NHPA section 106 consultation has been completed. For non-federal permittees, the district engineer will notify the prospective permittee within 45 days of receipt of a complete pre-construction notification whether NHPA section 106 consultation is required. If NHPA section 106 consultation is

P-12

required, the district engineer will notify the non-Federal applicant that he or she cannot begin the activity until section 106 consultation is completed. If the non-Federal applicant has not heard back from the Corps within 45 days, the applicant must still wait for notification from the Corps.

(e) Prospective permittees should be aware that section 110k of the NHPA (54 U.S.C. 306113) prevents the Corps from granting a permit or other assistance to an applicant who, with intent to avoid the requirements of section 106 of the NHPA, has intentionally significantly adversely affected a historic property to which the permit would relate, or having legal power to prevent it, allowed such significant adverse effect to occur, unless the Corps, after consultation with the Advisory Council on Historic Preservation (ACHP), determines that circumstances justify granting such assistance despite the adverse effect created or permitted by the applicant. If circumstances justify granting the assistance, the Corps is required to notify the ACHP and provide documentation specifying the circumstances, the degree of damage to the integrity of any historic properties affected, and proposed mitigation. This documentation must include any views obtained from the applicant, SHPO/THPO, appropriate Indian tribes if the undertaking occurs on or affects historic properties on tribal lands or affects properties of interest to those tribes, and other parties known to have a legitimate interest in the impacts to the permitted activity on historic properties.

21. **Discovery of Previously Unknown Remains and Artifacts.** Permittees that discover any previously unknown historic, cultural or archeological remains and artifacts while accomplishing the activity authorized by NWP, they must immediately notify the district engineer of what they have found, and to the maximum extent practicable, avoid construction activities that may affect the remains and artifacts until the required coordination has been completed. The district engineer will initiate the Federal, Tribal, and state coordination required to determine if the items or remains warrant a recovery effort or if the site is eligible for listing in the National Register of Historic Places.

22. **Designated Critical Resource Waters.** Critical resource waters include, NOAA-managed marine sanctuaries and marine monuments, and National Estuarine Research Reserves. The district engineer may designate, after notice and opportunity for public comment, additional waters officially designated by a state as having particular environmental or ecological significance, such as outstanding national resource waters or state natural heritage sites. The district engineer may also designate additional critical resource waters after notice and opportunity for public comment.

(a) Discharges of dredged or fill material into waters of the United States are not authorized by NWPs 7, 12, 14, 16, 17, 21, 29, 31, 35, 39, 40, 42, 43, 44, 49, 50, 51, 52, 57 and 5258 for any activity within, or directly affecting, critical resource waters, including wetlands adjacent to such waters.

(b) For NWPs 3, 8, 10, 13, 15, 18, 19, 22, 23, 25, 27, 28, 30, 33, 34, 36, 37, 38, and 54, notification is required in accordance with general condition 32, for any activity proposed by permittees in the designated critical resource waters including wetlands adjacent to those waters. The district engineer may authorize activities under these NWPs only after she or he determines that the impacts to the critical resource waters will be no more than minimal.

23. **Mitigation.** The district engineer will consider the following factors when determining appropriate and practicable mitigation necessary to ensure that the individual and cumulative adverse environmental effects are no more than minimal:

P-13

(a) The activity must be designed and constructed to avoid and minimize adverse effects, both temporary and permanent, to waters of the United States to the maximum extent practicable at the project site (*i.e.*, on site).

(b) Mitigation in all its forms (avoiding, minimizing, rectifying, reducing, or compensating for resource losses) will be required to the extent necessary to ensure that the individual and cumulative adverse environmental effects are no more than minimal.

(c) Compensatory mitigation at a minimum one-for-one ratio will be required for all wetland losses that exceed 1/10-acre and require pre-construction notification, unless the district engineer determines in writing that either some other form of mitigation would be more environmentally appropriate or the adverse environmental effects of the proposed activity are no more than minimal, and provides an activity-specific waiver of this requirement. For wetland losses of 1/10-acre or less that require pre-construction notification, the district engineer may determine on a case-by-case basis that compensatory mitigation is required to ensure that the activity results in only minimal adverse environmental effects.

(d) Compensatory mitigation at a minimum one-for-one ratio will be required for all losses of stream bed that exceed 1/103/100-acre and require pre-construction notification, unless the district engineer determines in writing that either some other form of mitigation would be more environmentally appropriate or the adverse environmental effects of the proposed activity are no more than minimal, and provides an activity-specific waiver of this requirement. This compensatory mitigation requirement may be satisfied through the restoration or enhancement of riparian areas next to streams in accordance with paragraph (e) of this general condition. For losses of stream bed of 1/103/100-acre or less that require pre-construction notification, the district engineer may determine on a case-by-case basis that compensatory mitigation is required to ensure that the activity results in only minimal adverse environmental effects. Compensatory mitigation for losses of streams should be provided, if practicable, through stream rehabilitation, enhancement, or preservation since streams are difficult-to-replace resources (see 33 CFR 332.3(e)(3)).

(e) Compensatory mitigation plans for NWP activities in or near streams or other open waters will normally include a requirement for the restoration or enhancement, maintenance, and legal protection (e.g., conservation easements) of riparian areas next to open waters. In some cases, the restoration or maintenance/protection of riparian areas may be the only compensatory mitigation required. If restoring riparian areas involves planting vegetation, only native species should be planted. The width of the required riparian area will address documented water quality or aquatic habitat loss concerns. Normally, the riparian area will be 25 to 50 feet wide on each side of the stream, but the district engineer may require slightly wider riparian areas to address documented water quality or habitat loss concerns. If it is not possible to restore or maintain/protect a riparian area on both sides of a stream, or if the waterbody is a lake or coastal waters, then restoring or maintaining/protecting a riparian area along a single bank or shoreline may be sufficient. Where both wetlands and open waters exist on the project site, the district engineer will determine the appropriate compensatory mitigation (e.g., riparian areas and/or wetlands compensation) based on what is best for the aquatic environment on a watershed basis. In cases where riparian areas are determined to be the most appropriate form of minimization or compensatory mitigation, the district engineer may waive or reduce the requirement to provide wetland compensatory mitigation for wetland losses.

P-14

(f) Compensatory mitigation projects provided to offset losses of aquatic resources must comply with the applicable provisions of 33 CFR part 332.

(1) The prospective permittee is responsible for proposing an appropriate compensatory mitigation option if compensatory mitigation is necessary to ensure that the activity results in no more than minimal adverse environmental effects. For the NWP, the preferred mechanism for providing compensatory mitigation is mitigation bank credits or in-lieu fee program credits (see 33 CFR 332.3(b)(2) and (3)). However, if an appropriate number and type of mitigation bank or in-lieu credits are not available at the time the PCN is submitted to the district engineer, the district engineer may approve the use of permittee-responsible mitigation.

(2) The amount of compensatory mitigation required by the district engineer must be sufficient to ensure that the authorized activity results in no more than minimal individual and cumulative adverse environmental effects (see 33 CFR 330.1(e)(3)). (See also 33 CFR 332.3(f)).

(3) Since the likelihood of success is greater and the impacts to potentially valuable uplands are reduced, aquatic resource restoration should be the first compensatory mitigation option considered for permittee-responsible mitigation.

(4) If permittee-responsible mitigation is the proposed option, the prospective permittee is responsible for submitting a mitigation plan. A conceptual or detailed mitigation plan may be used by the district engineer to make the decision on the NWP verification request, but a final mitigation plan that addresses the applicable requirements of 33 CFR 332.4(c)(2) through (14) must be approved by the district engineer before the permittee begins work in waters of the United States, unless the district engineer determines that prior approval of the final mitigation plan is not practicable or not necessary to ensure timely completion of the required compensatory mitigation (see 33 CFR 332.3(k)(3)). If permittee-responsible mitigation is the proposed option, and the proposed compensatory mitigation site is located on land in which another federal agency holds an easement, the district engineer will coordinate with that federal agency to determine if proposed compensatory mitigation project is compatible with the terms of the easement.

(5) If mitigation bank or in-lieu fee program credits are the proposed option, the mitigation plan needs to address only the baseline conditions at the impact site and the number of credits to be provided (see 33 CFR 332.4(c)(1)(ii)).

(6) Compensatory mitigation requirements (e.g., resource type and amount to be provided as compensatory mitigation, site protection, ecological performance standards, monitoring requirements) may be addressed through conditions added to the NWP authorization, instead of components of a compensatory mitigation plan (see 33 CFR 332.4(c)(1)(ii)).

(g) Compensatory mitigation will not be used to increase the acreage losses allowed by the acreage limits of the NWPs. For example, if an NWP has an acreage limit of 1/2-acre, it cannot be used to authorize any NWP activity resulting in the loss of greater than 1/2-acre of waters of the United States, even if compensatory mitigation is provided that replaces or restores some of the lost waters. However, compensatory mitigation can and should be used, as necessary, to ensure that an NWP activity already meeting the established acreage limits also satisfies the no more than minimal impact requirement for the NWPs.

(h) Permittees may propose the use of mitigation banks, in-lieu fee programs, or permittee-responsible mitigation. When developing a compensatory mitigation proposal, the permittee must consider appropriate and practicable options consistent with the framework at 33 CFR 332.3(b). For activities resulting in the loss of marine or estuarine resources, permittee-responsible mitigation may be environmentally preferable if there are no mitigation banks or in-lieu fee programs in the area that have marine or estuarine credits available for sale or transfer to the permittee. For permittee-responsible mitigation, the special conditions of the NWP verification must clearly indicate the party or parties responsible for the implementation and performance of the compensatory mitigation project, and, if required, its long-term management.

(i) Where certain functions and services of waters of the United States are permanently adversely affected by a regulated activity, such as discharges of dredged or fill material into waters of the United States that will convert a forested or scrub-shrub wetland to an herbaceous wetland in a permanently maintained utility line right-of-way, mitigation may be required to reduce the adverse environmental effects of the activity to the no more than minimal level.

24. **Safety of Impoundment Structures.** To ensure that all impoundment structures are safely designed, the district engineer may require non-Federal applicants to demonstrate that the structures comply with established state or federal, dam safety criteria or have been designed by qualified persons. The district engineer may also require documentation that the design has been independently reviewed by similarly qualified persons, and appropriate modifications made to ensure safety.

25. **Water Quality.**

(a) Where the certifying authority (state, authorized tribe, or EPA, as appropriate) has not previously certified compliance of an NWP with CWA section 401, a CWA section 401 water quality certification for the proposed discharge must be obtained or waived (see 33 CFF 330.4(c)). If the permittee cannot comply with all of the conditions of a water quality certification previously issued by certifying authority for the issuance of the NWP, then the permittee must obtain a water quality certification or waiver for the proposed discharge in order for the activity to be authorized by an NWP.

(b) If the NWP activity requires pre-construction notification and the certifying authority has not previously certified compliance of an NWP with CWA section 401, the proposed discharge is not authorized by an NWP until water quality certification is obtained or waived. If the certifying authority issues a water quality certification for the proposed discharge, the permittee must submit a copy of the certification to the district engineer. The discharge is not authorized by an NWP until the district engineer has notified the permittee that the water quality certification requirement has been satisfied by the issuance of a water quality certification or a waiver.

(c) The district engineer or certifying authority may require additional water quality management measures to ensure that the authorized activity does not result in more than minimal degradation of water quality.

26. **Coastal Zone Management.** In coastal states where an NWP has not previously received a state coastal zone management consistency concurrence, an individual state coastal zone management consistency concurrence must be obtained, or a presumption of concurrence must occur (see 33 CFR 330.4(d)). If the permittee cannot comply with all of the conditions of a

coastal zone management consistency concurrence previously issued by the state, then the permittee must obtain an individual coastal zone management consistency concurrence or presumption of concurrence in order for the activity to be authorized by an NWP. The district engineer or a state may require additional measures to ensure that the authorized activity is consistent with state coastal zone management requirements.

27. **Regional and Case-By-Case Conditions.** The activity must comply with any regional conditions that may have been added by the Division Engineer (see 33 CFR 330.4(e)) and with any case specific conditions added by the Corps or by the state, Indian Tribe, or U.S. EPA in its CWA section 401 Water Quality Certification, or by the state in its Coastal Zone Management Act consistency determination.

28. **Use of Multiple Nationwide Permits.** The use of more than one NWP for a single and complete project is authorized, subject to the following restrictions:

(a) If only one of the NWPs used to authorize the single and complete project has a specified acreage limit, the acreage loss of waters of the United States cannot exceed the acreage limit of the NWP with the highest specified acreage limit. For example, if a road crossing over tidal waters is constructed under NWP 14, with associated bank stabilization authorized by NWP 13, the maximum acreage loss of waters of the United States for the total project cannot exceed 1/3-acre.

(b) If one or more of the NWPs used to authorize the single and complete project has specified acreage limits, the acreage loss of waters of the United States authorized by those NWPs cannot exceed their respective specified acreage limits. For example, if a commercial development is constructed under NWP 39, and the single and complete project includes the filling of an upland ditch authorized by NWP 46, the maximum acreage loss of waters of the United States for the commercial development under NWP 39 cannot exceed 1/2-acre, and the total acreage loss of waters of United States due to the NWP 39 and 46 activities cannot exceed 1 acre.

29. **Transfer of Nationwide Permit Verifications.** If the permittee sells the property associated with a nationwide permit verification, the permittee may transfer the nationwide permit verification to the new owner by submitting a letter to the appropriate Corps district office to validate the transfer. A copy of the nationwide permit verification must be attached to the letter, and the letter must contain the following statement and signature:

“When the structures or work authorized by this nationwide permit are still in existence at the time the property is transferred, the terms and conditions of this nationwide permit, including any special conditions, will continue to be binding on the new owner(s) of the property. To validate the transfer of this nationwide permit and the associated liabilities associated with compliance with its terms and conditions, have the transferee sign and date below.”

(Transferee)

(Date)

30. **Compliance Certification.** Each permittee who receives an NWP verification letter from the Corps must provide a signed certification documenting completion of the authorized activity and implementation of any required compensatory mitigation. The success of any required permittee-responsible mitigation, including the achievement of ecological performance

P-17

standards, will be addressed separately by the district engineer. The Corps will provide the permittee the certification document with the NWP verification letter. The certification document will include:

- (a) A statement that the authorized activity was done in accordance with the NWP authorization, including any general, regional, or activity-specific conditions;
- (b) A statement that the implementation of any required compensatory mitigation was completed in accordance with the permit conditions. If credits from a mitigation bank or in-lieu fee program are used to satisfy the compensatory mitigation requirements, the certification must include the documentation required by 33 CFR 332.3(l)(3) to confirm that the permittee secured the appropriate number and resource type of credits; and
- (c) The signature of the permittee certifying the completion of the activity and mitigation. The completed certification document must be submitted to the district engineer within 30 days of completion of the authorized activity or the implementation of any required compensatory mitigation, whichever occurs later.

31. **Activities Affecting Structures or Works Built by the United States.** If an NWP activity also requires permission from the Corps pursuant to 33 U.S.C. 408 because it will alter or temporarily or permanently occupy or use a U.S. Army Corps of Engineers (USACE) federally authorized Civil Works project (a "USACE project"), the prospective permittee must submit a pre-construction notification. See paragraph (b)(10) of general condition 32. An activity that requires section 408 permission and/or review is not authorized by an NWP until the appropriate Corps office issues the section 408 permission or completes its review to alter, occupy, or use the USACE project, and the district engineer issues a written NWP verification.

32. **Pre-Construction Notification.**

(a) *Timing.* Where required by the terms of the NWP, the permittee must notify the district engineer by submitting a pre-construction notification (PCN) as early as possible. The district engineer must determine if the PCN is complete within 30 calendar days of the date of receipt and, if the PCN is determined to be incomplete, notify the prospective permittee within that 30 day period to request the additional information necessary to make the PCN complete. The request must specify the information needed to make the PCN complete. As a general rule, district engineers will request additional information necessary to make the PCN complete only once. However, if the prospective permittee does not provide all of the requested information, then the district engineer will notify the prospective permittee that the PCN is still incomplete and the PCN review process will not commence until all of the requested information has been received by the district engineer. The prospective permittee shall not begin the activity until either:

- (1) He or she is notified in writing by the district engineer that the activity may proceed under the NWP with any special conditions imposed by the district or division engineer; or
- (2) 45 calendar days have passed from the district engineer's receipt of the complete PCN and the prospective permittee has not received written notice from the district or division engineer. However, if the permittee was required to notify the Corps pursuant to general condition 18 that listed species or critical habitat might be affected or are in the vicinity of the activity, or to notify the Corps pursuant to general condition 20 that the activity might have the potential to cause effects to historic properties, the permittee cannot begin the activity until receiving written notification from the Corps that there is "no

P-18

effect” on listed species or “no potential to cause effects” on historic properties, or that any consultation required under Section 7 of the Endangered Species Act (see 33 CFR 330.4(f)) and/or section 106 of the National Historic Preservation Act (see 33 CFR 330.4(g)) has been completed. If the proposed activity requires a written waiver to exceed specified limits of an NWP, the permittee may not begin the activity until the district engineer issues the waiver. If the district or division engineer notifies the permittee in writing that an individual permit is required within 45 calendar days of receipt of a complete PCN, the permittee cannot begin the activity until an individual permit has been obtained. Subsequently, the permittee’s right to proceed under the NWP may be modified, suspended, or revoked only in accordance with the pr set forth in 33 CFR 330.5(d)(2).

(b) *Contents of Pre-Construction Notification:* The PCN must be in writing and include the following information:

- (1) Name, address and telephone numbers of the prospective permittee;
- (2) Location of the proposed activity;
- (3) Identify the specific NWP or NWP(s) the prospective permittee wants to use to authorize the proposed activity;
- (4)
 - (i) A description of the proposed activity; the activity’s purpose; direct and indirect adverse environmental effects the activity would cause, including the anticipated amount of loss of wetlands, other special aquatic sites, and other waters expected to result from the NWP activity, in acres, linear feet, or other appropriate unit of measure; a description of any proposed mitigation measures intended to reduce the adverse environmental effects caused by the proposed activity; and any other NWP(s), regional general permit(s), or individual permit(s) used or intended to be used to authorize any part of the proposed project or any related activity, including other separate and distant crossings for linear projects that require Department of the Army authorization but do not require pre-construction notification. The description of the proposed activity and any proposed mitigation measures should be sufficiently detailed to allow the district engineer to determine that the adverse environmental effects of the activity will be no more than minimal and to determine the need for compensatory mitigation or other mitigation measures.
 - (ii) For linear projects where one or more single and complete crossings require pre-construction notification, the PCN must include the quantity of anticipated losses of wetlands, other special aquatic sites, and other waters for each single and complete crossing of those wetlands, other special aquatic sites, and other waters (including those single and complete crossings authorized by an NWP but do not require PCNs). This information will be used by the district engineer to evaluate the cumulative adverse environmental effects of the proposed linear project and does not change those non-PCN NWP activities into NWP PCNs.
 - (iii) Sketches should be provided when necessary to show that the activity complies with the terms of the NWP. (Sketches usually clarify the activity and when provided results in a quicker decision. Sketches should contain sufficient detail to provide an illustrative description of the proposed activity (e.g., a conceptual plan), but do not need to be detailed engineering plans).

P-19

(5) The PCN must include a delineation of wetlands, other special aquatic sites, and other waters, such as lakes and ponds, and perennial and intermittent streams, on the project site. Wetland delineations must be prepared in accordance with the current method required by the Corps. The permittee may ask the Corps to delineate the special aquatic sites and other waters on the project site, but there may be a delay if the Corps does the delineation, especially if the project site is large or contains many wetlands, other special aquatic sites, and other waters. Furthermore, the 45-day period will not start until the delineation has been submitted to or completed by the Corps, as appropriate.

(6) If the proposed activity will result in the loss of greater than 1/10-acre of wetlands or 3/100-acre of stream bed and a PCN is required, the prospective permittee must submit a statement describing how the mitigation requirement will be satisfied, or explaining why the adverse environmental effects are no more than minimal and why compensatory mitigation should not be required. As an alternative, the prospective permittee may submit a conceptual or detailed mitigation plan.

(7) For non-federal permittees, if any listed species (or species proposed for listing) or designated critical habitat (or critical habitat proposed for such designation) might be affected or is in the vicinity of the activity, or if the activity is located in designated critical habitat (or critical habitat proposed for such designation), the PCN must include the name(s) of those endangered or threatened species (or species proposed for listing) that might be affected by the proposed activity or utilize the designated critical habitat (or critical habitat proposed for such designation) that might be affected by the proposed activity. For NWP activities that require pre-construction notification, Federal permittees must provide documentation demonstrating compliance with the Endangered Species Act.

(8) For non-federal permittees, if the NWP activity might have the potential to cause effects to a historic property listed on, determined to be eligible for listing on, or potentially eligible for listing on, the National Register of Historic Places, the PCN must state which historic property might have the potential to be affected by the proposed activity or include a vicinity map indicating the location of the historic property. For NWP activities that require pre-construction notification, Federal permittees must provide documentation demonstrating compliance with section 106 of the National Historic Preservation Act.

(9) For an activity that will occur in a component of the National Wild and Scenic River System, or in a river officially designated by Congress as a “study river” for possible inclusion in the system while the river is in an official study status, the PCN must identify the Wild and Scenic River or the “study river” (see general condition 16); and

(10) For an NWP activity that requires permission from, or review by, the Corps pursuant to 33 U.S.C. 408 because it will alter or temporarily or permanently occupy or use a U.S. Army Corps of Engineers federally authorized civil works project, the pre-construction notification must include a statement confirming that the project proponent has submitted a written request for section 408 permission from, or review by, the Corps office having jurisdiction over that USACE project.

(c) *Form of Pre-Construction Notification:* The nationwide permit pre-construction notification form (Form ENG 6082) should be used for NWP PCNs. A letter containing the required information may also be used. Applicants may provide electronic files of PCNs and supporting materials if the district engineer has established tools and procedures for electronic submittals.

(d) *Agency Coordination:*

(1) The district engineer will consider any comments from Federal and state agencies concerning the proposed activity's compliance with the terms and conditions of the NWP's and the need for mitigation to reduce the activity's adverse environmental effects so that they are no more than minimal.

(2) Agency coordination is required for:

(i) All NWP activities that require pre-construction notification and result in the loss of greater than 1/2-acre of waters of the United States;

(ii) NWP 13 activities in excess of 500 linear feet, fills greater than one cubic yard per running foot, or involve discharges of dredged or fill material into special aquatic sites; and

(iii) NWP 54 activities in excess of 500 linear feet, or that extend into the waterbody more than 30 feet from the mean low water line in tidal waters or the ordinary high water mark in the Great Lakes.

(3) When agency coordination is required, the district engineer will immediately provide (e.g., via email, facsimile transmission, overnight mail, or other expeditious manner) a copy of the complete PCN to the appropriate Federal or state offices (FWS, state natural resource or water quality agency, EPA, and, if appropriate, the NMFS). With the exception of NWP 37, these agencies will have 10 calendar days from the date the material is transmitted to notify the district engineer via telephone, facsimile transmission, or email that they intend to provide substantive, site-specific comments. The comments must explain why the agency believes the adverse environmental effects will be more than minimal. If so, contacted by an agency, the district engineer will wait an additional 15 calendar days before making a decision on the pre-construction notification. The district engineer will fully consider agency comments received within the specified time frame concerning the proposed activity's compliance with the terms and conditions of the NWP's, including the need for mitigation to ensure that the net adverse environmental effects of the proposed activity are no more than minimal. The district engineer will provide no response to the resource agency, except as provided below. The district engineer will indicate in the administrative record associated with each pre-construction notification that the resource agencies' concerns were considered. For NWP 37, the emergency watershed protection and rehabilitation activity may proceed immediately in cases where there is an unacceptable hazard to life or a significant loss of property or economic hardship will occur. The district engineer will consider any comments received to decide whether the NWP 37 authorization should be modified, suspended, or revoked in accordance with the procedures at 33 CFR 330.5.

(4) In cases of where the prospective permittee is not a Federal agency, the district engineer will provide a response to NMFS within 30 calendar days of receipt of any Essential Fish Habitat conservation recommendations, as required by section 305(b)(4)(B) of the Magnuson-Stevens Fishery Conservation and Management Act.

(5) Applicants are encouraged to provide the Corps with either electronic files or multiple copies of pre-construction notifications to expedite agency coordination.

DISTRICT ENGINEER'S DECISION

1. In reviewing the PCN for the proposed activity, the district engineer will determine whether the activity authorized by the NWP will result in more than minimal individual or cumulative adverse environmental effects or may be contrary to the public interest. If a project proponent requests authorization by a specific NWP, the district engineer should issue the NWP verification for that activity if it meets the terms and conditions of that NWP, unless he or she determines, after considering mitigation, that the proposed activity will result in more than minimal individual and cumulative adverse effects on the aquatic environment and other aspects of the public interest and exercises discretionary authority to require an individual permit for the proposed activity. For a linear project, this determination will include an evaluation of the single and complete crossings of waters of the United States that require PCNs to determine whether they individually satisfy the terms and conditions of the NWP(s), as well as the cumulative effects caused by all of the crossings of waters of the United States authorized by an NWP. If an applicant requests a waiver of an applicable limit, as provided for in NWPs 13, 36, or 54, the district engineer will only grant the waiver upon a written determination that the NWP activity will result in only minimal individual and cumulative adverse environmental effects.

2. When making minimal adverse environmental effects determinations the district engineer will consider the direct and indirect effects caused by the NWP activity. He or she will also consider the cumulative adverse environmental effects caused by activities authorized by an NWP and whether those cumulative adverse environmental effects are no more than minimal. The district engineer will also consider site specific factors, such as the environmental setting in the vicinity of the NWP activity, the type of resource that will be affected by the NWP activity, the functions provided by the aquatic resources that will be affected by the NWP activity, the degree or magnitude to which the aquatic resources perform those functions, the extent that aquatic resource functions will be lost as a result of the NWP activity (e.g., partial or complete loss), the duration of the adverse effects (temporary or permanent), the importance of the aquatic resource functions to the region (e.g., watershed or ecoregion), and mitigation required by the district engineer. If an appropriate functional or condition assessment method is available and practicable to use, that assessment method may be used by the district engineer to assist in the minimal adverse environmental effects determination. The district engineer may add case-specific special conditions to the NWP authorization to address site-specific environmental concerns.

3. If the proposed activity requires a PCN and will result in a loss of greater than 1/10-acre of wetlands or 3/100-acre of stream bed, the prospective permittee should submit a mitigation proposal with the PCN. Applicants may also propose compensatory mitigation for NWP activities with smaller impacts, or for impacts to other types of waters. The district engineer will consider any proposed compensatory mitigation or other mitigation measures the applicant has included in the proposal in determining whether the net adverse environmental effects of the proposed activity are no more than minimal. The compensatory mitigation proposal may be either conceptual or detailed. If the district engineer determines that the activity complies with the terms and conditions of the NWP and that the adverse environmental effects are no more than minimal, after considering mitigation, the district engineer will notify the permittee and include any activity-specific conditions in the NWP verification the district engineer deems necessary. Conditions for compensatory mitigation requirements must comply with the appropriate provisions at 33 CFR 332.3(k). The district engineer must approve the final mitigation plan before the permittee commences work in waters of the United States, unless the district engineer determines that prior approval of the final mitigation plan is not practicable or not necessary to ensure timely completion of the required compensatory mitigation. If the

prospective permittee elects to submit a compensatory mitigation plan with the PCN, the district engineer will expeditiously review the proposed compensatory mitigation plan. The district engineer must review the proposed compensatory mitigation plan within 45 calendar days of receiving a complete PCN and determine whether the proposed mitigation would ensure that the NWP activity results in no more than minimal adverse environmental effects. If the net adverse environmental effects of the NWP activity (after consideration of the mitigation proposal) are determined by the district engineer to be no more than minimal, the district engineer will provide a timely written response to the applicant. The response will state that the NWP activity can proceed under the terms and conditions of the NWP, including any activity-specific conditions added to the NWP authorization by the district engineer.

4. If the district engineer determines that the adverse environmental effects of the proposed activity are more than minimal, then the district engineer will notify the applicant either:

(a) That the activity does not qualify for authorization under the NWP and instruct the applicant on the procedures to seek authorization under an individual permit;

(b) that the activity is authorized under the NWP subject to the applicant's submission of a mitigation plan that would reduce the adverse environmental effects so that they are no more than minimal; or

(c) that the activity is authorized under the NWP with specific modifications or conditions. Where the district engineer determines that mitigation is required to ensure no more than minimal adverse environmental effects, the activity will be authorized within the 45-day PCN period (unless additional time is required to comply with general conditions 18, 20, and/or 31), with activity-specific conditions that state the mitigation requirements. The authorization will include the necessary conceptual or detailed mitigation plan or a requirement that the applicant submit a mitigation plan that would reduce the adverse environmental effects so that they are no more than minimal. When compensatory mitigation is required, no work in waters of the United States may occur until the district engineer has approved a specific mitigation plan or has determined that prior approval of a final mitigation plan is not practicable or not necessary to ensure timely completion of the required compensatory mitigation.

FURTHER INFORMATION

1. District engineers have authority to determine if an activity complies with the terms and conditions of an NWP.
2. NWPs do not obviate the need to obtain other federal, state, or local permits, approvals, or authorizations required by law.
3. NWPs do not grant any property rights or exclusive privileges.
4. NWPs do not authorize any injury to the property or rights of others.
5. NWPs do not authorize interference with any existing or proposed Federal project (see general condition 31).

DEFINITIONS

Best management practices (BMPs): Policies, practices, procedures, or structures implemented to mitigate the adverse environmental effects on surface water quality resulting from development. BMPs are categorized as structural or non-structural.

Compensatory mitigation: The restoration (re-establishment or rehabilitation), establishment (creation), enhancement, and/or in certain circumstances preservation of aquatic resources for

P-23

Nationwide Permit 14 - Activities, Regional Conditions, General Conditions, and Definitions

the purposes of offsetting unavoidable adverse impacts which remain after all appropriate and practicable avoidance and minimization has been achieved.

Currently serviceable: Useable as is or with some maintenance, but not so degraded as to essentially require reconstruction.

Direct effects: Effects that are caused by the activity and occur at the same time and place.

Discharge: The term “discharge” means any discharge of dredged or fill material into waters of the United States.

Ecological reference: A model used to plan and design an aquatic habitat and riparian area restoration, enhancement, or establishment activity under NWP 27. An ecological reference may be based on the structure, functions, and dynamics of an aquatic habitat type or a riparian area type that currently exists in the region where the proposed NWP 27 activity is located. Alternatively, an ecological reference may be based on a conceptual model for the aquatic habitat type or riparian area type to be restored, enhanced, or established as a result of the proposed NWP 27 activity. An ecological reference takes into account the range of variation of the aquatic habitat type or riparian area type in the region.

Enhancement: The manipulation of the physical, chemical, or biological characteristics of an aquatic resource to heighten, intensify, or improve a specific aquatic resource function(s). Enhancement results in the gain of selected aquatic resource function(s), but may also lead to a decline in other aquatic resource function(s). Enhancement does not result in a gain in aquatic resource area.

Establishment (creation): The manipulation of the physical, chemical, or biological characteristics present to develop an aquatic resource that did not previously exist at an upland site. Establishment results in a gain in aquatic resource area.

High Tide Line: The line of intersection of the land with the water’s surface at the maximum height reached by a rising tide. The high tide line may be determined, in the absence of actual data, by a line of oil or scum along shore objects, a more or less continuous deposit of fine shell or debris on the foreshore or berm, other physical markings or characteristics, vegetation lines, tidal gages, or other suitable means that delineate the general height reached by a rising tide. The line encompasses spring high tides and other high tides that occur with periodic frequency but does not include storm surges in which there is a departure from the normal or predicted reach of the tide due to the piling up of water against a coast by strong winds such as those accompanying a hurricane or other intense storm.

Historic Property: Any prehistoric or historic district, site (including archaeological site), building, structure, or other object included in, or eligible for inclusion in, the National Register of Historic Places maintained by the Secretary of the Interior. This term includes artifacts, records, and remains that are related to and located within such properties. The term includes properties of traditional religious and cultural importance to an Indian tribe or Native Hawaiian organization and that meet the National Register criteria (36 CFR part 60).

Independent utility: A test to determine what constitutes a single and complete non-linear project in the Corps Regulatory Program. A project is considered to have independent utility if it would be constructed absent the construction of other projects in the project area. Portions of a multi-phase project that depend upon other phases of the project do not have independent

utility. Phases of a project that would be constructed even if the other phases were not built can be considered as separate single and complete projects with independent utility.

Indirect effects: Effects that are caused by the activity and are later in time or farther removed in distance but are still reasonably foreseeable.

Loss of waters of the United States: Waters of the United States that are permanently adversely affected by filling, flooding, excavation, or drainage because of the regulated activity. The loss of stream bed includes the acres of stream bed that are permanently adversely affected by filling or excavation because of the regulated activity. Permanent adverse effects include permanent discharges of dredged or fill material that change an aquatic area to dry land, increase the bottom elevation of a waterbody, or change the use of a waterbody. The acreage of loss of waters of the United States is a threshold measurement of the impact to jurisdictional waters or wetlands for determining whether a project may qualify for an NWP; it is not a net threshold that is calculated after considering compensatory mitigation that may be used to offset losses of aquatic functions and services. Waters of the United States temporarily filled, flooded, excavated, or drained, but restored to pre-construction contours and elevations after construction, are not included in the measurement of loss of waters of the United States. Impacts resulting from activities that do not require Department of the Army authorization, such as activities eligible for exemptions under section 404(f) of the Clean Water Act, are not considered when calculating the loss of waters of the United States.

Navigable waters: Waters subject to section 10 of the Rivers and Harbors Act of 1899. These waters are defined at 33 CFR part 329.

Non-tidal wetland: A non-tidal wetland is a wetland that is not subject to the ebb and flow of tidal waters. Non-tidal wetlands contiguous to tidal waters are located landward of the high tide line (i.e., spring high tide line).

Open water: For purposes of the NWPs, an open water is any area that in a year with normal patterns of precipitation has water flowing or standing above ground to the extent that an ordinary high water mark can be determined. Aquatic vegetation within the area of flowing or standing water is either non-emergent, sparse, or absent. Vegetated shallows are considered to be open waters. Examples of “open waters” include rivers, streams, lakes, and ponds.

Ordinary High Water Mark: The term ordinary high water mark means that line on the shore established by the fluctuations of water and indicated by physical characteristics such as a clear, natural line impressed on the bank, shelving, changes in the character of soil, destruction of terrestrial vegetation, the presence of litter and debris, or other appropriate means that consider the characteristics of the surrounding areas.

Perennial stream: A perennial stream has surface water flowing continuously year-round during a typical year.

Practicable: Available and capable of being done after taking into consideration cost, existing technology, and logistics in light of overall project purposes.

Pre-construction notification: A request submitted by the project proponent to the Corps for confirmation that a particular activity is authorized by nationwide permit. The request may be a permit application, letter, or similar document that includes information about the proposed work and its anticipated environmental effects. Pre-construction notification may be required by the terms and conditions of a nationwide permit, or by regional conditions. A pre-

construction notification may be voluntarily submitted in cases where pre-construction notification is not required and the project proponent wants confirmation that the activity is authorized by nationwide permit.

Preservation: The removal of a threat to, or preventing the decline of, aquatic resources by an action in or near those aquatic resources. This term includes activities commonly associated with the protection and maintenance of aquatic resources through the implementation of appropriate legal and physical mechanisms. Preservation does not result in a gain of aquatic resource area or functions.

Re-establishment: The manipulation of the physical, chemical, or biological characteristics of a site with the goal of returning natural/historic functions to a former aquatic resource. Re-establishment results in rebuilding a former aquatic resource and results in a gain in aquatic resource area and functions.

Rehabilitation: The manipulation of the physical, chemical, or biological characteristics of a site with the goal of repairing natural/historic functions to a degraded aquatic resource. Rehabilitation results in a gain in aquatic resource function but does not result in a gain in aquatic resource area.

Restoration: The manipulation of the physical, chemical, or biological characteristics of a site with the goal of returning natural/historic functions to a former or degraded aquatic resource. For the purpose of tracking net gains in aquatic resource area, restoration is divided into two categories: Re-establishment and rehabilitation.

Riffle and pool complex: Riffle and pool complexes are special aquatic sites under the 404(b)(1) Guidelines. Riffle and pool complexes sometimes characterize steep gradient sections of streams. Such stream sections are recognizable by their hydraulic characteristics. The rapid movement of water over a coarse substrate in riffles results in a rough flow, a turbulent surface, and high dissolved oxygen levels in the water. Pools are deeper areas associated with riffles. A slower stream velocity, a streaming flow, a smooth surface, and a finer substrate characterize pools.

Riparian areas: Riparian areas are lands next to streams, lakes, and estuarine-marine shorelines. Riparian areas are transitional between terrestrial and aquatic ecosystems, through which surface and subsurface hydrology connects riverine, lacustrine, estuarine, and marine waters with their adjacent wetlands, non-wetland waters, or uplands. Riparian areas provide a variety of ecological functions and services and help improve or maintain local water quality. (See general condition 23.)

Shellfish seeding: The placement of shellfish seed and/or suitable substrate to increase shellfish production. Shellfish seed consists of immature individual shellfish or individual shellfish attached to shells or shell fragments (i.e., spat on shell). Suitable substrate may consist of shellfish shells, shell fragments, or other appropriate materials placed into waters for shellfish habitat.

Single and complete linear project: A linear project is a project constructed for the purpose of getting people, goods, or services from a point of origin to a terminal point, which often involves multiple crossings of one or more waterbodies at separate and distant locations. The term "single and complete project" is defined as that portion of the total linear project proposed or accomplished by one owner/developer or partnership or other association of owners/developers that includes all crossings of a single water of the United States (i.e., a

single waterbody) at a specific location. For linear projects crossing a single or multiple waterbodies several times at separate and distant locations, each crossing is considered a single and complete project for purposes of NWP authorization. However, individual channels in a braided stream or river, or individual arms of a large, irregularly shaped wetland or lake, etc., are not separate waterbodies, and crossings of such features cannot be considered separately.

Single and complete non-linear project: For non-linear projects, the term “single and complete project” is defined at 33 CFR 330.2(i) as the total project proposed or accomplished by one owner/developer or partnership or other association of owners/developers. A single and complete non-linear project must have independent utility (see definition of “independent utility”). Single and complete non-linear projects may not be “piecemealed” to avoid the limits in an NWP authorization.

Stormwater management: Stormwater management is the mechanism for controlling stormwater runoff for the purposes of reducing downstream erosion, water quality degradation, and flooding and mitigating the adverse effects of changes in land use on the aquatic environment.

Stormwater management facilities: Stormwater management facilities are those facilities, including but not limited to, stormwater retention and detention ponds and best management practices, which retain water for a period of time to control runoff and/or improve the quality (i.e., by reducing the concentration of nutrients, sediments, hazardous substances and other pollutants) of stormwater runoff.

Stream bed: The substrate of the stream channel between the ordinary high water marks. The substrate may be bedrock or inorganic particles that range in size from clay to boulders. Wetlands contiguous to the stream bed, but outside of the ordinary high water marks, are not considered part of the stream bed.

Stream channelization: The manipulation of a stream’s course, condition, capacity, or location that causes more than minimal interruption of normal stream processes. A channelized jurisdictional stream remains a water of the United States.

Structure: An object that is arranged in a definite pattern of organization. Examples of structures include, without limitation, any pier, boat dock, boat ramp, wharf, dolphin, weir, boom, breakwater, bulkhead, revetment, riprap, jetty, artificial island, artificial reef, permanent mooring structure, power transmission line, permanently moored floating vessel, piling, aid to navigation, or any other manmade obstacle or obstruction.

Tidal wetland: A tidal wetland is a jurisdictional wetland that is inundated by tidal waters. Tidal waters rise and fall in a predictable and measurable rhythm or cycle due to the gravitational pulls of the moon and sun. Tidal waters end where the rise and fall of the water surface can no longer be practically measured in a predictable rhythm due to masking by other waters, wind, or other effects. Tidal wetlands are located channelward of the high tide line.

Tribal lands: Any lands title to which is either: (1) Held in trust by the United States for the benefit of any Indian tribe or individual; or (2) held by any Indian tribe or individual subject to restrictions by the United States against alienation.

Tribal rights: Those rights legally accruing to a tribe or tribes by virtue of inherent sovereign

P-27

Nationwide Permit 14 - Activities, Regional Conditions, General Conditions, and Definitions

authority, unextinguished aboriginal title, treaty, statute, judicial decisions, executive order or agreement, and that give rise to legally enforceable remedies.

Vegetated shallows: Vegetated shallows are special aquatic sites under the 404(b)(1) Guidelines. They are areas that are permanently inundated and under normal circumstances have rooted aquatic vegetation, such as seagrasses in marine and estuarine systems and a variety of vascular rooted plants in freshwater systems.

Waterbody: For purposes of the NWP, a waterbody is a “water of the United States.” If a wetland is adjacent to a waterbody determined to be a water of the United States, that waterbody and any adjacent wetlands are considered together as a single aquatic unit (see 33 CFR 328.4(c)(2)).

REGIONAL CONDITIONS:

The following Regional Conditions have been approved by the Wilmington District for the Nationwide Permits (NWP) published in the January 13, 2021, and December 27, 2021, *Federal Register* (86 FR 2744 and 86 FR 73522) announcing the reissuance of 52 existing (NWP) and five new NWP, as well as the reissuance of NWP general conditions and definitions with some modifications.

A. EXCLUDED WATER AND/OR AREAS

The Corps has identified waters that will be excluded from the use of all NWP's during certain timeframes. These waters are:

1. **Anadromous Fish Spawning Areas.** Work in waters of the U.S. designated by either the North Carolina Division of Marine Fisheries (NCDMF) or the North Carolina Wildlife Resources Commission (NCWRC) as anadromous fish spawning areas are prohibited from February 15th through June 30th, without prior written approval from the Corps and the appropriate wildlife agencies (NCDMF, NCWRC and/or the National Marine Fisheries Service (NMFS)). Work in waters of the U.S. designated by NCWRC as primary nursery areas in inland waters are prohibited from February 15th through September 30th, without prior written approval from the Corps and the appropriate wildlife agencies. Work in waters of the U.S. designated by NCDMF as primary nursery areas shall be coordinated with NCDMF prior to being authorized by this NWP. Coordination with NCDMF may result in a required construction moratorium during periods of significant biological productivity or critical life stages.
2. **Trout Waters Moratorium.** Work in waters of the U.S. in the designated trout watersheds of North Carolina are prohibited from October 15th through April 15th without prior written approval from the NCWRC, or from the Eastern Band of Cherokee Indians (EBCI) Fisheries and Wildlife Management (FWM) office if the project is located on EBCI trust land. (See Section C.3. below for information on the designated trout watersheds).
3. **Sturgeon Spawning Areas.** No in-water work shall be conducted in waters of the U.S. designated by the National Marine Fisheries Service as Atlantic sturgeon critical habitat from February 1st through June 30th. No in-water work shall be conducted in waters of the U.S. in the Roanoke River designated as Atlantic sturgeon critical habitat from February 1st through June 30th, and August 1st through October 31st, without prior written approval from NMFS.
4. **Submerged Aquatic Vegetation.** Impacts to Submerged Aquatic Vegetation (SAV) are not authorized by any NWP, except NWP 48, NWP 55 and NWP 56, unless Essential Fish Habitat (EFH) consultation has been completed pursuant to the Magnuson-Stevens Fisheries Conservation and Management Act (Magnuson-Stevens Act). Permittees shall submit a PCN (See NWP General Condition 32) to the District Engineer prior to commencing the activity if the project would affect SAV. The permittee may not begin work until notified by the Corps that the requirements of the Magnuson-Stevens Act have been satisfied and that the activity is verified.

B. REGIONAL CONDITIONS APPLICABLE TO ALL NWP's

1. **Critical Habitat in Western NC.** For proposed activities within waters of the U.S. that require a Pre-Construction Notification (PCN) and are located in the thirteen counties listed below, permittees must provide a copy of the PCN to the U.S. Fish and Wildlife Service (USFWS), 160 Zillicoa Street, Asheville, North Carolina 28801 and the Corps Asheville Regulatory Field Office. Please see General Condition 18 for specific PCN requirements

P-29

Nationwide Permit 14 - Activities, Regional Conditions, General Conditions, and Definitions

related to the Endangered Species Act and the below website for information on the location of designated critical habitat.

Counties with tributaries that drain to designated critical habitat that require notification to the Asheville U.S. Fish and Wildlife Service: Avery, Cherokee, Graham, Haywood, Henderson, Jackson, Macon, Mecklenburg, Mitchell, Swain, Transylvania, Union and Yancey.

Website and office addresses for Endangered Species Act Information:

The Wilmington District has developed the following website for permittees which provides guidelines on how to review linked websites and maps in order to fulfill NWP General Condition 18 (Endangered Species) requirements:

<http://www.saw.usace.army.mil/Missions/RegulatoryPermitProgram/AgencyCoordination/ESA.aspx>.

Permittees who do not have internet access may contact the appropriate U.S. Fish and Wildlife Service offices listed below or Corps at (910) 251-4850.

Below is a map of the USFWS Field Office Boundaries:

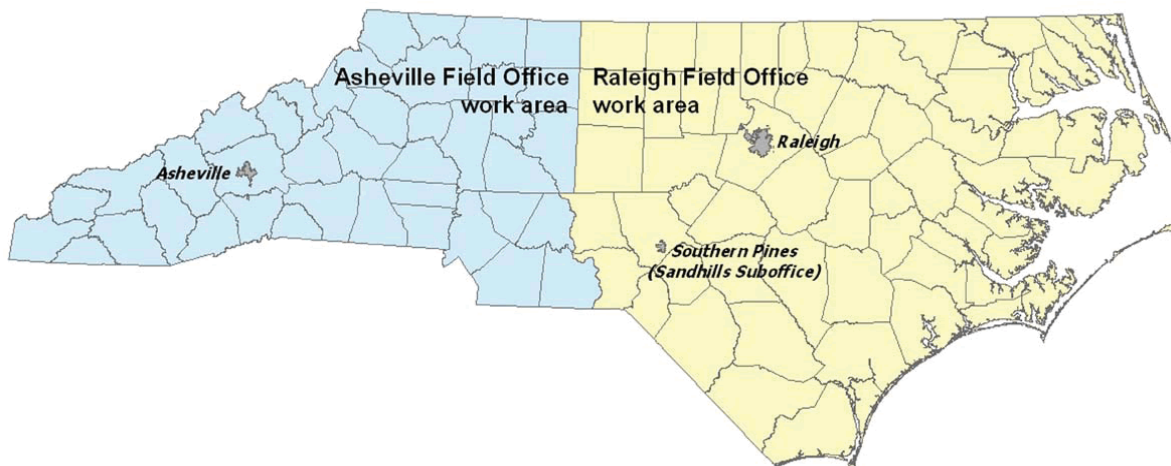

Asheville U.S. Fish and Wildlife Service Office counties: All counties west of and including Anson, Stanly, Davidson, Forsythe and Stokes Counties.

U.S. Fish and Wildlife Service
Asheville Field Office
160 Zillicoa Street
Asheville, NC 28801
Telephone: (828) 258-3939

Raleigh U.S. Fish and Wildlife Service Office counties: All counties east of and including Richmond, Montgomery, Randolph, Guilford, and Rockingham Counties.

U.S. Fish and Wildlife Service
Raleigh Field Office
Post Office Box 33726
Raleigh, NC 27636-3726
Telephone: (919) 856-4520

P-30

2. **Special Designation Waters.** Prior to the use of any NWP that involves a discharge of dredged or fill material in any of the following identified waters and/or adjacent wetlands in North Carolina, permittees shall submit a PCN to the District Engineer prior to commencing the activity (see General Condition 32). The North Carolina waters and wetlands that require additional PCN requirements are:

“Primary Nursery Areas” (PNA), including inland PNA, as designated by the North Carolina Marine Fisheries Commission and/or the North Carolina Wildlife Resources Commission. The definition of and designated PNA waters can be found in the North Carolina State Administrative Code at Title 15A, Subchapters 3R and 10C (15A NCAC 03R .0103; 15A NCAC 10C .0502; and 15A NCAC 10C .0503) and at the following web pages:

- <http://reports.oah.state.nc.us/ncac/title%2015a%20-%20environmental%20quality/chapter%2003%20-%20marine%20fisheries/subchapter%20r/15a%20ncac%2003r%20.0103.pdf>
- <http://reports.oah.state.nc.us/ncac/title%2015a%20-%20environmental%20quality/chapter%2010%20-%20wildlife%20resources%20and%20water%20safety/subchapter%20c/15a%20ncac%2010c%20.0502.pdf>
- <http://reports.oah.state.nc.us/ncac/title%2015a%20-%20environmental%20quality/chapter%2010%20-%20wildlife%20resources%20and%20water%20safety/subchapter%20c/15a%20ncac%2010c%20.0503.pdf>

3. **Trout Waters.** Prior to any discharge of dredge or fill material into streams, waterbodies or wetlands within the 294 designated trout watersheds of North Carolina, the permittee shall submit a PCN (see General Condition 32) to the District Engineer prior to commencing the activity. The permittee shall also provide a copy of the PCN to the appropriate NCWRC office, or to the EBCI FWM Office (if the project is located on EBCI trust land), to facilitate the determination of any potential impacts to designated Trout Waters.

NCWRC and NC Trout Watersheds:

NCWRC Contact**	Counties that are entirely within Trout Watersheds*	Counties that are partially within Trout Watersheds*
------------------------	------------------------------------------------------------	-------------------------------------------------------------

P-31

Nationwide Permit 14 - Activities, Regional Conditions, General Conditions, and Definitions

Mountain Coordinator 645 Fish Hatchery Rd., Building B Marion, NC 28752 828-803- 6054 For NCDOT Projects: NCDOT Coordinator 12275 Swift Rd. Oakboro, NC 28129 704-984- 1070	Alleghany Ashe Avery Graham Haywood	Jackson Macon Swain Transylvania Watauga	Burke Buncombe Caldwell Cherokee Clay Henderson Madison	McDowell Mitchell Polk Rutherford Surry Wilkes Yancey
EBCI Contact**	Counties that are within Trout Watersheds*			
Office of Natural Resources P.O. Box 1747, Cherokee, NC 28719 (828) 359-6113	Qualla Boundary and non- contiguous tracts of trust land located in portions of Swain, Jackson, Haywood, Graham and Cherokee Counties.			

*NOTE: To determine PCN requirements, contact the Corps Asheville Regulatory Field Office at (828) 271-7980 or view maps showing trout watersheds in each County at the following webpage: <http://www.saw.usace.army.mil/Missions/Regulatory-Permit-Program/Agency-Coordination/Trout/>.

**If a project is located on EBCI trust land, submit the PCN in accordance with Regional Condition C.16. Contact the Corps Asheville Regulatory Field Office at (828) 271-7980 with questions.

4. **Western NC Waters and Corridors.** The permittee shall submit a PCN (see General Condition 32) to the District Engineer prior to commencing the activity in waters of the U.S. if the activity will occur within any of the following identified waters in western North Carolina, within 0.5 mile on either side of these waters, or within 0.75 mile of the Little Tennessee River, as measured from the top of the bank of the respective water (i.e., river, stream, or creek):

Brasstown Creek
Burningtown Creek

Cane River
Caney Fork
Cartoogechaye Creek
Chattooga River
Cheoah River
Cowee Creek
Cullasaja River
Deep Creek
Ellijay Creek
French Broad River
Garden Creek
Hiwassee River
Hominy Creek
Iotla Creek
Little Tennessee River (within the river or within 0.75 mile on either side of this river)
Nantahala River
Nolichucky River
North Fork French Broad River
North Toe River
Nottley River
Oconaluftee River (portion not located on trust/EBCI land)
Peachtree Creek
Shooting Creek
Snowbird Creek
South Toe River
Stecoah Creek
Swannanoa River
Sweetwater Creek
Tuckasegee River (also spelled Tuckaseegee or Tuckaseigee)
Valley River
Watauga Creek
Watauga River
Wayah Creek
West Fork French Broad River

To determine PCN requirements, contact the Corps Asheville Regulatory Field Office at (828) 271-7980 or view maps for all corridors at the following webpage:

<http://www.saw.usace.army.mil/Missions/Regulatory-Permit-Program/Agency-Coordination/Designated-Special-Waters.aspx>.

5. **Limitation of Loss of Stream Bed.** NWP's may not be used for activities that may result in the loss of more than 0.05 acres of stream bed, except for NWP 32.

6. **Pre-Construction Notification for Loss of Stream Bed Exceeding 0.02 acres.** The permittee shall submit a PCN to the District Engineer prior to commencing the activity (see General Condition 32) prior to the use of any NWP for any activity that results in the loss of more than 0.02 acres of stream bed. This applies to NWP's that do not have PCN requirements as well as those NWP's that require a PCN.

7. **Mitigation for Loss of Stream Bed.** For any NWP that results in a loss of more than 0.02 acres of stream bed, the permittee shall provide a mitigation proposal to compensate for more than minimal individual and cumulative adverse impacts to the aquatic environment, unless the

District Engineer determines in writing that either some other form of mitigation would be more environmentally appropriate or the adverse effects of the proposed activity are minimal. For stream bed losses of 0.02 acres or less that require a PCN, the District Engineer may determine, on a case-by-case basis, that compensatory mitigation is required to ensure that the activity results in minimal adverse effect on the aquatic environment.

8. **Riprap.** For all NWP's that allow for the use of riprap material for bank stabilization, the following conditions shall be applied:

a. Filter cloth must be placed underneath the riprap as an additional requirement of its use in North Carolina waters. The placement of filter fabric is not required if the riprap will be pushed or "keyed" into the bank of the waterbody. A waiver from the specifications in this Regional Condition must be requested in writing.

b. Riprap shall be placed only on the stream banks, or, if it is necessary to be placed in the stream bed, the finished top elevation of the riprap should not exceed that of the original stream bed.

9. **Culvert Placement.** For all NWP's that allow for culvert placement, the following conditions shall be applied:

a. For all NWP's that involve the construction/installation of culverts, measures shall be included in the construction/installation that will promote the safe passage of fish and other aquatic organisms

Placement of culverts and other structures in streams shall be below the elevation of the streambed by one foot for all culverts with a diameter greater than 48 inches, and 20% of the culvert diameter for culverts having a diameter less than or equal to 48 inches. If the culvert outlet is submerged within a pool or scour hole and designed to provide for aquatic passage, then culvert burial into the streambed is not required.

Culvert burial is not required for structures less than 72 inch diameter/width, where the slope of the culvert will be greater than 2.5%, provided that all alternative options for flattening the slope have been investigated and aquatic life movement/connectivity has been provided when possible (e.g., rock ladders, cross vanes, sills, baffles etc.). Culvert burial is not required when bedrock is present in culvert locations.

Installation of culverts in wetlands shall ensure continuity of water movement and be designed to adequately accommodate high water or flood conditions. When roadways, causeways, or other fill projects are constructed across FEMA-designated floodways or wetlands, openings such as culverts or bridges shall be provided to maintain the natural hydrology of the system as well as prevent constriction of the floodway that may result in destabilization of streams or wetlands.

P-34

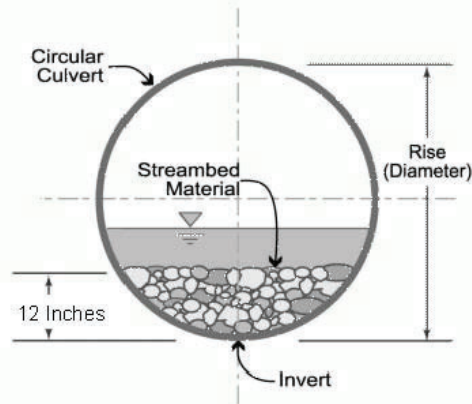

A waiver from the depth specifications in this condition may be requested, in writing, by the permittee and issued by the Corp. This waiver request must be specific as to the reason(s) for the request. The waiver will be issued if it can be demonstrated that the proposed design would result in less impacts to the aquatic environment. Culverts placed across wetland fills purely for the purposes of equalizing surface water do not have to be buried, but the culverts must be of adequate size and/or number to ensure unrestricted transmission of water.

b. Bank-full flows (or less) shall be accommodated through maintenance of the existing bank-full channel cross sectional area. Additional culverts or culvert barrels at such crossings shall be allowed only to receive bank-full flows.

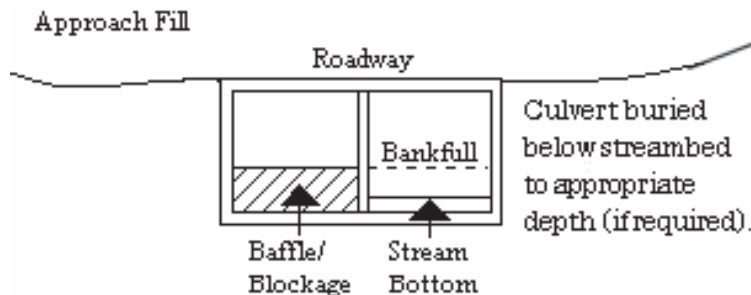

c. Culverts shall be designed and installed in such a manner that the original stream profiles are not altered and allow for aquatic life movement during low flows. The dimension, pattern, and profile of the stream above and below a pipe or culvert shall not be modified by widening the stream channel or by reducing the depth of the stream in connection with the construction activity. The width, height, and gradient of a proposed culvert shall be such as to pass the average historical low flow and spring flow without adversely altering flow velocity. If the width of the culvert is wider than the stream channel, the culvert shall include multiple boxes/pipes, baffles, benches and/or sills to maintain the natural width of the stream channel. If multiple culverts/pipes/barrels are used, low flows shall be accommodated in one culvert/pipe and additional culverts/pipes shall be installed such that they receive only flows above bankfull.

10. **Utility Lines.** For all NWP that allow for the construction and installation of utility lines, the following conditions shall be applied:

a. Utility lines consisting of aerial electric power transmission lines crossing navigable waters of the U.S. (which are defined at 33 CFR part 329) must comply with the applicable minimum clearances specified in 33 CFR 322.5(i).

b. The work area authorized by this permit, including temporary and/or permanent fills, will be minimized to the greatest extent practicable. Justification for work corridors exceeding forty (40) feet in width is required and will be based on pipeline diameter and length, size of equipment required to construct the utility line, and other construction information deemed necessary to support the request. The permittee is required to provide this information to the Corps with the initial PCN package.

c. A plan to restore and re-vegetate wetland areas cleared for construction must be submitted with the required PCN. Cleared wetland areas shall be re-vegetated, as appropriate, with species of canopy, shrub, and herbaceous species. The permittee shall not use fescue grass or any other species identified as invasive or exotic species by the NC Native Plant Society (NCNPS): <https://ncwildflower.org/invasive-exotic-species-list/>.

d. Any permanently maintained corridor along the utility right of way within forested wetlands shall be considered a loss of aquatic function. A compensatory mitigation plan will be required for all such impacts associated with the requested activity if the activity requires a PCN and the cumulative total of permanent conversion of forested wetlands exceeds 0.1 acres, unless the District Engineer determines in writing that either some other form of mitigation would be more environmentally appropriate or the adverse effects of the proposed activity are minimal.

Where permanently maintained corridor within forested wetlands is 0.1 acres or less, the District Engineer may determine, on a case-by-case basis, that compensatory mitigation is required to ensure that the activity results in minimal adverse effects on the aquatic environment.

e. When directional boring or horizontal directional drilling (HDD) under waters of the U.S., including wetlands, permittees shall closely monitor the project for hydraulic fracturing or “fracking.” Any discharge from hydraulic fracturing or “fracking” into waters of the U.S., including wetlands, shall be reported to the appropriate Corps Regulatory Field Office within 48 hours. Restoration and/or compensatory mitigation may be required as a result of any unintended discharges.

11. **Temporary Access Fills.** The permittee shall submit a PCN to the District Engineer prior to commencing the activity if the activity will involve the discharge of dredged or fill material into more than 0.1 acres of wetlands or 0.02 acres of stream channel for the construction of temporary access fills and/or temporary road crossings. The PCN must include a restoration plan that thoroughly describes how all temporary fills will be removed, how pre-project conditions will be restored, and include a timetable for all restoration activities.

12. **Federal Navigation Channel Setbacks.** Authorized structures and fills located in or adjacent to Federally authorized waterways must be constructed in accordance with the latest setback criteria established by the Wilmington District Engineer. You may review the setback policy at <http://www.saw.usace.army.mil/Missions/Navigation/Setbacks.aspx>. This general permit does not authorize the construction of hardened or permanently fixed structures within the Federally Authorized Channel Setback, unless the activity is approved by the Corps. The permittee shall submit a PCN (see General Condition 32) to the District Engineer to obtain a written verification prior to the construction of any structures or fills within the Federally Authorized Channel Setback.

13. **Northern Long-eared Bat – Endangered Species Act Compliance.** The Wilmington District, U.S. Army Corps of Engineers has consulted with the United States Fish and Wildlife

P-36

Nationwide Permit 14 - Activities, Regional Conditions, General Conditions, and Definitions

Service (USFWS) in regard to the threatened northern long-eared bat (NLEB) (*Myotis septentrionalis*) and Standard Local Operating Procedures for Endangered Species (SLOPES) have been approved by the Corps and the USFWS. This condition concerns effects to the NLEB only and does not address effects to other federally listed species and/or federally designated critical habitat.

a. Procedures when the Corps is the lead federal* agency for a project:

The permittee must comply with (1) and (2) below when:

- the project is located in the western 41 counties of North Carolina, to include non-federal aid North Carolina Department of Transportation (NCDOT) projects, OR;
- the project is located in the 59 eastern counties of North Carolina and is a non-NCDOT project.

*Generally, if a project is located on private property or on non-federal land, and the project is not being funded by a federal entity, the Corps will be the lead federal agency due to the requirement to obtain Department of the Army authorization to impact waters of the U.S. If the project is located on federal land, contact the Corps to determine the lead federal agency.

(1) A permittee using an NWP must check to see if their project is located in the range of the NLEB by using the following website:

<http://www.fws.gov/midwest/endangered/mammals/nleb/pdf/WNSZone.pdf>. If the project is within the range of the NLEB, or if the project includes percussive activities (e.g., blasting, pile driving, etc.), the permittee is then required to check the appropriate website in the paragraph below to discover if their project:

- is located in a 12-digit Hydrologic Unit Code area ("red HUC" - shown as red areas on the map), AND/OR;
- involves percussive activities within 0.25 mile of a red HUC.

Red HUC maps - for the western 41 counties in NC (covered by the Asheville Ecological Services Field Office), check the project location against the electronic maps found at: http://www.fws.gov/asheville/htmls/project_review/NLEB_in_WNC.html. For the eastern 59 counties in NC (covered by the Raleigh Ecological Services Field Office), check the project location against the electronic maps found at: https://www.fws.gov/raleigh/NLEB_RFO.html.

(2) A permittee must submit a PCN to the District Engineer, and receive written verification from the District Engineer, prior to commencing the activity, if the activity will involve any of the following:

- tree clearing/removal and/or, construction/installation of wind turbines in a red HUC, AND/OR;
- bridge removal or maintenance, unless the bridge has been inspected and there is no evidence of bat use, (applies anywhere in the range of the NLEB), AND/OR;
- percussive activities in a red HUC, or within 0.25 mile of a red HUC.

The permittee may proceed with the activity without submitting a PCN to either the Corps or the USFWS, provided the activity complies with all applicable NWP terms and general and regional conditions, if the permittee's review under A.(1) and A.(2) above shows that the project is:

- located outside of a red HUC (and there are no percussive activities), and the activity will NOT include bridge removal or maintenance, unless the bridge has been inspected and there is no evidence of bat use, OR;
- located outside of a red HUC and there are percussive activities, but the percussive activities will not occur within 0.25-mile of a red HUC boundary, and the activity will NOT include bridge removal or maintenance, unless the bridge has been inspected and there is no evidence of bat use, OR;
- located in a red HUC, but the activity will NOT include tree clearing/removal; construction/installation of wind turbines; bridge removal or maintenance, unless the bridge has been inspected and there is no evidence of bat use, and/or; any percussive activities.

b. Procedures when the USACE is not the lead federal agency:

For projects where another federal agency is the lead federal agency - if that other federal agency has completed project-specific ESA Section 7(a)(2) consultation for the NLEB, and has (1) determined that the project would not cause prohibited incidental take of the NLEB, and (2) completed coordination/consultation that is required by the USFWS (per the directions on the respective USFWS office's website), that project may proceed without PCN to either the USACE or the USFWS, provided all General and Regional Permit Conditions are met.

The NLEB SLOPES can be viewed on the USACE website at:

<http://www.saw.usace.army.mil/Missions/Regulatory-Permit-Program/Agency-Coordination/ESA/>. Permittees who do not have internet access may contact the USACE at (910) 251- 4633.

14. **West Indian Manatee Protection.** In order to protect the endangered West Indian manatee (*Trichechus manatus*) the Permittee shall implement the USFWS' Manatee Guidelines, and strictly adhere to all requirements therein. The guidelines can be found at <https://www.fws.gov/raleigh/pdfs/ManateeGuidelines2017.pdf>.

15. **ESA Programmatic Biological Opinions.** The Wilmington District, USFWS, NCDOT, and the FHWA have conducted programmatic Section 7(a)(2) consultation for a number of federally listed species and designated critical habitat (DCH), and programmatic consultation concerning other federally listed species and/or DCH may occur in the future. The result of completed programmatic consultation is a Programmatic Biological Opinion (PBO) issued by the USFWS. These PBOs contain mandatory terms and conditions to implement the reasonable and prudent measures that are associated with "incidental take" of whichever species or critical habitat is covered by a specific PBO. Authorization under NWPs is conditional upon the permittee's compliance with all the mandatory terms and conditions associated with incidental take of the applicable PBO (or PBOs), which are incorporated by reference in the NWPs. Failure to comply with the terms and conditions associated with incidental take of an applicable PBO, where a take of the federally listed species occurs, would constitute an unauthorized take by the permittee, and would also constitute permittee non-compliance with the authorization under the NWPs. If the terms and conditions of a specific PBO (or PBOs) apply to a project, the Corps will include this/these requirements in any NWP verification that may be issued for a project. For an activity/project that does not require a PCN, the terms and conditions of the applicable PBO(s) also apply to that non-notifying

activity/project. The USFWS is the appropriate authority to determine compliance with the terms and conditions of its PBO and the ESA. All PBOs can be found on our website at: <https://www.saw.usace.army.mil/Missions/Regulatory-Permit-Program/Agency-Coordination/ESA/>.

16. Work on Eastern Band of Cherokee Indian Land.

Notifying NWPs - All PCNs submitted for activities in waters of the U.S. on Eastern Band of Cherokee Indians (EBCI) trust land (i.e., Qualla Boundary and non-contiguous tracts of trust land located in portions of Swain, Jackson, Haywood, Graham and Cherokee Counties), must comply with the requirements of the latest MOU between the Wilmington District and the EBCI.

Non-notifying NWPs - Prior to the use of any non-notifying NWP for activities in waters of the U.S. on EBCI trust land (i.e., Qualla Boundary and non-contiguous tracts of trust land located in portions of Swain, Jackson, Haywood, Graham and Cherokee Counties), all prospective permittees must comply with the requirements of the latest MOU between the Wilmington District and the EBCI; this includes coordinating the proposed project with the EBCI Natural Resources Program and obtaining a Tribal Approval Letter from the Tribe.

The EBCI MOU can be found at the following URL: <http://saw-reg.usace.army.mil/FO/Final-MOU-EBCI-USACE.pdf>

17. Sedimentation and Erosion Control Structures and Measures.

All PCNs will identify and describe sedimentation and erosion control structures and measures proposed for placement in waters of the U.S. The structures and measures should be depicted on maps, surveys or drawings showing location and impacts to jurisdictional wetlands and streams.

C. REGIONAL CONDITIONS APPLICABLE TO NWP 14

a. If appropriate, permittees shall employ natural channel design (see definition below and NOTE below) to the maximum extent practicable for stream relocations. All stream relocation proposals shall include a Relocation and Monitoring Plan and a functional assessment of baseline conditions (e.g., use of the North Carolina Stream Assessment Methodology). Compensatory mitigation may be required for stream relocations.

Natural Channel Design means a geomorphologic approach to stream restoration based on an understanding of valley type, general watershed conditions, dimension, pattern, profile, hydrology and sediment transport of natural, stable channels (reference condition) and applying this understanding to the reconstruction of a stable channel.

NOTE: For more information on Natural Channel Design, permittees should reference North Carolina Stream Mitigation Guidance on the Corps RIBITS (Regulatory In-lieu Fee and Bank Information Tracking System) website or at the following World Wide Web Page: <https://ribits.ops.usace.army.mil/ords/f?p=107:2>

b. In designated trout watersheds, a PCN is not required for impacts to a maximum of 0.007 acres (0.02 acres for temporary dewatering). In designated trout waters, the permittee shall submit a PCN (see Regional Conditions C.3. above and General Condition 32) to the District Engineer prior to commencing the activity if 1) impacts (other than temporary dewatering to work in dry conditions) to jurisdictional aquatic resources exceed 0.007 acres; 2) temporary

impacts to streams or waterbodies associated with dewatering to work in dry conditions exceed 0.02 acres; 3) the project will involve impacts to wetlands; 4) the primary purpose of the project is for commercial development; 5) the project involves the replacement of a bridge or spanning structure with a culvert or non-spanning structure in waters of the United States; or 6) the activity will be constructed during the trout waters moratorium (October 15 through April 15).

D. SECTION 401 WATER QUALITY CERTIFICATION (WQC) AND/OR COASTAL ZONE MANAGEMENT ACT (CZMA) CONSISTENCY DETERMINATION SUMMARY AND APPLICABLE CONDITIONS

The CZMA Consistency Determination and all Water Quality Certifications for the NWP's can be found at: <https://www.saw.usace.army.mil/Missions/Regulatory-Permit-Program/Permits/2017-Nationwide-Permits/>

ROY COOPER
Governor

ELIZABETH S. BISER
Secretary

RICHARD E. ROGERS, JR.
Director



NORTH CAROLINA
Environmental Quality

June 13, 2024
Mecklenburg County
NCDWR Project No. 20240584
McKee Road Extension
STIP# U-4713A WBS# 39077.1.2

Mr. Joel Howard
NCDOT, Division 10, PDEA Engineer
716 West Main Street
Albemarle, NC 28001
JMHoward@NCDOT.gov

Subject: 401 Water Quality Certification Pursuant to Section 401 of the Federal Clean Water Act with ADDITIONAL CONDITIONS for Proposed improvements to McKee Road in Matthews, Mecklenburg County, STIP# U-4713A, NCDWR Project No. 20240513.

Dear Mr. Howard

Attached hereto is a copy of Certification No. GC4246 issued to The North Carolina Department of Transportation (NCDOT) dated June 13, 2024.

This approval is for the purpose and design described in your application. The plans and specifications for this project are incorporated by reference as part of this Water Quality Certification. If you change your project, you must notify the Division and you may be required to submit a new application package with the appropriate fee. If the property is sold, the new owner must be given a copy of this Certification and is responsible for complying with all conditions. [15A NCAC 02H .0507(d)(2)]. This Certification does not relieve the permittee of the responsibility to obtain all other required Federal, State, or Local approvals before proceeding with the project, including those required by, but not limited to, Sediment and Erosion Control, Non-Discharge, Water Supply Watershed, and Trout Buffer regulations.

This letter completes the review of the Division under section 401 of the Clean Water Act and 15A NCAC 02H .0500. Please contact Mary Plummer at 704-235-2193 or Mary.Plummer@deq.nc.gov if you have any questions or concerns.

Sincerely,

DocuSigned by:

Amy Chapman

9C9086312DCD474...

Richard E. Rogers, Jr, Director
Division of Water Resources

Attachments

Electronic copy only distribution:

Chris Tinklenberg, Kimley-Horn
Steve Brumagin, US Army Corp of Engineers, Charlotte Regulatory Field Office
Rebekah Reid, US Fish and Wildlife Service
David McHenry, NC Wildlife Resources Commission
File Copy



North Carolina Department of Environmental Quality | Division of Water Resources
512 North Salisbury Street | 1617 Mail Service Center | Raleigh, North Carolina 27699-1617
919.707.9000

401 Water Quality Certification Pursuant to Section 401 of the Federal Clean Water Act with ADDITIONAL CONDITIONS

THIS CERTIFICATION is issued in conformity with the requirements of Section 401 Public Laws 92-500 and 95-217 of the United States and subject to the North Carolina Division of Water Resources (NCDWR) Regulations in 15 NCAC 2H.0500. This certification authorizes the NCDOT to impact 393 linear feet of jurisdictional streams, in Mecklenburg County. The project shall be constructed pursuant to the application dated and received April 22, 2024. The authorized impacts are as described below:

Stream Impacts in the Catawba River Basin (Linear Feet)

Site	Stream Impacts	Perm Fill in Perennial Stream	Temp Fill in Perennial Stream	Perm Fill in Intermittent Stream		Temp Fill in Intermittent Stream	Total Stream Impacts	Stream Impacts Requiring Mitigation
		Culvert	Dike/Pump	Culvert	Rip Rap	Dike/Pump		
S1	Stream 1	185	-	-	-	-	185	185
S2	Stream 1	-	18	-	-	-	18	-
S3	Stream 2	-	-	155	-	-	155	155
S4	Stream 2	-	-	-	-	7	7	-
S5	Stream 3	-	-	-	15	-	15	15
S6	Stream 3	-	-	-	-	13	13	-
Totals		185	18	155	15	20	393	355

Total Stream Impacts for Project: 393 Linear Feet.

The application provides adequate assurance that the discharge of fill material into the waters of the Catawba River Basin in conjunction with the proposed development will not result in a violation of applicable Water Quality Standards and discharge guidelines. Therefore, the State of North Carolina certifies that this activity will not violate the applicable portions of Sections 301, 302, 303, 306, 307 of PL 92-500 and PL 95-217 if conducted in accordance with the application and conditions hereinafter set forth.

This approval is only valid for the purpose and design that you submitted in your application dated and received April 22, 2024. Should your project change, you are required to notify the NCDWR and submit a new application. If the property is sold, the new owner must be given a copy of this Certification and approval letter and is thereby responsible for complying with all the conditions. If any additional wetland impacts, or stream impacts, for this project (now or in the future) exceed one acre or 150 linear feet, respectively, additional compensatory mitigation may be required as described in 15A NCAC 2H .0506 (h) (6) and (7).

For this approval to remain valid, you are required to comply with all the conditions listed below. In addition, you should obtain all other federal, state or local permits before proceeding with your project including (but not limited to) Sediment and Erosion control, Coastal Stormwater, Non-discharge and Water Supply watershed regulations. This Certification shall expire on the same day as the expiration date of the corresponding Corps of Engineers Permit.

This Water Quality Certification neither grants nor affirms any property right, license, or privilege in any lands or waters, or any right of use in any waters. This Water Quality Certification does not authorize any person to interfere with the riparian rights, littoral rights, or water use rights of any other person and does not create any prescriptive right or any right of priority regarding any usage of water. This Water Quality Certification shall not be interposed as a defense in any action respecting the determination of riparian or littoral rights or other rights to water use. No consumptive user is deemed by virtue of this Water Quality Certification to possess any prescriptive or other right of priority with respect to any other consumptive user regardless of the quantity of the withdrawal or the date on which the withdrawal was initiated or expanded. Upon the presentation of proper credentials, the



Division may inspect the property.

Condition(s) of Certification:

Project Specific Conditions

1. Design and placement of culverts and other structures shall be installed in such a manner that the original stream profiles are not altered (i.e., the depth of the channel must not be reduced by a widening of the streambed). Existing stream dimensions (including pattern and profile) are to be maintained above and below locations of each culvert. The structures shall be designed and installed to allow for fish and other wildlife movement as well as prevent headcutting of the stream. The applicant may be required to provide evidence that the equilibrium has been maintained if requested in writing by the NCDWR. [15A NCAC 02H.0506(b)(2)]
2. Unless otherwise approved in this certification, placement of culverts and other structures in open waters and streams, shall be placed below the elevation of the streambed by one foot for all culverts with a diameter greater than 48 inches, and 20 percent of the culvert diameter for culverts having a diameter less than 48 inches, to allow low flow passage of water and aquatic life. Design and placement of culverts and other structures including temporary erosion control measures shall not be conducted in a manner that may result in dis-equilibrium of wetlands or streambeds or banks, adjacent to or upstream and downstream of the above structures. The applicant is required to provide evidence that the equilibrium is being maintained if requested in writing by the NCDWR. If this condition is unable to be met due to bedrock or other limiting features encountered during construction, please contact the NCDWR for guidance on how to proceed and to determine whether or not a permit modification will be required. [15A NCAC 02H.0506(b)(2)]
3. If multiple pipes or barrels are required, they shall be designed to mimic natural stream cross sections as closely as possible including pipes or barrels at flood plain elevation and/or sills where appropriate. Widening the stream channel should be avoided. Stream channel widening at the inlet or outlet end of structures typically decreases water velocity causing sediment deposition that requires increased maintenance and disrupts aquatic life passage. [15A NCAC 02H.0506(b)(2)]
4. Riprap shall not be placed in the active thalweg channel or placed in the streambed in a manner that precludes aquatic life passage. Bioengineering boulders or structures should be properly designed, sized and installed. [15A NCAC 02H.0506(b)(2)]
5. The stream channel shall be excavated no deeper than the natural bed material of the stream, to the maximum extent practicable. Efforts must be made to minimize impacts to the stream banks, as well as to vegetation responsible for maintaining the stream bank stability. Any applicable riparian buffer impact for access to stream channel shall be temporary and be revegetated with native riparian species. [15A NCAC 02H.0506(b)(2)]
6. Any areas impacted by temporary clearing shall be stabilized and revegetated with native riparian seed/vegetation. [15A NCAC 02B.0506(b)(2)]
7. Compensatory mitigation for 355 linear feet of impact to streams is required. We understand that you have chosen to perform compensatory mitigation for impacts to streams through the North Carolina Division of Mitigation Service (DMS) (formerly NCEEP), and that the DMS has agreed to implement the mitigation for the project. The DMS has indicated in a letter dated April 12, 2024 that they will assume responsibility for satisfying the federal Clean Water Act compensatory mitigation requirements for the above-referenced project, in accordance with the DMS Mitigation Banking Instrument signed July 28, 2010.

General Conditions



1. If concrete is used during construction, a dry work area shall be maintained to prevent direct contact between curing concrete and surface water. Water that inadvertently contacts uncured concrete shall not be discharged to surface waters due to the potential for elevated pH and possible aquatic life and fish kills. [15A NCAC 02B.0200]
2. For any streams being impacted due to site dewatering activities, the site shall be graded to its preconstruction contours and revegetated with appropriate native species. [15A NCAC 02H.0506(b)(2)]
3. During the construction of the project, no staging of equipment of any kind is permitted in waters of the U.S. or protected riparian buffers. [15A NCAC 02H.0506(b)(2)]
4. The dimensions, pattern, and profile of streams above and below crossings shall not be modified. Disturbed floodplains and streams shall be restored to natural geomorphic conditions. [15A NCAC 02H.0506(b)(2)]
5. The use of riprap above the Normal High-Water Mark shall be minimized. Any riprap placed for stream stabilization shall be placed in stream channels in such a manner that it does not impede aquatic life passage. [15A NCAC 02H.0506(b)(2)]
6. The Permittee shall ensure that the final design drawings adhere to the permit and to the permit drawings submitted for approval. [15A NCAC 02H .0507 (c) and 15A NCAC 02H .0506 (b)(2) and (c)(2)]
7. All work in or adjacent to stream waters shall be conducted in a dry work area. Approved BMP measures from the most current version of NCDOT Construction and Maintenance Activities manual such as sandbags, rock berms, cofferdams and other diversion structures shall be used to prevent excavation in flowing water. [15A NCAC 02H.0506(b)(3) and (c)(3)]
8. Heavy equipment shall be operated from the banks rather than in the stream channel in order to minimize sedimentation and reduce the introduction of other pollutants into the stream. [15A NCAC 02H.0506(b)(3)]
9. All mechanized equipment operated near surface waters must be regularly inspected and maintained to prevent contamination of stream waters from fuels, lubricants, hydraulic fluids, or other toxic materials. [15A NCAC 02H.0506(b)(3)]
10. No rock, sand or other materials shall be dredged from the stream channel except where authorized by this certification. [15A NCAC 02H.0506(b)(3)]
11. Discharging hydroseed mixtures and washing out hydro seeders and other equipment in or adjacent to surface waters is prohibited. [15A NCAC 02H.0506(b)(3)]
12. The permittee and its authorized agents shall conduct its activities in a manner consistent with State water quality standards (including any requirements resulting from compliance with §303(d) of the Clean Water Act) and any other appropriate requirements of State and Federal law. If the NCDWR determines that such standards or laws are not being met (including the failure to sustain a designated or achieved use) or that State or federal law is being violated, or that further conditions are necessary to assure compliance, the NCDWR may reevaluate and modify this certification. [15A NCAC 02B.0200]
13. All fill slopes located in jurisdictional wetlands shall be placed at slopes no flatter than 3:1, unless otherwise authorized by this certification. [15A NCAC 02H.0506(b)(2)]
14. A copy of this Water Quality Certification shall be maintained on the construction site at all times. In addition, the Water Quality Certification, and all subsequent modifications, if any, shall be maintained w the Engineer and the on-site project manager. [15A NCAC 02H .0507(c) and 15A NCAC 02H .0506 (b)(2) and (c)(2)]



15. The outside buffer, wetland or water boundary located within the construction corridor approved by this authorization, including all non-commercial borrow and waste sites associated with the project, shall be clearly marked by highly visible fencing prior to any land disturbing activities. Impacts to areas within the fencing are prohibited unless otherwise authorized by this certification. [15A NCAC 02H.0501 and .0502]
16. The issuance of this certification does not exempt the Permittee from complying with any and all statutes, rules, regulations, or ordinances that may be imposed by other government agencies (i.e. local, state, and federal) having jurisdiction, including but not limited to applicable buffer rules, stormwater management rules, soil erosion and sedimentation control requirements, etc.
17. The Permittee shall report any violations of this certification to the Division of Water Resources within 24 hours of discovery. [15A NCAC 02B.0506(b)(2)]
18. Upon completion of the project (including any impacts at associated borrow or waste sites), the NCDOT Division Engineer shall complete and return the enclosed "Certification of Completion Form" to notify the NCDWR when all work included in the 401 Certification has been completed. [15A NCAC 02H.0502(f)]
19. Native riparian vegetation must be reestablished in the riparian areas within the construction limits of the project by the end of the growing season following completion of construction. [15A NCAC 02B.0506(b)(2)]
20. There shall be no excavation from, or waste disposal into, jurisdictional wetlands or waters associated with this permit without appropriate modification. Should waste or borrow sites, or access roads to waste or borrow sites, be located in wetlands or streams, compensatory mitigation will be required since that is a direct impact from road construction activities. [15A NCAC 02H.0506(b)(3) and (c)(3)]
21. Erosion and sediment control practices must be in full compliance with all specifications governing the proper design, installation and operation and maintenance of such Best Management Practices in order to protect surface waters standards [15A NCAC 02H.0506(b)(3) and (c)(3):
 - a. The erosion and sediment control measures for the project must be designed, installed, operated, and maintained in accordance with the most recent version of the *North Carolina Sediment and Erosion Control Planning and Design Manual*.
 - b. The design, installation, operation, and maintenance of the sediment and erosion control measures must be such that they equal, or exceed, the requirements specified in the most recent version of the *North Carolina Sediment and Erosion Control Manual*. The devices shall be maintained on all construction sites, borrow sites, and waste pile (spoil) projects, including contractor-owned or leased borrow pits associated with the project.
 - c. For borrow pit sites, the erosion and sediment control measures must be designed, installed, operated, and maintained in accordance with the most recent version of the *North Carolina Surface Mining Manual*.
 - d. The reclamation measures and implementation must comply with the reclamation in accordance with the requirements of the Sedimentation Pollution Control Act.
22. Sediment and erosion control measures shall not be placed in wetlands or surface waters, or within 5 feet of the top of bank, without prior approval from DWR. [15A NCAC 02H.0506(b)(3) and (c)(3)]
23. When applicable, all construction activities shall be performed and maintained in full compliance with G.S. Chapter 113A Article 4 (Sediment and Pollution Control Act of 1973). Regardless of applicability of the Sediment and Pollution Control Act, all projects shall incorporate appropriate Best Management Practices for the control of sediment and erosion so that no violations of state water quality standards, statutes, or rules occur. [15A NCAC 02H .0506 {b)(3) and (c)(3) and 15A NCAC 02B .0200]
24. Design, installation, operation, and maintenance of all sediment and erosion control measures shall be equal to or exceed the requirements specified in the most recent version of the *North Carolina Sediment and Erosion Control Manual*.



- 25. All devices shall be maintained on all construction sites, borrow sites, and waste pile (spoil) sites, including contractor-owned or leased borrow pits associated with the project. Sufficient materials required for stabilization and/or repair of erosion control measures and stormwater routing and treatment shall be on site at all times.
- 26. For borrow pit sites, the erosion and sediment control measures shall be designed, installed, operated, and maintained in accordance with the most recent version of the *North Carolina Surface Mining Manual*. Reclamation measures and implementation shall comply with the reclamation in accordance with the requirements of the Sedimentation Pollution Control Act and the Mining Act of 1971.

This approval and its conditions are final and binding unless contested [G.S. 143-215.5]. Please be aware that impacting waters without first applying for and securing the issuance of a 401 Water Quality Certification violates Title 15A of the North Carolina Administrative Code (NCAC) 2H .0500. Title 15A NCAC 2H .0500 requires certifications pursuant to Section 401 of the Clean Water Act whenever construction or operation of facilities will result in a discharge into navigable waters, including wetlands, as described in 33 Code of Federal Regulations (CFR) Part 323. It also states any person desiring issuance of the State certification or coverage under a general certification required by Section 401 of the Federal Water Pollution Control Act shall file with the Director of the North Carolina Division of Water Quality. Pursuant to G.S. 143-215.6A, these violations and any future violations are subject to a civil penalty assessment of up to a maximum of \$25,000.00 per day for each violation.

This Certification can be contested as provided in Chapter 150B of the North Carolina General Statutes by filing a Petition for a Contested Case Hearing (Petition) with the North Carolina Office of Administrative Hearings (OAH) **within sixty (60) calendar days**. Requirements for filing a Petition are set forth in Chapter 150B of the North Carolina General Statutes and Title 26 of the North Carolina Administrative Code. Additional information regarding requirements for filing a Petition and Petition forms may be accessed at <http://www.ncoah.com/> or by calling the OAH Clerk's Office at (919) 431-3000.

A party filing a Petition must serve a copy of the Petition on:
 William F. Lane, General Counsel
 Department of Environmental Quality
 1601 Mail Service Center
 Raleigh, NC 27699-1601

If the party filing the Petition is not the permittee, then the party must also serve the recipient of the Certification in accordance with N.C.G.S 150B-23(a).

This the 13th day of June 2024

DIVISION OF WATER RESOURCES

DocuSigned by:

 9C9886312DCD474...
 Richard E. Rogers, Jr, Director

WQC No. 4246



**STATE OF NORTH CAROLINA
DEPARTMENT OF ENVIRONMENTAL QUALITY
DIVISION OF WATER RESOURCES**

WATER QUALITY GENERAL CERTIFICATION NO. 4246

**GENERAL CERTIFICATION FOR PROJECTS ELIGIBLE FOR US ARMY CORPS OF ENGINEERS
NATIONWIDE PERMIT NUMBER 14 (LINEAR TRANSPORTATION PROJECTS)**

Water Quality General Certification Number 4246 is issued in conformity with the requirements of Section 401, Public Laws 92-500 and 95-217 of the United States and subject to the North Carolina Regulations in 15A NCAC 02H .0500 and 15A NCAC 02B .0200 for the discharge of fill material to surface waters and wetland areas as described in 33 CFR 330 Appendix A (B) (14) of the US Army Corps of Engineers regulations.

The State of North Carolina certifies that the specified category of activity will comply with water quality requirements and applicable portions of Sections 301, 302, 303, 306 and 307 of the Public Laws 92-500 and 95-217 if conducted in accordance with the conditions hereinafter set forth.

Effective date: February 25, 2022

Signed this day: December 18, 2020

By



S. Daniel Smith
Director

P-47
GC4246

GENERAL CERTIFICATION COVERAGE:

Activities that are eligible for US Army Corps of Engineers Nationwide Permit 14 qualify for coverage under this General Certification unless they meet one of the thresholds listed below. Activities meeting any one (1) of the thresholds or circumstances listed below are not eligible for coverage under this General Certification and require an Individual 401 Water Quality Certification from the Division of Water Resources (DWR):

- a) If any of the conditions of this General Certification cannot be met; or
 - b) Total permanent impacts to streams greater than 40 linear feet, except for construction of a driveway to a single family residential lot that is determined to not be part of a larger common plan of development, as long as the driveway involves a travel lane of less than 25 feet and total stream impacts of less than 60 feet, including any topographic/slope stabilization or in-stream stabilization needed for the crossing; or
 - c) Total temporary impacts to wetlands or open waters equal to or greater than one-tenth (1/10) of an acre; or
 - d) Any permanent impacts to wetlands or open waters; or
 - e) Any impacts to streams from excavation or dredging other than excavation that is conducted as preparation for installing permanent fill or structures; or
 - f) Any stream restoration or relocation other than stream relocations that are conducted for the purpose of proper culvert installation, alignment, protection, repair or maintenance where the relocation length is equal to or less than 50 feet in length and the relocated stream is designed and installed based on current natural channel techniques; or
 - g) Any high-density project, as defined in 15A NCAC 02H .1003(3) and by the density thresholds specified in 15A NCAC 02H .1017, which:
 - i. Disturbs one acre or more of land (including a project that disturbs less than one acre of land that is part of a larger common plan of development or sale); and
 - ii. Has permanent wetland, stream, or open water impacts; and
 - iii. Is proposing new built-upon area; and
 - iv. Does not have a stormwater management plan reviewed and approved under a state stormwater program¹ or a state-approved local government stormwater program².
- Projects that have vested rights, exemptions, or other legacy rights or exemptions from state or locally-implemented stormwater programs and projects that satisfy state or locally-implemented stormwater programs through use of community in-lieu fee programs **require an Individual 401 Certification**; or
- h) Any permanent impacts to waters, or to wetlands adjacent to waters, designated as: ORW (including SAV), HQW (including PNA), SA, WS-I, WS-II, or North Carolina or National Wild and Scenic River; or

¹ e.g. Coastal Counties, HQW, ORW, or state-implemented Phase II NPDES

² e.g. Delegated Phase II NPDES, Water Supply Watershed, Nutrient-Sensitive Waters, or Universal Stormwater Management Program

P-48
GC4246

- i) Any permanent impacts to waters, or to wetlands adjacent to waters, designated as Trout except for driveway projects that are below threshold (b) above provided that:
 - i. The impacts are not adjacent to any existing structures
 - ii. All conditions of this General Certification can be met, including adherence to any moratoriums as stated in Condition II.9; and
 - iii. A *Notification of Work in Trout Watersheds Form* is submitted to the Division at least 60 days prior to commencement of work; or
- j) Any permanent impacts to coastal wetlands [15A NCAC 07H .0205], or Unique Wetlands (UWL) [15A NCAC 02B .0231]; or
- k) Any impacts to subject water bodies and/or state regulated riparian buffers along subject water bodies in the Neuse, Tar-Pamlico, or Catawba River Basins or in the Randleman Lake, Jordan Lake or Goose Creek Watersheds (or any other basin or watershed with State Regulated Riparian Area Protection Rules [Buffer Rules] in effect at the time of application) *unless*:
 - i. The activities are listed as “EXEMPT” or “DEEMED ALLOWABLE” from these rules; or
 - ii. A Buffer Authorization Certificate is issued by the NC Division of Coastal Management (DCM); or
 - iii. A Buffer Authorization Certificate, Certificate with Exception, or Minor Variance is issued by a delegated or designated local government implementing a state riparian buffer program pursuant to 143-215.23.

In accordance with 15A NCAC 02H .0503(f), the Director of the North Carolina Division of Water Resources may require submission of a formal application for Individual Certification for any project if it is deemed in the public’s best interest or determined that the project is likely to have a significant adverse effect upon water quality, including state or federally listed endangered or threatened aquatic species, or will degrade the waters so that existing uses of the waters or downstream waters are precluded.

This General Certification does not relieve the permittee of the responsibility to obtain all other required Federal, State, or Local approvals before proceeding with the project, including those required by, but not limited to, Sediment and Erosion Control, Non-Discharge, Water Supply Watershed, and Trout Buffer regulations.

This General Certification neither grants nor affirms any property right, license, or privilege in any waters, or any right of use in any waters. This General Certification does not authorize any person to interfere with the riparian rights, littoral rights, or water use rights of any other person and does not create any prescriptive right or any right of priority regarding any usage of water. This General Certification shall not be interposed as a defense in any action respecting the determination of riparian or littoral rights or other rights to water use. No consumptive user is deemed by virtue of this General Certification to possess any prescriptive or other right of priority with respect to any other consumptive user regardless of the quantity of the withdrawal or the date on which the withdrawal was initiated or expanded.

Upon the presentation of proper credentials, DWR may inspect the property.

P-49
GC4246

This General Certification shall expire on the same day as the expiration date of the corresponding Nationwide Permit. The conditions in effect on the date of issuance of Certification for a specific project shall remain in effect for the life of the project, regardless of the expiration date of this General Certification. This General Certification is rescinded when the US Army Corps of Engineers reauthorizes the corresponding Nationwide Permit or when deemed appropriate by the Director of the Division of Water Resources.

Non-compliance with or violation of the conditions herein set forth by a specific project may result in revocation of this General Certification for the project and may also result in criminal and/or civil penalties.

I. ACTIVITY SPECIFIC CONDITIONS:

1. If this Water Quality Certification is used to access residential, commercial or industrial building sites, then all parcels owned by the permittee that are part of the single and complete project authorized by this Certification must be buildable without additional impacts to streams or wetlands.

Citation: 15A NCAC 02H .0502(a);15A NCAC 02H .0506(b); 15A NCAC 02H .0507(c)

Justification: A project that affects waters shall not be permitted unless the existing uses, and the water quality to protect such uses, are protected. In determining that the proposed activity will comply with state water quality standards (including designated uses, numeric criteria, narrative criteria and the state's antidegradation policy), the Division must evaluate if the activity has avoided and minimized impacts to waters, would cause or contribute to a violation of standards or would result in secondary or cumulative impacts.

2. For road construction purposes, this Certification shall only be utilized from natural high ground to natural high ground.

Citation: 15A NCAC 02H .0502(a);15A NCAC 02H .0506(b); 15A NCAC 02H .0507(c)

Justification: A project that affects waters shall not be permitted unless the existing uses, and the water quality to protect such uses, are protected. In determining that the proposed activity will comply with state water quality standards (including designated uses, numeric criteria, narrative criteria and the state's antidegradation policy), the Division must evaluate if the activity has avoided and minimized impacts to waters, would cause or contribute to a violation of standards or would result in secondary or cumulative impacts.

3. Deed notifications or similar mechanisms shall be placed on all lots/parcels with retained jurisdictional wetlands, waters, and state regulated riparian buffers within the project boundaries in order to assure compliance with NC Water Quality Certification Rules (15A NCAC 02H .0500), NC Isolated Wetland Rules (15A NCAC 02H .1300), and/or State Regulated Riparian Buffer Rules (15A NCAC 02B .0200). These mechanisms shall be put in place at the time of recording of the property or individual parcels, whichever is appropriate.

Citation: 15A NCAC 02H .0502(a);15A NCAC 02H .0506(b); 15A NCAC 02H .0507(c)

P-50
GC4246

Justification: A project that affects waters shall not be permitted unless the existing uses, and the water quality to protect such uses, are protected. In determining that the proposed activity will comply with state water quality standards (including designated uses, numeric criteria, narrative criteria and the state's antidegradation policy), the Division must evaluate if the activity has avoided and minimized impacts to waters, would cause or contribute to a violation of standards or would result in secondary or cumulative impacts.

II. GENERAL CONDITIONS:

1. The permittee shall report to the DWR Regional Office any noncompliance with, and/or any violation of, stream or wetland standards [15A NCAC 02B .0200], including but not limited to sediment impacts to streams or wetlands. Information shall be provided orally within 24 hours (or the next business day if a weekend or holiday) from the time the permittee became aware of the non-compliance circumstances.

Citation: 15A NCAC 02H .0506(b); 15A NCAC 02H .0507(c)

Justification: Timely reporting of non-compliance is important in identifying and minimizing detrimental impacts to water quality and avoiding impacts due to water pollution that precludes any best use on a short-term or long-term basis.

2. No waste, spoil, solids, or fill of any kind shall occur in wetlands or waters beyond the footprint of the impacts (including temporary impacts); or beyond the thresholds established for use of this General Certification and Nationwide Permit.

Citation: 15A NCAC 02H .0506; 15A NCAC 02H .0507(c)

Justification: Surface water quality standards require that conditions of waters be suitable for all best uses provided for in state rule (including, at minimum: aquatic life propagation, survival, and maintenance of biological integrity; wildlife; secondary contact recreation; agriculture); and that activities must not cause water pollution that precludes any best use on a short-term or long-term basis.

3. All activities shall be in compliance with any applicable State Regulated Riparian Buffer Rules in Chapter 2B of Title 15A in the North Carolina Administrative Code.

Citation: 15A NCAC 02H .0506(b); 15A NCAC 02H .0507(c)

Justification: The referenced Riparian Buffer rules were adopted to address water quality impairments and further protect existing uses.

4. When applicable, all construction activities shall be performed and maintained in full compliance with G.S. Chapter 113A Article 4 (Sediment and Pollution Control Act of 1973). Regardless of applicability of the Sediment and Pollution Control Act, all projects shall incorporate appropriate Best Management Practices for the control of sediment and erosion so that no violations of state water quality standards, statutes, or rules occur.

P-51

GC4246

Design, installation, operation, and maintenance of all sediment and erosion control measures shall be equal to or exceed the requirements specified in the most recent version of the *North Carolina Sediment and Erosion Control Manual*, or for linear transportation projects, the *North Carolina Department of Transportation Sediment and Erosion Control Manual*.

All devices shall be maintained on all construction sites, borrow sites, and waste pile (spoil) sites, including contractor-owned or leased borrow pits associated with the project. Sufficient materials required for stabilization and/or repair of erosion control measures and stormwater routing and treatment shall be on site at all times.

For borrow pit sites, the erosion and sediment control measures shall be designed, installed, operated, and maintained in accordance with the most recent version of the *North Carolina Surface Mining Manual*. Reclamation measures and implementation shall comply with the reclamation in accordance with the requirements of the Sedimentation Pollution Control Act and the Mining Act of 1971.

If the project occurs in waters or watersheds classified as Primary Nursery Areas (PNAs), SA, WS-I, WS-II, High Quality Waters (HQW), or Outstanding Resource Waters (ORW), then the sedimentation and erosion control designs shall comply with the requirements set forth in 15A NCAC 04B .0124, *Design Standards in Sensitive Watersheds*.

Citation: 15A NCAC 02H .0506(b)(2); 15A NCAC 02H .0507(c); 15A NCAC02B .0200; 15A NCAC 02B .0231

Justification: A project that affects waters shall not be permitted unless the existing uses, and the water quality to protect such uses, are protected. Activities must not cause water pollution that precludes any best use on a short-term or long-term basis. As cited in Stream Standards: (2) Oils, deleterious substances, or colored or other wastes: only such amounts as shall not render the waters injurious to public health, secondary recreation, or to aquatic life and wildlife, or adversely affect the palatability of fish, aesthetic quality, or impair the waters for any designated uses; and (12) turbidity in the receiving water shall not exceed 50 Nephelometric Turbidity Units (NTU) in streams not designated as trout waters and 10 NTU in streams, lakes, or reservoirs designated as trout waters; for lakes and reservoirs not designated as trout waters, the turbidity shall not exceed 25 NTU; if turbidity exceeds these levels due to natural background conditions, the existing turbidity level shall not be increased. As cited in Wetland Standards: (1) Liquids, fill or other solids, or dissolved gases shall not be present in amounts that may cause adverse impacts on existing wetland uses; and (3) Materials producing color or odor shall not be present in amounts that may cause adverse impacts on existing wetland uses.

5. Sediment and erosion control measures shall not be installed in wetland or waters except within the footprint of temporary or permanent impacts otherwise authorized by this Certification. If placed within authorized impact areas, then placement of such measures shall not be conducted in a manner that results in dis-equilibrium of any wetlands, streambeds, or streambanks. Any silt fence installed within wetlands shall be removed from wetlands and the natural grade restored within two (2) months of the date that

P-52
GC4246

DEMLR or locally delegated program has released the specific area within the project to ensure wetland standards are maintained upon completion of the project.

Citation: 15A NCAC 02H .0506(b); 15A NCAC 02H .0507(c); 15A NCAC02B .0200; 15A NCAC 02B .0231

Justification: A project that affects waters shall not be permitted unless the existing uses, and the water quality to protect such uses, are protected. Activities must not cause water pollution that precludes any best use on a short-term or long-term basis. As cited in Stream Standards: (2) Oils, deleterious substances, or colored or other wastes: only such amounts as shall not render the waters injurious to public health, secondary recreation, or to aquatic life and wildlife, or adversely affect the palatability of fish, aesthetic quality, or impair the waters for any designated uses; and (12) turbidity in the receiving water shall not exceed 50 Nephelometric Turbidity Units (NTU) in streams not designated as trout waters and 10 NTU in streams, lakes, or reservoirs designated as trout waters; for lakes and reservoirs not designated as trout waters, the turbidity shall not exceed 25 NTU; if turbidity exceeds these levels due to natural background conditions, the existing turbidity level shall not be increased. As cited in Wetland Standards: (1) Liquids, fill or other solids, or dissolved gases shall not be present in amounts that may cause adverse impacts on existing wetland uses; and (3) Materials producing color or odor shall not be present in amounts that may cause adverse impacts on existing wetland uses.

6. Erosion control matting that incorporates plastic mesh and/or plastic twine shall not be used along streambanks or within wetlands.

Citation: 15A NCAC 02H .0506(b); 15A NCAC 02H .0507(c)

Justification: A project that affects waters shall not be permitted unless the existing uses (including aquatic life propagation and biological integrity), and the water quality to protect such uses, are protected. Protections are necessary to ensure any remaining surface waters or wetlands, and any surface waters or wetlands downstream, continue to support existing uses during and after project completion. The Division must evaluate if the activity has avoided and minimized impacts to waters, would cause or contribute to a violation of standards, or would result in secondary or cumulative impacts.

7. If the project is covered by NPDES Construction Stormwater Permit Number NCG010000 or NPDES Construction Stormwater Permit Number NCG250000, full compliance with permit conditions including the erosion & sedimentation control plan, inspections and maintenance, self-monitoring, record keeping and reporting requirements is required.

The North Carolina Department of Transportation (NCDOT) shall be required to be in full compliance with the conditions related to construction activities within the most recent version of their Individual NPDES Stormwater Permit Number NCS000250.

Citation: 15A NCAC 02H .0506(b); 15A NCAC 02H .0507(c); 15A NCAC 02B .0200; 15A NCAC 02B .0231

Justification: A project that affects waters shall not be permitted unless the existing uses, and the water quality to protect such uses, are protected. Activities must not cause water

P-53
GC4246

pollution that precludes any best use on a short-term or long-term basis. As cited in Stream Standards: (2) Oils, deleterious substances, or colored or other wastes: only such amounts as shall not render the waters injurious to public health, secondary recreation, or to aquatic life and wildlife, or adversely affect the palatability of fish, aesthetic quality, or impair the waters for any designated uses; and (12) turbidity in the receiving water shall not exceed 50 Nephelometric Turbidity Units (NTU) in streams not designated as trout waters and 10 NTU in streams, lakes, or reservoirs designated as trout waters; for lakes and reservoirs not designated as trout waters, the turbidity shall not exceed 25 NTU; if turbidity exceeds these levels due to natural background conditions, the existing turbidity level shall not be increased. As cited in Wetland Standards: (1) Liquids, fill or other solids, or dissolved gases shall not be present in amounts that may cause adverse impacts on existing wetland uses; and (3) Materials producing color or odor shall not be present in amounts that may cause adverse impacts on existing wetland uses.

8. All work in or adjacent to streams shall be conducted so that the flowing stream does not come in contact with the disturbed area. Approved best management practices from the most current version of the *NC Sediment and Erosion Control Manual*, or the *NC Department of Transportation Construction and Maintenance Activities Manual*, such as sandbags, rock berms, cofferdams, and other diversion structures shall be used to minimize excavation in flowing water.

Citation: 15A NCAC 02H .0506(b); 15A NCAC 02H .0507(c); 15A NCAC 02B .0200

Justification: Surface water quality standards require that conditions of waters be suitable for all best uses provided for in state rule, and that activities must not cause water pollution that precludes any best use on a short-term or long-term basis. As cited in Stream Standards: (2) Oils, deleterious substances, or colored or other wastes: only such amounts as shall not render the waters injurious to public health, secondary recreation, or to aquatic life and wildlife, or adversely affect the palatability of fish, aesthetic quality, or impair the waters for any designated uses; and (12) turbidity in the receiving water shall not exceed 50 Nephelometric Turbidity Units (NTU) in streams not designated as trout waters and 10 NTU in streams, lakes, or reservoirs designated as trout waters; for lakes and reservoirs not designated as trout waters, the turbidity shall not exceed 25 NTU; if turbidity exceeds these levels due to natural background conditions, the existing turbidity level shall not be increased.

9. If activities must occur during periods of high biological activity (e.g. sea turtle nesting, fish spawning, or bird nesting), then biological monitoring may be required at the request of other state or federal agencies and coordinated with these activities.

All moratoriums on construction activities established by the NC Wildlife Resources Commission (WRC), US Fish and Wildlife Service (USFWS), NC Division of Marine Fisheries (DMF), or National Marine Fisheries Service (NMFS) shall be implemented. Exceptions to this condition require written approval by the resource agency responsible for the given moratorium.

P-54
GC4246

Work within a designated trout watershed of North Carolina (as identified by the Wilmington District of the US Army Corps of Engineers), or identified state or federal endangered or threatened species habitat, shall be coordinated with the appropriate WRC, USFWS, NMFS, and/or DMF personnel.

Citation: 15A NCAC 02H .0506(b); 15A NCAC 02H .0507(c); 15A NCAC 04B .0125

Justification: In order to protect against impairment of water quality standards and best usage of receiving and downstream waters, water quality based management practices must be employed to protect against direct or indirect discharge of waste or other sources of water pollution. Surface water quality standards require that conditions of waters be suitable for all best uses provided for in state rule (including, at minimum: aquatic life propagation, survival, and maintenance of biological integrity, wildlife, secondary contact recreation, agriculture), and that activities must not cause water pollution that precludes any best use on a short-term or long-term basis.

10. In-stream structures installed to mimic natural channel geomorphology such as cross-vanes, sills, step-pool structures, etc. shall be designed and installed in such a manner that allow for continued aquatic life movement.

Citation: 15A NCAC 02H .0506(b); 15A NCAC 02H .0507(c)

Justification: Surface water quality standards require that conditions of waters be suitable for all best uses provided for in state rule, and that activities must not cause water pollution that precludes any best use on a short-term or long-term basis. Ensuring that in-stream structures are installed properly will ensure that surface water quality standards are met and conditions of waters are suitable for all best uses.

11. Culverts shall be designed and installed in such a manner that the original stream profiles are not altered and allow for aquatic life movement during low flows. The dimension, pattern, and profile of the stream above and below a pipe or culvert shall not be modified by widening the stream channel or by reducing the depth of the stream in connection with the construction activity. The width, height, and gradient of a proposed culvert shall be such as to pass the average historical low flow and spring flow without adversely altering flow velocity. If the width of the culvert is wider than the stream channel, the culvert shall include multiple boxes/pipes, baffles, benches and/or sills to maintain the natural width of the stream channel. If multiple culverts/pipes/barrels are used, low flows shall be accommodated in one culvert/pipe and additional culverts/pipes shall be installed such that they receive only flows above bankfull.

Placement of culverts and other structures in streams shall be below the elevation of the streambed by one foot for all culverts with a diameter greater than 48 inches, and 20% of the culvert diameter for culverts having a diameter less than or equal to 48 inches, to allow low flow passage of water and aquatic life. If the culvert outlet is submerged within a pool or scour hole and designed to provide for aquatic passage, then culvert burial into the streambed is not required.

P-55
GC4246

For structures less than 72" in diameter/width, and topographic constraints indicate culvert slopes of greater than 2.5% culvert burial is not required, provided that all alternative options for flattening the slope have been investigated and aquatic life movement/connectivity has been provided when possible (e.g. rock ladders, cross-vanes, sills, baffles etc.). Notification, including supporting documentation to include a location map of the culvert, culvert profile drawings, and slope calculations, shall be provided to DWR 30 calendar days prior to the installation of the culvert.

When bedrock is present in culvert locations, culvert burial is not required, provided that there is sufficient documentation of the presence of bedrock. Notification, including supporting documentation such as a location map of the culvert, geotechnical reports, photographs, etc. shall be provided to DWR a minimum of 30 calendar days prior to the installation of the culvert. If bedrock is discovered during construction, then DWR shall be notified by phone or email within 24 hours of discovery.

Installation of culverts in wetlands shall ensure continuity of water movement and be designed to adequately accommodate high water or flood conditions. When roadways, causeways, or other fill projects are constructed across FEMA-designated floodways or wetlands, openings such as culverts or bridges shall be provided to maintain the natural hydrology of the system as well as prevent constriction of the floodway that may result in destabilization of streams or wetlands.

The establishment of native woody vegetation and other soft stream bank stabilization techniques shall be used where practicable instead of rip-rap or other bank hardening methods.

Citation: 15A NCAC 02H .0506(b); 15A NCAC 02H .0507(c)

Justification: Surface water quality standards require that conditions of waters be suitable for all best uses provided for in state rule, and that activities must not cause water pollution that precludes any best use on a short-term or long-term basis. Ensuring that in-stream structures are installed properly will ensure that surface water quality standards are met and conditions of waters are suitable for all best uses.

12. Bridge deck drains shall not discharge directly into the stream. Stormwater shall be directed across the bridge and pre-treated through site-appropriate means to the maximum extent practicable (e.g. grassed swales, pre-formed scour holes, vegetated buffers, etc.) before entering the stream.

Citation: 15A NCAC 02H .0506(b); 15A NCAC 02H .0507(c)

Justification: Surface water quality standards require that conditions of waters be suitable for all best uses provided for in state rule and that activities must not cause water pollution that precludes any best use on a short-term or long-term basis. Ensuring that in-stream structures are installed properly will ensure that surface water quality standards are met and conditions of waters are suitable for all best uses.

P-56
GC4246

13. Application of fertilizer to establish planted/seeded vegetation within disturbed riparian areas and/or wetlands shall be conducted at agronomic rates and shall comply with all other Federal, State and Local regulations. Fertilizer application shall be accomplished in a manner that minimizes the risk of contact between the fertilizer and surface waters.

Citation: 15A 02H .0506(b); 15A NCAC 02H .0507(c); 15A NCAC 02B .0231

Justification: A project that affects waters shall not be permitted unless the existing uses, and the water quality to protect such uses, are protected. Activities must not cause water pollution that precludes any best use on a short-term or long-term basis. As cited in Stream Standards: (2) Oils, deleterious substances, or colored or other wastes: only such amounts as shall not render the waters injurious to public health, secondary recreation, or to aquatic life and wildlife, or adversely affect the palatability of fish, aesthetic quality, or impair the waters for any designated uses.

14. If concrete is used during construction, then all necessary measures shall be taken to prevent direct contact between uncured or curing concrete and waters of the state. Water that inadvertently contacts uncured concrete shall not be discharged to waters of the state.

Citation: 15A 02H .0506(b); 15A NCAC 02H .0507(c); 15A NCAC 02B .0200

Justification: A project that affects waters shall not be permitted unless the existing uses, and the water quality to protect such uses, are protected. Activities must not cause water pollution that precludes any best use on a short-term or long-term basis. As cited in Stream Standards: (2) Oils, deleterious substances, or colored or other wastes: only such amounts as shall not render the waters injurious to public health, secondary recreation, or to aquatic life and wildlife, or adversely affect the palatability of fish, aesthetic quality, or impair the waters for any designated uses.

15. All proposed and approved temporary fill and culverts shall be removed and the impacted area shall be returned to natural conditions within 60 calendar days after the temporary impact is no longer necessary. The impacted areas shall be restored to original grade, including each stream's original cross-sectional dimensions, planform pattern, and longitudinal bed profile. All temporarily impacted sites shall be restored and stabilized with native vegetation.

Citation: 15A NCAC 02H.0506(b); 15A NCAC 02H .0507(c)

Justification: A project that affects waters shall not be permitted unless the existing uses, and the water quality to protect such uses, are protected. Protections are necessary to ensure any remaining surface waters or wetlands, and any surface waters or wetlands downstream, continue to support existing uses after project completion.

16. All proposed and approved temporary pipes/culverts/rip-rap pads etc. in streams shall be installed as outlined in the most recent edition of the *North Carolina Sediment and Erosion Control Planning and Design Manual* or the *North Carolina Surface Mining Manual* or the *North Carolina Department of Transportation Best Management Practices for Construction and Maintenance Activities* so as not to restrict stream flow or cause dis-equilibrium during use of this General Certification.

P-57
GC4246

Citation: 15A NCAC 02H .0506(b); 15A NCAC 02H .0507(c)

Justification: Surface water quality standards require that conditions of waters be suitable for all best uses provided for in state rule, and that activities must not cause water pollution that precludes any best use on a short-term or long-term basis. Ensuring that in-stream structures are installed properly will ensure that surface water quality standards are met and conditions of waters are suitable for all best uses.

17. Any rip-rap required for proper culvert placement, stream stabilization, or restoration of temporarily disturbed areas shall be restricted to the area directly impacted by the approved construction activity. All rip-rap shall be placed such that the original streambed elevation and streambank contours are restored and maintained and shall consist of clean rock or masonry material free of debris or toxic pollutants. Placement of rip-rap or other approved materials shall not result in de-stabilization of the stream bed or banks upstream or downstream of the area or be installed in a manner that precludes aquatic life passage.

Citation: 15A NCAC 02H .0506(b); 15A NCAC 02H .0507(c)

Justification: Surface water quality standards require that conditions of waters be suitable for all best uses provided for in state rule, and that activities must not cause water pollution that precludes any best use on a short-term or long-term basis. The Division must evaluate if the activity has avoided and minimized impacts to waters, would cause or contribute to a violation of standards, or would result in secondary or cumulative impacts.

18. Any rip-rap used for stream or shoreline stabilization shall be of a size and density to prevent movement by wave, current action, or stream flows, and shall consist of clean rock or masonry material free of debris or toxic pollutants. Rip-rap shall not be installed in the streambed except in specific areas required for velocity control and to ensure structural integrity of bank stabilization measures.

Citation: 15A NCAC 02H .0506(b); 15A NCAC 02H .0507(c); 15A NCAC 02B .0201

Justification: Surface water quality standards require that conditions of waters be suitable for all best uses provided for in state rule, and that activities must not cause water pollution that precludes any best use on a short-term or long-term basis. The Division must evaluate if the activity has avoided and minimized impacts to waters, would cause or contribute to a violation of standards, or would result in secondary or cumulative impacts.

19. Rip-rap groins proposed in accordance with 15A NCAC 07H .1401 (NC Division of Coastal Management General Permit for construction of Wooden and Rip-rap Groins in Estuarine and Public Trust Waters) shall meet all the specific conditions for design and construction specified in 15A NCAC 07H .1405.

Citation: 15A NCAC 02H .0507(c); 15A NCAC 07H .1400 et seq.

Justification: Surface water quality standards require that conditions of waters be suitable for all best uses provided for in state rule, and that activities must not cause water pollution that precludes any best use on a short-term or long-term basis. The Division must evaluate if the activity has avoided and minimized impacts to waters, would cause or contribute to a violation of standards, or would result in secondary or cumulative impacts.

P-58
GC4246

20. All mechanized equipment operated near surface waters shall be inspected and maintained regularly to prevent contamination of surface waters from fuels, lubricants, hydraulic fluids, or other toxic materials. Construction shall be staged in order to minimize the exposure of equipment to surface waters to the maximum extent practicable. Fueling, lubrication, and general equipment maintenance shall be performed in a manner to prevent, to the maximum extent practicable, contamination of surface waters by fuels and oils.

Citation: 15A NCAC 02H .0506(b); 15A NCAC 02H .0507(c); 15A NCAC 02B .0200

Justification: A project that affects waters shall not be permitted unless the existing uses, and the water quality to protect such uses, are protected. Activities must not cause water pollution that precludes any best use on a short-term or long-term basis. As cited in Stream Standards: (2) Oils, deleterious substances, or colored or other wastes: only such amounts as shall not render the waters injurious to public health, secondary recreation, or to aquatic life and wildlife, or adversely affect the palatability of fish, aesthetic quality, or impair the waters for any designated uses.

21. Heavy equipment working in wetlands shall be placed on mats or other measures shall be taken to minimize soil disturbance and compaction.

Citation: 15A NCAC 02H .0506(b); 15A NCAC 02H .0507(c); 15A NCAC 02B .0231

Justification: Wetland standards require maintenance or enhancement of existing uses of wetlands such that hydrologic conditions necessary to support natural biological and physical characteristics are protected; populations of wetland flora and fauna are maintained to protect biological integrity of the wetland; and materials or substances are not present in amounts that may cause adverse impact on existing wetland uses.

22. In accordance with 143-215.85(b), the permittee shall report any petroleum spill of 25 gallons or more; any spill regardless of amount that causes a sheen on surface waters; any petroleum spill regardless of amount occurring within 100 feet of surface waters; and any petroleum spill less than 25 gallons that cannot be cleaned up within 24 hours.

Citation: 15A NCAC 02H .0507(c); N.C.G.S 143-215.85(b)

Justification: Person(s) owning or having control over oil or other substances upon notice of discharge must immediately notify the Department, or any of its agents or employees, of the nature, location, and time of the discharge and of the measures which are being taken or are proposed to be taken to contain and remove the discharge. This action is required in order to contain or divert the substances to prevent entry into the surface waters. Surface water quality standards require that conditions of waters be suitable for all best uses provided for in state rule (including, at minimum: aquatic life propagation, survival, and maintenance of biological integrity; wildlife; secondary contact recreation; agriculture); and that activities must not cause water pollution that precludes any best use on a short-term or long-term basis.

23. The permittee and their authorized agents shall conduct all activities in a manner consistent with State water quality standards (including any requirements resulting from compliance

P-59
GC4246

with §303(d) of the Clean Water Act), and any other appropriate requirements of State and Federal Law.

Citation: 15A NCAC 02H .0506(b); 15A NCAC 02H .0507(c)

Justification: Surface water quality standards require that conditions of waters be suitable for all best uses provided for in state rule, and that activities must not cause water pollution that precludes any best use on a short-term or long-term basis. The Division must evaluate if the activity has avoided and minimized impacts to waters, would cause or contribute to a violation of standards, or would result in secondary or cumulative impacts.

24. The permittee shall require its contractors and/or agents to comply with the terms and conditions of this permit in the construction and maintenance of this project, and shall provide each of its contractors and/or agents associated with the construction or maintenance of this project with a copy of this General Certification. A copy of this General Certification shall be available at the project site during the construction and maintenance of this project.

Citation: 15A NCAC 02H .0506(b); 15A NCAC 02H .0507(c)

Justification: Those actually performing the work should be aware of the requirements of this 401 Water Quality General Certification to minimize water quality impacts.

History Note: Water Quality Certification (WQC) Number 4246 issued December 18, 2020 replaces WQC 4135 issued December 1, 2017 for activities eligible for USACE NWP14; WQC 4088 issued March 3, 2017; WQC 3886 issued March 12, 2012; WQC 3820 issued April 6, 2010; WQC 3627 issued March 19, 2007; WQC Number 3404 issued March 2003; WQC 3375 issued March 18, 2002; WQC 3289 issued June 1, 2000; WQC 3103 issued February 11, 1997; WQC Number 2732 issued May 1, 1992; WQC 2666 issued January 21, 1992; WQC 2177 issued November 5, 1987.

TIP PROJECT: U-4713A

See Sheet 14A For Index Of Sheets
See Sheet 1B For Conventional Symbols

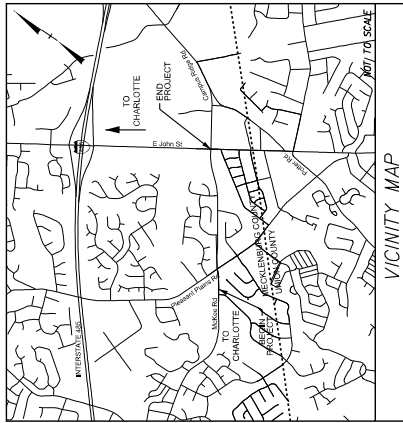

STATE OF NORTH CAROLINA
DIVISION OF HIGHWAYS
MECKLENBURG COUNTY

LOCATION: SR 3448 (PLEASANT PLAINS RD) TO SR 1009 (JOHN STREET)
TYPE OF WORK: GRADING, PAVING, DRAINAGE, AND CULVERT
WETLAND AND SURFACE WATER IMPACTS PERMIT

PERMIT DRAWING
SHEET 1 OF 8

STATE	FEDERAL AID DISTRICT NO.	ROUTE	SECTION
N.C.	U-4713A		I
DATE	DESCRIPTION	DATE	BY
39077.1.2	N/A		PE
39077.2.2	N/A		UTILITIES
39077.2.2	N/A		R/W
39077.3.2	N/A		CONSTRUCTION

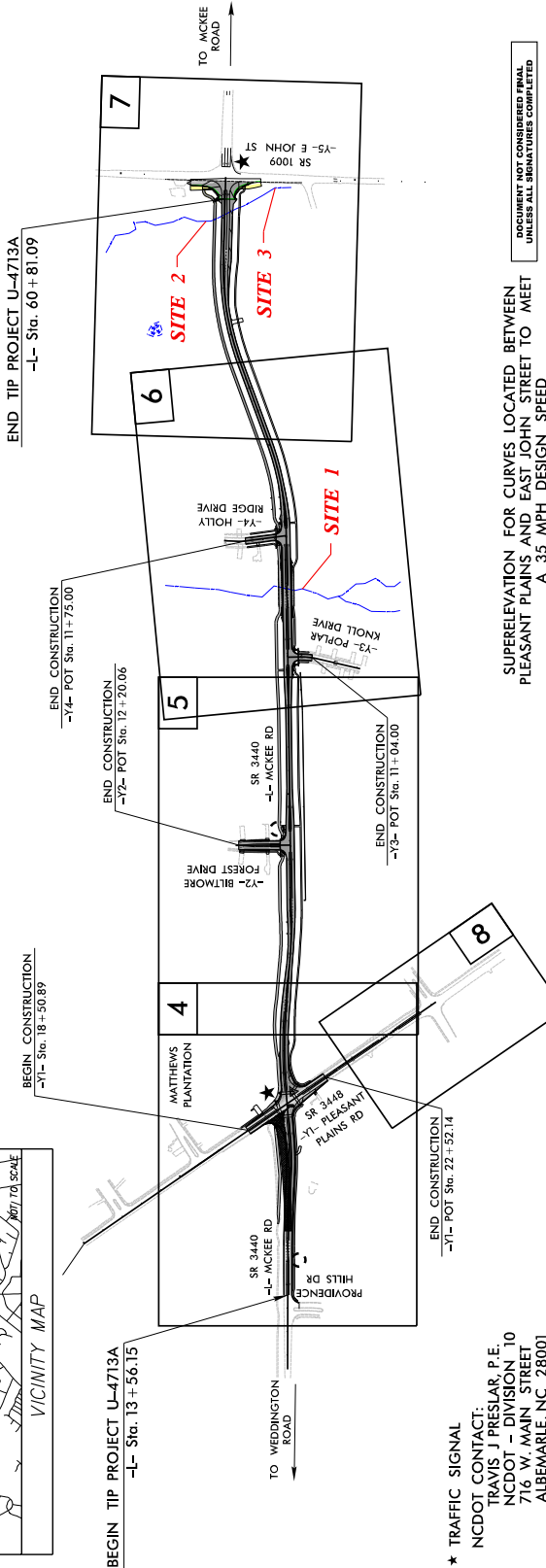

★ TRAFFIC SIGNAL

NCDOT CONTACT:
TRAVIS J PRESLAR, P.E.
NCDOT - DIVISION 10
716 W. MAIN STREET
ALBEMARLE, NC 28001

SUPERELEVATION FOR CURVES LOCATED BETWEEN
PLEASANT PLAINS AND EAST JOHN STREET TO MEET
A 35 MPH DESIGN SPEED

DOCUMENT NOT CONSIDERED FINAL
UNLESS ALL SIGNATURES COMPLETED

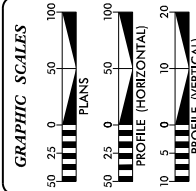

DESIGN DATA

ADT 2017	= 12,100 VPD
ADT 2040	= 17,000 VPD
K	= 8%
P	= 3%
V	= 40 MPH
FUNCTIONAL CLASSIFICATION	MINOR COLLECTOR
* 1% TEST 2% DUAL	SUB REGIONAL TIER

PROJECT LENGTH

LENGTH ROADWAY TIP PROJECT U-4713A	= 0.895 MILES
TOTAL LENGTH TIP PROJECT U-4713A	= 0.895 MILES

PLANS PREPARED FOR THE NCDOT BY:

200 STANDARD SPECIFICATIONS	FRANK J. MASTERSON, P.E. PROJECT ENGINEER
RIGHT OF WAY DATE:	ANDREW BEERS, E.L. PROJECT DESIGN ENGINEER
LETTING DATE:	TRAVIS J. PRESLAR, P.E. DMS-STEP PROJECT MANAGER

HYDRAULICS ENGINEER

STRUCTURE	ROADWAY DESIGN ENGINEER
SIGNATURE	P.E.

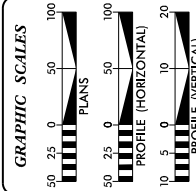
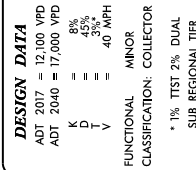
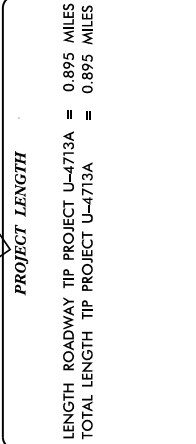
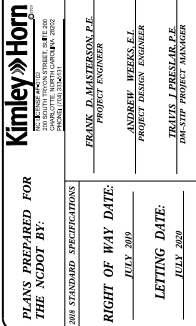
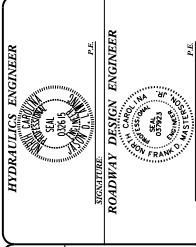

P-61

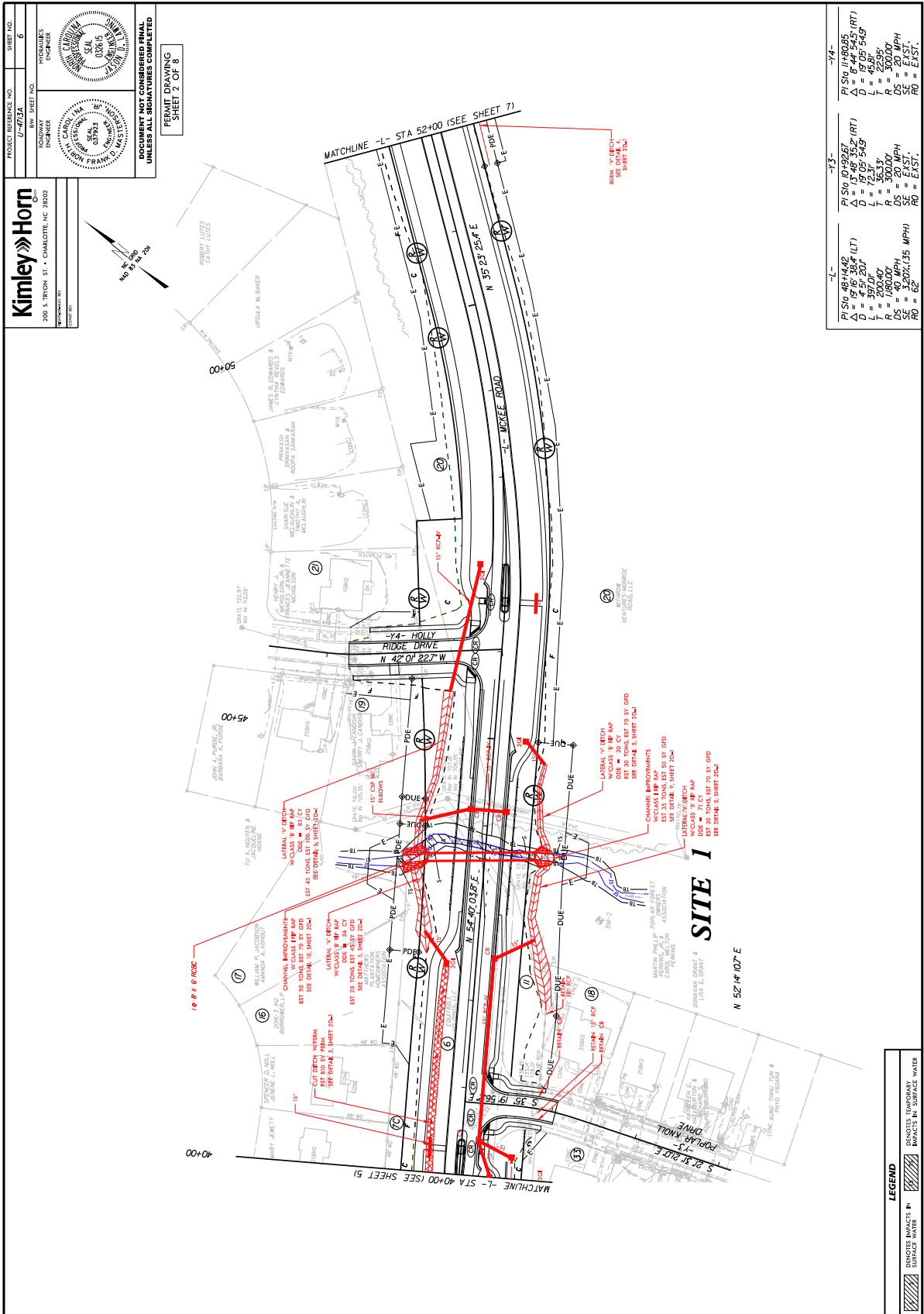

-L-	-Y3-	-Y4-
PI STA 48+14.42	PI STA 10+92.67	PI STA 1+80.85
$\Delta = 19' 16' 38.4''$ (LT)	$\Delta = 13' 46' 35.2''$ (RT)	$\Delta = 6' 44' 54.5''$ (RT)
D = 397.0'	D = 775.0'	D = 45.05'
T = 220.40'	T = 229.95'	T = 45.05'
R = 1,800.00'	R = 3,000.00'	R = 300.00'
SE = EAST	SE = EAST	SE = EAST
RO = 62'	RO = EAST	RO = EAST

LEGEND

-  DRAINAGE IMPACTS IN SURFACE WATER
-  IMPACTER TEMPORARY IMPACTS IN SURFACE WATER



PROJECT REFERENCE NO. U-4734 SHEET NO. 6

PROPOSED ENGINEER: KIMLEY-HORN ENGINEERS, INC. (Professional Seal: 02615)

EXISTING ENGINEER: KIMLEY-HORN ENGINEERS, INC. (Professional Seal: 03793)

STATEMENT: DOCUMENT NOT CONSIDERED FINAL UNLESS ALL SIGNATURES COMPLETED

DESIGN DRAWING: SHEET 2 OF 8

11/9/2023 K:\CML\PROJECTS\2023\23075 - McKee Rd Exp\Drawings\PMIT_S Environmental\Drawings\PlanSheet\4734_P61.dwg

REVISIONS

- REV 02/23/23 = REVISIONS FROM RFP MATING BIDDING/REMARK PACKETS & CDM
- REV 02/24/23 = UPDATES FROM AND EXEMPTS FOR NORTH WALK PACKET 23.1.00M
- REV 02/28/23 = CDM APPROVED BE BAR TO THE PROPOSED DRCH. PACKET 19.15M

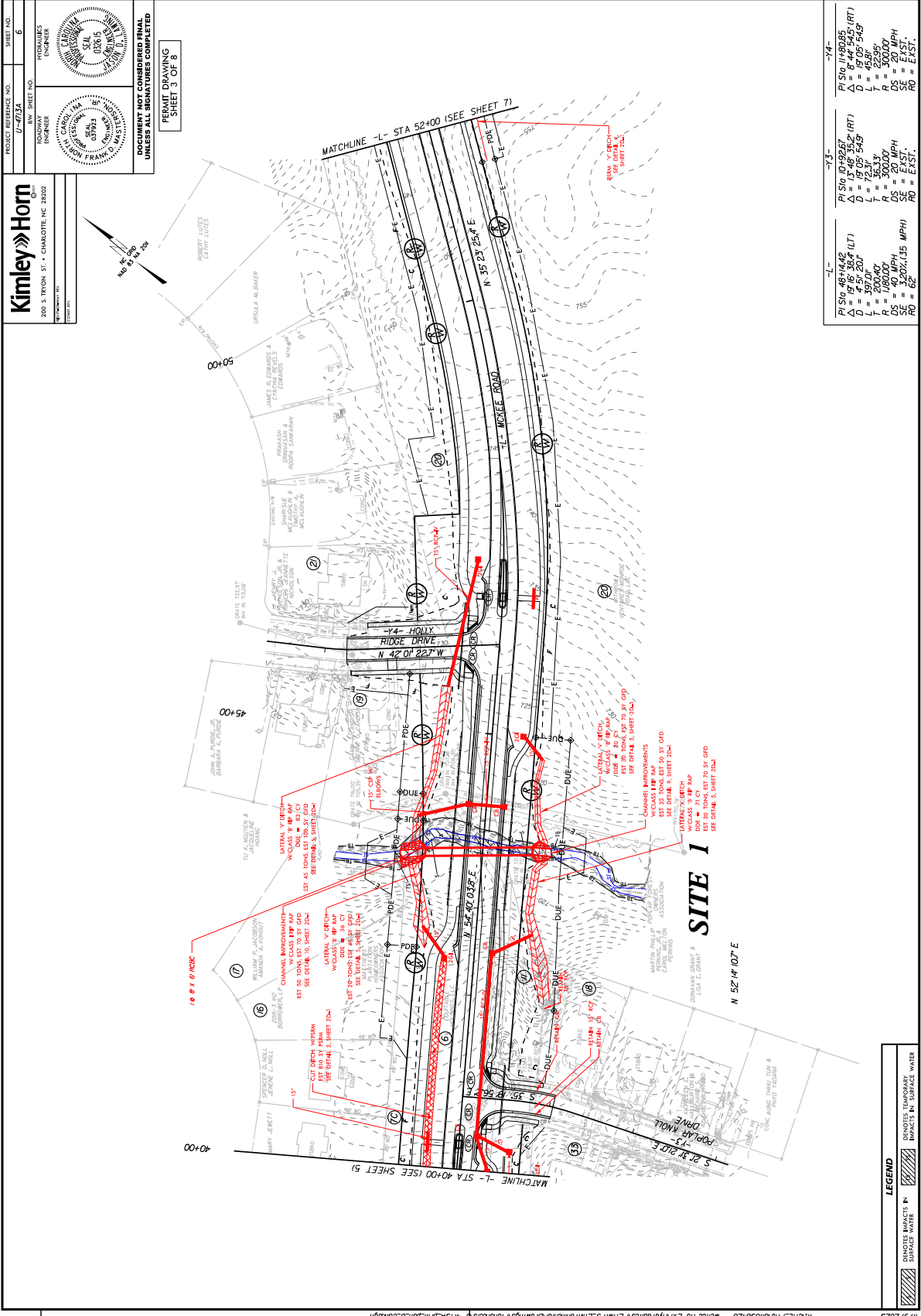

PROJECT REFERENCE NO. 07-4734
 SHEET NO. 6
 DATE 12/15/2023
 HORN FRAKOVICH ENGINEERING
 200 S. TRYON ST., CHARLOTTE, NC 28202
 (704) 999-1100
 www.hornfrakovich.com

DESIGNED BY: J. HORN
 CHECKED BY: J. HORN
 DATE: 12/15/2023

CONTRACT NO. 2023-01-0001

REVISIONS

REVISIONS FROM RFP MEETING (12/15/2023) - SEE REVISIONS FROM RFP MEETING (12/15/2023) - SEE REVISIONS FROM RFP MEETING (12/15/2023) - SEE REVISIONS FROM RFP MEETING (12/15/2023)

REVISIONS FROM RFP MEETING (12/15/2023) - SEE REVISIONS FROM RFP MEETING (12/15/2023) - SEE REVISIONS FROM RFP MEETING (12/15/2023) - SEE REVISIONS FROM RFP MEETING (12/15/2023)

REVISIONS FROM RFP MEETING (12/15/2023) - SEE REVISIONS FROM RFP MEETING (12/15/2023) - SEE REVISIONS FROM RFP MEETING (12/15/2023) - SEE REVISIONS FROM RFP MEETING (12/15/2023)

DESIGNED BY: J. HORN
 CHECKED BY: J. HORN
 DATE: 12/15/2023

CONTRACT NO. 2023-01-0001

PROJECT REFERENCE NO. 07-4734
 SHEET NO. 6
 DATE 12/15/2023
 HORN FRAKOVICH ENGINEERING
 200 S. TRYON ST., CHARLOTTE, NC 28202
 (704) 999-1100
 www.hornfrakovich.com

DESIGNED BY: J. HORN
 CHECKED BY: J. HORN
 DATE: 12/15/2023

CONTRACT NO. 2023-01-0001

REVISIONS

REVISIONS FROM RFP MEETING (12/15/2023) - SEE REVISIONS FROM RFP MEETING (12/15/2023) - SEE REVISIONS FROM RFP MEETING (12/15/2023) - SEE REVISIONS FROM RFP MEETING (12/15/2023)

REVISIONS FROM RFP MEETING (12/15/2023) - SEE REVISIONS FROM RFP MEETING (12/15/2023) - SEE REVISIONS FROM RFP MEETING (12/15/2023) - SEE REVISIONS FROM RFP MEETING (12/15/2023)

REVISIONS

REVISIONS FROM RFP MEETING (12/15/2023) - SEE REVISIONS FROM RFP MEETING (12/15/2023) - SEE REVISIONS FROM RFP MEETING (12/15/2023) - SEE REVISIONS FROM RFP MEETING (12/15/2023)

REVISIONS FROM RFP MEETING (12/15/2023) - SEE REVISIONS FROM RFP MEETING (12/15/2023) - SEE REVISIONS FROM RFP MEETING (12/15/2023) - SEE REVISIONS FROM RFP MEETING (12/15/2023)

REVISIONS

REVISIONS FROM RFP MEETING (12/15/2023) - SEE REVISIONS FROM RFP MEETING (12/15/2023) - SEE REVISIONS FROM RFP MEETING (12/15/2023) - SEE REVISIONS FROM RFP MEETING (12/15/2023)

REVISIONS FROM RFP MEETING (12/15/2023) - SEE REVISIONS FROM RFP MEETING (12/15/2023) - SEE REVISIONS FROM RFP MEETING (12/15/2023) - SEE REVISIONS FROM RFP MEETING (12/15/2023)

-L-	-Y3-	-Y4-
PI STA 48+14.42 Δ = 19' 16" 35.4' (LTI) D = 597.0' 20.7' T = 22.95' R = 200.00' SE = EAST RO = 62'	PI STA 10+92.67 Δ = 13' 46" 35.2' (RTI) D = 75.0' 54.9' T = 22.95' R = 300.00' SE = EAST RO = 62'	PI STA 11+80.85 Δ = 6' 44" 54.5' (RTI) D = 45.0' 54.9' T = 22.95' R = 300.00' SE = EAST RO = 62'

LEGEND

BRACKET MARKETS IN SURFACE WATER

IMPACTS IN SURFACE WATER

REVISIONS



REVISIONS FROM RFP MEETING (12/15/2023) - SEE REVISIONS FROM RFP MEETING (12/15/2023) - SEE REVISIONS FROM RFP MEETING (12/15/2023) - SEE REVISIONS FROM RFP MEETING (12/15/2023)

REVISIONS FROM RFP MEETING (12/15/2023) - SEE REVISIONS FROM RFP MEETING (12/15/2023) - SEE REVISIONS FROM RFP MEETING (12/15/2023) - SEE REVISIONS FROM RFP MEETING (12/15/2023)

REVISIONS

REVISIONS FROM RFP MEETING (12/15/2023) - SEE REVISIONS FROM RFP MEETING (12/15/2023) - SEE REVISIONS FROM RFP MEETING (12/15/2023) - SEE REVISIONS FROM RFP MEETING (12/15/2023)

REVISIONS FROM RFP MEETING (12/15/2023) - SEE REVISIONS FROM RFP MEETING (12/15/2023) - SEE REVISIONS FROM RFP MEETING (12/15/2023) - SEE REVISIONS FROM RFP MEETING (12/15/2023)

PROJECT REFERENCE NO. U-473A	SHEET NO.
ENV. SHEET NO.	HYDRAULICS ENGINEER
	

Kimley-Horn
 200 S. TRYON ST. • CHARLOTTE, NC 28202
 (704) 366-9700
 www.kimley-horn.com

SITE 1

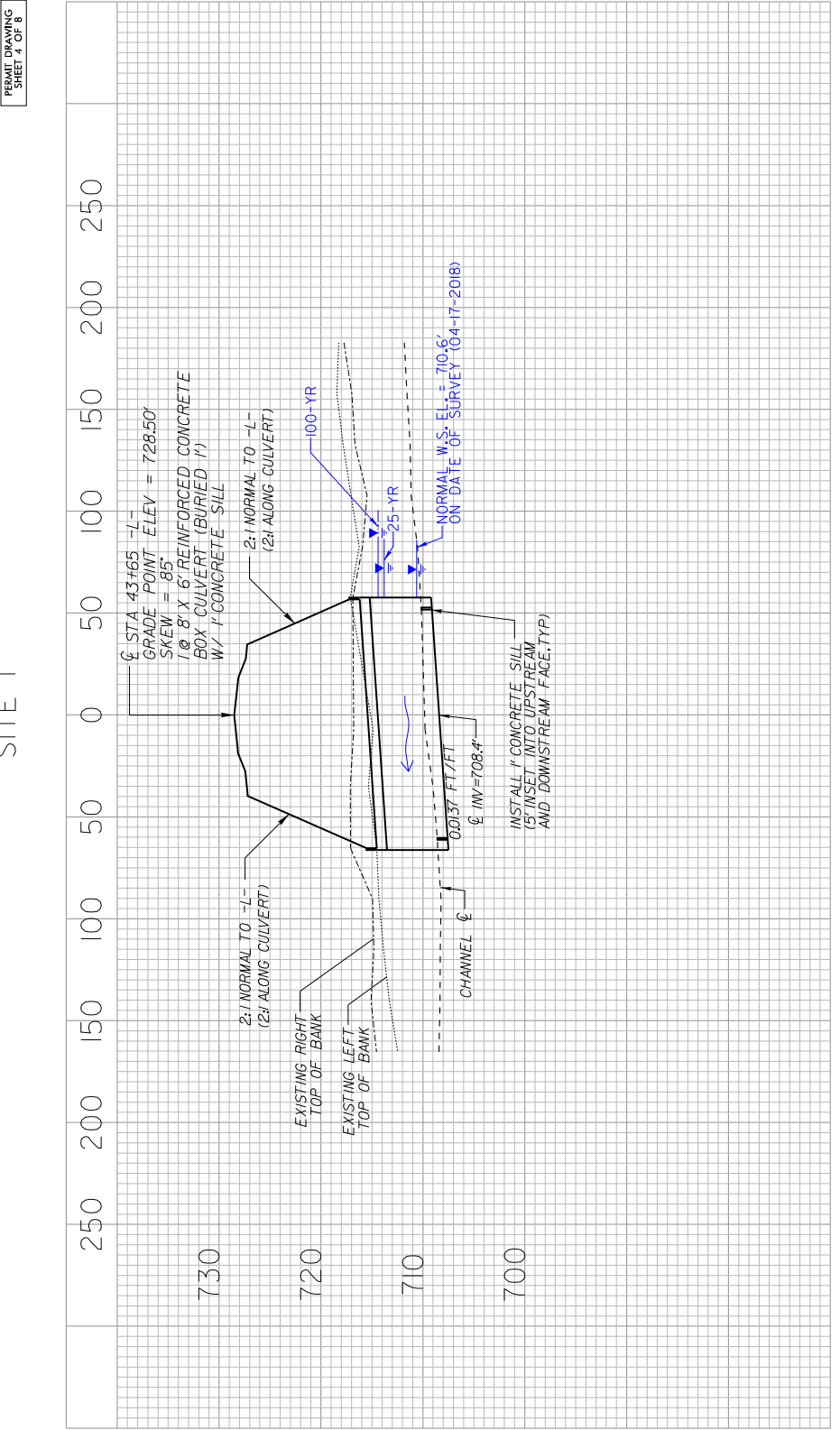

PERMIT DRAWING
SHEET 4 OF 8

NO.	DATE	REVISIONS

Kimley-Horn
 200 S. TRYON ST. • CHARLOTTE, NC 28202
 (704) 366-7700
 WWW.KIMLEY-HORN.COM

PROJECT REFERENCE NO. U-4724
 SHEET NO. 7
 CIVIL ENGINEER
 HYDRAULICS ENGINEER
 PERMIT DRAWING
 SHEET 5 OF 8
 DOCUMENT NOT CONSIDERED FINAL
 UNLESS ALL SIGNATURES COMPLETED

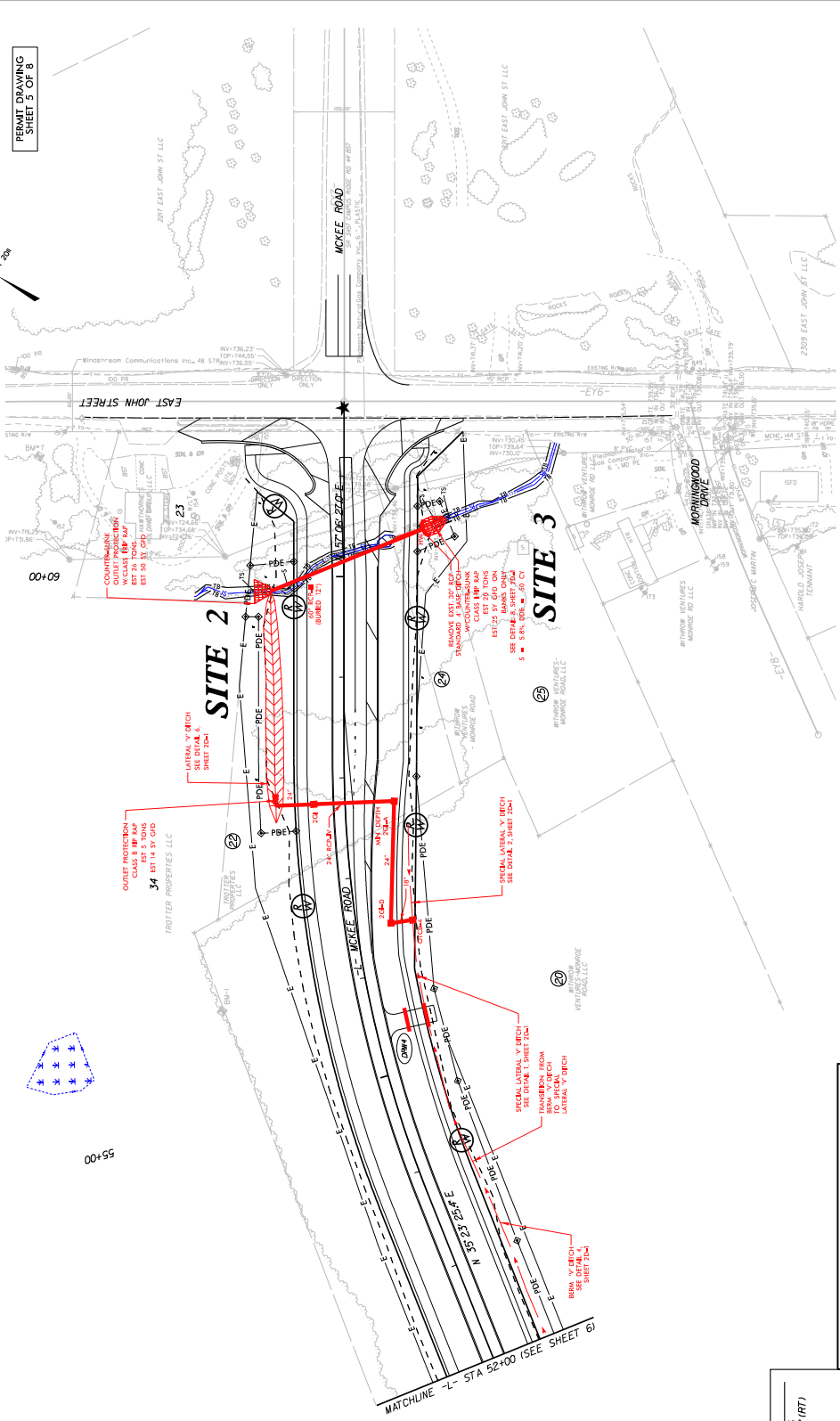

55+00

00+09

SITE 2

SITE 3

MATCHLINE -L- STA 52+00 (SEE SHEET 6)

-L-
 P/S 50 55+00/35
 $\Delta = 27.43^\circ 01.6' (RT)$
 $D = 4.25' 20.7''$
 $T = 226.35'$
 $R = 1160.00'$
 $S = 3.20\% (1.35 \text{ MPH})$
 $R_0 = 62'$

LEGEND
 [Symbol] DRAINAGE TEMPORARY
 [Symbol] IMPACTS IN SURFACE WATER
 [Symbol] IMPACTS IN SURFACE WATER

REVISIONS
 ROW REV 02/23/19 - REVISIONS FROM MEETING - (EQUIPMENT AND EXISTING PAVEMENT) 23' ROW
 KIMLEY-HORN, INC. 4713A CRM, REV. 7/2019

11/9/2023

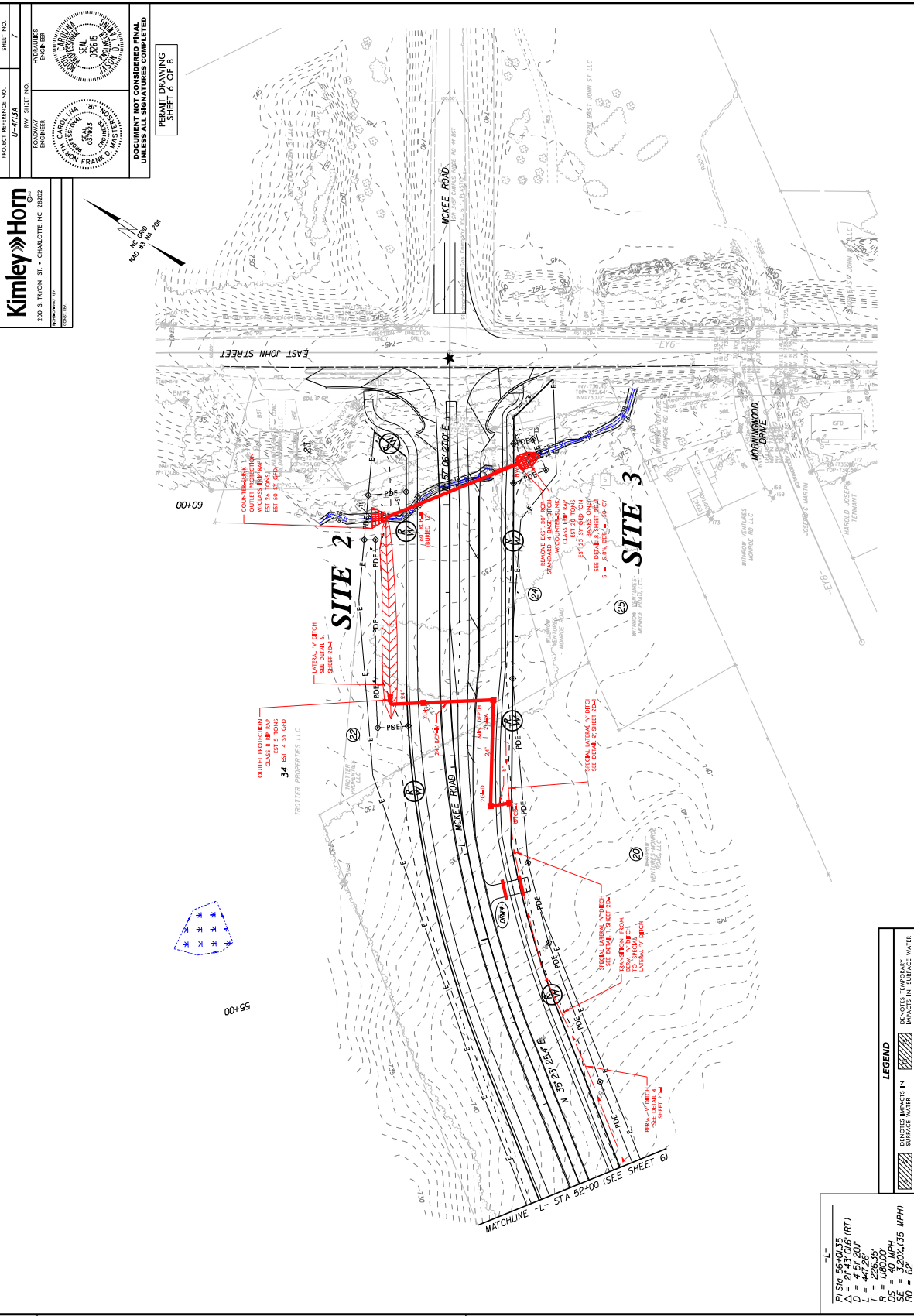

Kimley»Horn
 200 S. TRYON ST. • CHARLOTTE, NC 28202
 (704) 366-7700
 kimley-horn.com

PROJECT REFERENCE NO. U-4724
 SHEET NO. 7
 CIVIL ENGINEER
 HYDRAULICS ENGINEER
 PROFESSIONAL SEAL
 032615
 PROFESSIONAL SEAL
 037823
 JOHN FRANKLIN
 STATE OF NORTH CAROLINA
 REGISTERED PROFESSIONAL ENGINEER

STATEMENT NOT CONSIDERED FINAL
 UNLESS ALL SIGNATURES COMPLETED
 PRELIMINARY DRAWING
 SHEET 7 OF 8



$P/SIN = 5640/35$
 $\Delta = 27.43^\circ 01.6' (RT)$
 $D = 4.25' 20"$
 $T = 226.35'$
 $R = 1160.00'$
 $SS = 3.207(.135 \text{ MPH})$
 $RO = 62'$

LEGEND
 [Symbol] BRACKETS IMPACTS BY SURFACE WATER
 [Symbol] BRACKETS TEMPORARY IMPACTS IN SURFACE WATER

REVISIONS
 ROW REV 02/23/19 - REVISIONS FROM MEETING - (EQUIPMENT FOR AND EXISTING PAVEMENT 23' WIDE)
 KIMLEY-HORN ENGINEERING, INC. - 4715A CORMORANT DRIVE, CHARLOTTE, NC 28226

P-66

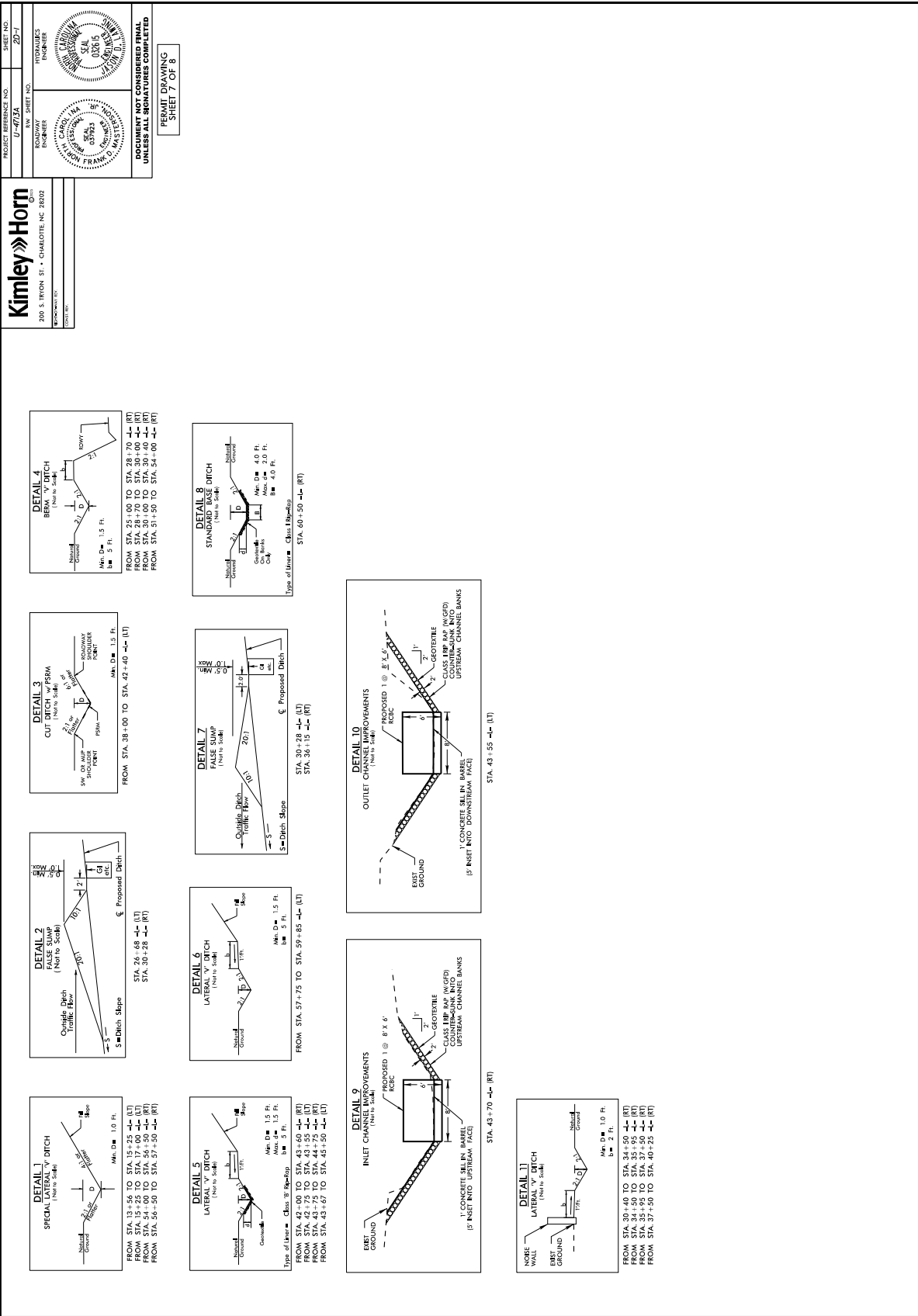

PROJECT REFERENCE NO. **U-473A** SHEET NO. **207**

INCORPORATED ENGINEER

INCORPORATED ENGINEER

Kimley-Horn
200 S. TRYON ST. • CHARLOTTE, NC 28202
(704) 381-9800
www.kimley-horn.com

DOCUMENT NOT COVERED BY FINAL CONTRACT AGREEMENT UNLESS ALL SIGNATURES COMPLETED

DESIGN DRAWING SHEET 7 OF 8

WETLAND AND SURFACE WATER IMPACTS SUMMARY

Site No.	Station (From/To)	Structure Size / Type	WETLAND IMPACTS						SURFACE WATER IMPACTS						
			Permanent Fill In Wetlands (ac)	Temp. Fill In Wetlands (ac)	Excavation in Wetlands (ac)	Mechanized Clearing in Wetlands (ac)	Hand Clearing in Wetlands (ac)	Permanent SW impacts (ac)	Temp. SW impacts (ac)	Existing Channel Impacts Permanent (ft)	Existing Channel Impacts Temp. (ft)	Natural Stream Design (ft)			
1	43+46/43+87 -L-	8' x 6' RCBC & Fill									0.03	< 0.01	185	18	
2	59+82/60+41 -L-	60" RCP & Fill									0.01	< 0.01	155	7	
3	60+50/60+64 -L- (RT)	Standard Base Ditch									< 0.01	< 0.01	15	13	
		TOTALS*									0.05	< 0.01	355	38	0

*Rounded totals are sum of actual impacts

NOTES:

NC DEPARTMENT OF TRANSPORTATION
 DIVISION OF HIGHWAYS
 11-9-23
 MECKLENBURG COUNTY
 U-4713A
 39077.1.2
 SHEET 8 OF 8

County: MECKLENBURG

Line #	Item Number	Sec #	Description	Quantity	Unit Cost	Amount
ROADWAY ITEMS						
0001	0000100000-N	800	MOBILIZATION	Lump Sum	L.S.	
0002	0000400000-N	801	CONSTRUCTION SURVEYING	Lump Sum	L.S.	
0003	0022000000-E	225	UNCLASSIFIED EXCAVATION	39,000 CY		
0004	0050000000-E	226	SUPPLEMENTARY CLEARING & GRUBBING	2 ACR		
0005	0057000000-E	226	UNDERCUT EXCAVATION	3,600 CY		
0006	0063000000-N	SP	GRADING	Lump Sum	L.S.	
0007	0134000000-E	240	DRAINAGE DITCH EXCAVATION	630 CY		
0008	0192000000-N	260	PROOF ROLLING	10 HR		
0009	0195000000-E	265	SELECT GRANULAR MATERIAL	3,350 CY		
0010	0196000000-E	270	GEOTEXTILE FOR SOIL STABILIZATION	4,750 SY		
0011	0318000000-E	300	FOUNDATION CONDITIONING MATERIAL, MINOR STRUCTURES	656 TON		
0012	0321000000-E	300	FOUNDATION CONDITIONING GEOTEXTILE	3,122 SY		
0013	0335200000-E	305	15" DRAINAGE PIPE	1,364 LF		
0014	0335300000-E	305	18" DRAINAGE PIPE	180 LF		
0015	0335400000-E	305	24" DRAINAGE PIPE	312 LF		
0016	0414000000-E	310	60" RC PIPE CULVERTS, CLASS III	164 LF		
0017	0448200000-E	310	15" RC PIPE CULVERTS, CLASS IV	536 LF		

County: MECKLENBURG

Line #	Item Number	Sec #	Description	Quantity	Unit Cost	Amount
0018	0448300000-E	310	18" RC PIPE CULVERTS, CLASS IV	76 LF		
0019	0448400000-E	310	24" RC PIPE CULVERTS, CLASS IV	372 LF		
0020	0582000000-E	310	15" CS PIPE CULVERTS, 0.064" THICK	60 LF		
0021	0636000000-E	310	*** CS PIPE ELBOWS, ***** THICK (15", 0.064")	2 EA		
0022	0995000000-E	340	PIPE REMOVAL	219 LF		
0023	1099500000-E	505	SHALLOW UNDERCUT	1,250 CY		
0024	1099700000-E	505	CLASS IV SUBGRADE STABILIZATION	2,500 TON		
0025	1110000000-E	510	STABILIZER AGGREGATE	250 TON		
0026	1112000000-E	505	GEOTEXTILE FOR SUBGRADE STABILIZATION	21,000 SY		
0027	1121000000-E	520	AGGREGATE BASE COURSE	8,700 TON		
0028	1220000000-E	545	INCIDENTAL STONE BASE	50 TON		
0029	1297000000-E	607	MILLING ASPHALT PAVEMENT, **** DEPTH (1-1/2")	2,970 SY		
0030	1330000000-E	607	INCIDENTAL MILLING	780 SY		
0031	1491000000-E	610	ASPHALT CONC BASE COURSE, TYPE B25.0C	420 TON		
0032	1503000000-E	610	ASPHALT CONC INTERMEDIATE COURSE, TYPE I19.0C	4,260 TON		
0033	1519000000-E	610	ASPHALT CONC SURFACE COURSE, TYPE S9.5B	3,450 TON		
0034	1575000000-E	620	ASPHALT BINDER FOR PLANT MIX	455 TON		

County: MECKLENBURG

Line #	Item Number	Sec #	Description	Quantity	Unit Cost	Amount
0035	1693000000-E	654	ASPHALT PLANT MIX, PAVEMENT REPAIR	71 TON		
0036	2022000000-E	815	SUBDRAIN EXCAVATION	160 CY		
0037	2026000000-E	815	GEOTEXTILE FOR SUBSURFACE DRAINS	700 SY		
0038	2036000000-E	815	SUBDRAIN COARSE AGGREGATE	120 CY		
0039	2044000000-E	815	6" PERFORATED SUBDRAIN PIPE	700 LF		
0040	2070000000-N	815	SUBDRAIN PIPE OUTLET	2 EA		
0041	2077000000-E	815	6" OUTLET PIPE	12 LF		
0042	2190000000-N	828	TEMPORARY STEEL PLATE COVERS FOR MASONRY DRAINAGE STRUCTURE	2 EA		
0043	2220000000-E	838	REINFORCED ENDWALLS	6 CY		
0044	2286000000-N	840	MASONRY DRAINAGE STRUCTURES	36 EA		
0045	2308000000-E	840	MASONRY DRAINAGE STRUCTURES	15 LF		
0046	2364000000-N	840	FRAME WITH TWO GRATES, STD 840.16	1 EA		
0047	2366000000-N	840	FRAME WITH TWO GRATES, STD 840.24	18 EA		
0048	2374000000-N	840	FRAME WITH GRATE & HOOD, STD 840.03, TYPE ** (E)	5 EA		
0049	2374000000-N	840	FRAME WITH GRATE & HOOD, STD 840.03, TYPE ** (F)	5 EA		
0050	2374000000-N	840	FRAME WITH GRATE & HOOD, STD 840.03, TYPE ** (G)	3 EA		

County: MECKLENBURG

Line #	Item Number	Sec #	Description	Quantity	Unit Cost	Amount
0051	2396000000-N	840	FRAME WITH COVER, STD 840.54	2 EA		
0052	2535000000-E	846	*** X *** CONCRETE CURB (9" X 18")	150 LF		
0053	2542000000-E	846	1'-6" CONCRETE CURB & GUTTER	250 LF		
0054	2549000000-E	846	2'-6" CONCRETE CURB & GUTTER	3,000 LF		
0055	2580000000-E	846	CONCRETE VALLEY GUTTER	630 LF		
0056	2591000000-E	848	4" CONCRETE SIDEWALK	3,280 SY		
0057	2605000000-N	848	CONCRETE CURB RAMPS	40 EA		
0058	2612000000-E	848	6" CONCRETE DRIVEWAY	230 SY		
0059	2627000000-E	852	4" CONCRETE ISLAND COVER	40 SY		
0060	2647000000-E	852	5" MONOLITHIC CONCRETE ISLANDS (SURFACE MOUNTED)	80 SY		
0061	2738000000-E	SP	GENERIC PAVING ITEM 4" CONCRETE SHARED USE PATH	4,710 SY		
0062	2815000000-N	858	ADJUSTMENT OF DROP INLETS	1 EA		
0063	3030000000-E	862	STEEL BEAM GUARDRAIL	400 LF		
0064	3150000000-N	862	ADDITIONAL GUARDRAIL POSTS	5 EA		
0065	3210000000-N	862	GUARDRAIL END UNITS, TYPE CAT-1	2 EA		
0066	3288000000-N	862	GUARDRAIL END UNITS, TYPE TL-2	2 EA		
0067	3420000000-E	SP	GENERIC GUARDRAIL ITEM WOOD RUB RAIL	3,375 LF		

County: MECKLENBURG

Line #	Item Number	Sec #	Description	Quantity	Unit Cost	Amount
0068	3435000000-N	SP	GENERIC GUARDRAIL ITEM TEMPORARY IMPACT ATTENUATOR UNITS, TYPE TL-3	2 EA		
0069	3575000000-E	SP	GENERIC FENCING ITEM PEDESTRIAN SAFETY RAIL	320 LF		
0070	3628000000-E	876	RIP RAP, CLASS I	145 TON		
0071	3649000000-E	876	RIP RAP, CLASS B	140 TON		
0072	3656000000-E	876	GEOTEXTILE FOR DRAINAGE	2,185 SY		
0073	4025000000-E	901	CONTRACTOR FURNISHED, TYPE *** SIGN (E)	144 SF		
0074	4072000000-E	903	SUPPORTS, 3-LB STEEL U-CHANNEL	330 LF		
0075	4102000000-N	904	SIGN ERECTION, TYPE E	27 EA		
0076	4116100000-N	904	SIGN ERECTION, RELOCATE TYPE **** (GROUND MOUNTED) (E)	1 EA		
0077	4155000000-N	907	DISPOSAL OF SIGN SYSTEM, U- CHANNEL	5 EA		
0078	4400000000-E	1110	WORK ZONE SIGNS (STATIONARY)	149 SF		
0079	4410000000-E	1110	WORK ZONE SIGNS (BARRICADE MOUNTED)	72 SF		
0080	4430000000-N	1130	DRUMS	42 EA		
0081	4445000000-E	1145	BARRICADES (TYPE III)	114 LF		
0082	4447000000-E	SP	PEDESTRIAN CHANNELIZING DEVICES	1,160 LF		
0083	4455000000-N	1150	FLAGGER	8 DAY		
0084	4465000000-N	1160	TEMPORARY CRASH CUSHIONS	2 EA		

County: MECKLENBURG

Line #	Item Number	Sec #	Description	Quantity	Unit Cost	Amount
0085	4485000000-E	1170	PORTABLE CONCRETE BARRIER	360 LF		
0086	4500000000-E	1170	REMOVE AND RESET PORTABLE CONCRETE BARRIER	360 LF		
0087	4510000000-N	1190	LAW ENFORCEMENT	160 HR		
0088	4516000000-N	1180	SKINNY DRUM	5 EA		
0089	4600000000-N	SP	GENERIC TRAFFIC CONTROL ITEM AUDIBLE WARNING DEVICES	3 EA		
0090	4600000000-N	SP	GENERIC TRAFFIC CONTROL ITEM TEMPORARY CURB RAMP	2 EA		
0091	4685000000-E	1205	THERMOPLASTIC PAVEMENT MARKING LINES (4", 90 MILS)	25,430 LF		
0092	4695000000-E	1205	THERMOPLASTIC PAVEMENT MARKING LINES (8", 90 MILS)	1,170 LF		
0093	4709000000-E	1205	THERMOPLASTIC PAVEMENT MARKING LINES (24", 90 MILS)	390 LF		
0094	4725000000-E	1205	THERMOPLASTIC PAVEMENT MARKING SYMBOL (90 MILS)	26 EA		
0095	4810000000-E	1205	PAINT PAVEMENT MARKING LINES (4")	16,620 LF		
0096	4820000000-E	1205	PAINT PAVEMENT MARKING LINES (8")	250 LF		
0097	4835000000-E	1205	PAINT PAVEMENT MARKING LINES (24")	180 LF		
0098	4845000000-N	1205	PAINT PAVEMENT MARKING SYMBOL	41 EA		
0099	4850000000-E	1205	REMOVAL OF PAVEMENT MARKING LINES (4")	23,320 LF		
0100	4860000000-E	1205	REMOVAL OF PAVEMENT MARKING LINES (8")	80 LF		
0101	4870000000-E	1205	REMOVAL OF PAVEMENT MARKING LINES (24")	260 LF		

County: MECKLENBURG

Line #	Item Number	Sec #	Description	Quantity	Unit Cost	Amount
0102	4875000000-N	1205	REMOVAL OF PAVEMENT MARKING SYMBOLS & CHARACTERS	37 EA		
0103	4890000000-E	SP	GENERIC PAVEMENT MARKING ITEM YIELD LINE THERMOPLASTIC PAVEMENT MARKING (24", 90 MILS)	32 LF		
0104	5265000000-E	SP	GENERIC LIGHTING ITEM 2" PVC CONDUIT	520 LF		
0105	5325800000-E	1510	8" WATER LINE	185 LF		
0106	5326200000-E	1510	12" WATER LINE	1,069 LF		
0107	5326600000-E	1510	16" WATER LINE	5,082 LF		
0108	5329000000-E	1510	DUCTILE IRON WATER PIPE FITTINGS	16,320 LB		
0109	5540000000-E	1515	6" VALVE	8 EA		
0110	5546000000-E	1515	8" VALVE	1 EA		
0111	5558000000-E	1515	12" VALVE	3 EA		
0112	5558600000-E	1515	16" VALVE	11 EA		
0113	5606000000-E	1515	2" BLOW OFF	3 EA		
0114	5648000000-N	1515	RELOCATE WATER METER	1 EA		
0115	5649000000-N	1515	RECONNECT WATER METER	1 EA		
0116	5666000000-N	1515	FIRE HYDRANT	8 EA		
0117	5673000000-E	1515	FIRE HYDRANT LEG	82 LF		
0118	5686500000-E	1515	WATER SERVICE LINE	90 LF		

County: MECKLENBURG

Line #	Item Number	Sec #	Description	Quantity	Unit Cost	Amount
0119	5691300000-E	1520	8" SANITARY GRAVITY SEWER	484 LF		
0120	5775000000-E	1525	4' DIA UTILITY MANHOLE	5 EA		
0121	5781000000-E	1525	UTILITY MANHOLE WALL 4' DIA	43 LF		
0122	5801000000-E	1530	ABANDON 8" UTILITY PIPE	564 LF		
0123	5804000000-E	1530	ABANDON 12" UTILITY PIPE	1,023 LF		
0124	5810000000-E	1530	ABANDON 16" UTILITY PIPE	856 LF		
0125	5816000000-N	1530	ABANDON UTILITY MANHOLE	5 EA		
0126	5835800000-E	1540	18" ENCASEMENT PIPE	50 LF		
0127	5836200000-E	1540	30" ENCASEMENT PIPE	167 LF		
0128	6000000000-E	1605	TEMPORARY SILT FENCE	13,425 LF		
0129	6006000000-E	1610	STONE FOR EROSION CONTROL, CLASS A	560 TON		
0130	6009000000-E	1610	STONE FOR EROSION CONTROL, CLASS B	1,950 TON		
0131	6012000000-E	1610	SEDIMENT CONTROL STONE	1,110 TON		
0132	6015000000-E	1615	TEMPORARY MULCHING	20.5 ACR		
0133	6018000000-E	1620	SEED FOR TEMPORARY SEEDING	1,100 LB		
0134	6021000000-E	1620	FERTILIZER FOR TEMPORARY SEEDING	7.5 TON		
0135	6024000000-E	1622	TEMPORARY SLOPE DRAINS	440 LF		

County: MECKLENBURG

Line #	Item Number	Sec #	Description	Quantity	Unit Cost	Amount
0136	6029000000-E	SP	SAFETY FENCE	800 LF		
0137	6030000000-E	1630	SILT EXCAVATION	6,440 CY		
0138	6036000000-E	1631	MATTING FOR EROSION CONTROL	14,800 SY		
0139	6037000000-E	1629	COIR FIBER MAT	100 SY		
0140	6042000000-E	1632	1/4" HARDWARE CLOTH	1,760 LF		
0141	6043000000-E	1644	LOW PERMEABILITY GEOTEXTILE	1,400 SY		
0142	6045000000-E	SP	*** TEMPORARY PIPE (15")	25 LF		
0143	6045000000-E	SP	*** TEMPORARY PIPE (42")	200 LF		
0144	6046000000-E	1636	TEMPORARY PIPE FOR STREAM CROSSING	25 LF		
0145	6069000000-E	1638	STILLING BASINS	183 CY		
0146	6070000000-N	1639	SPECIAL STILLING BASINS	2 EA		
0147	6071002000-E	1642	FLOCCULANT	430 LB		
0148	6071010000-E	1642	WATTLE	600 LF		
0149	6071012000-E	1642	COIR FIBER WATTLE	20 LF		
0150	6071030000-E	1640	COIR FIBER BAFFLE	1,675 LF		
0151	6071050000-E	1644	*** SKIMMER (1-1/2")	7 EA		
0152	6084000000-E	1660	SEEDING & MULCHING	27 ACR		

County: MECKLENBURG

Line #	Item Number	Sec #	Description	Quantity	Unit Cost	Amount
0153	6087000000-E	1660	MOWING	24 ACR		
0154	6090000000-E	1661	SEED FOR REPAIR SEEDING	200 LB		
0155	6093000000-E	1661	FERTILIZER FOR REPAIR SEEDING	1 TON		
0156	6096000000-E	1662	SEED FOR SUPPLEMENTAL SEEDING	650 LB		
0157	6108000000-E	1665	FERTILIZER TOPDRESSING	19.5 TON		
0158	6111000000-E	SP	IMPERVIOUS DIKE	65 LF		
0159	6114500000-N	1667	SPECIALIZED HAND MOWING	10 MHR		
0160	6117000000-N	1675	RESPONSE FOR EROSION CONTROL	75 EA		
0161	6117500000-N	SP	CONCRETE WASHOUT STRUCTURE	2 EA		
0162	6132000000-N	SP	GENERIC EROSION CONTROL ITEM FABRIC INSERT INLET PROTECTION CLEANOUT	96 EA		
0163	6132000000-N	SP	GENERIC EROSION CONTROL ITEM FABRIC INSERT INLET PROTECTION, TYPE 2	32 EA		
0164	6141000000-E	SP	GENERIC EROSION CONTROL ITEM PERMANENT SOIL REINFORCEMENT MAT - TYPE 3	1,080 SY		
0165	7048500000-E	1705	PEDESTRIAN SIGNAL HEAD (16", 1 SECTION W/COUNTDOWN)	8 EA		
0166	7060000000-E	1705	SIGNAL CABLE	7,120 LF		
0167	7120000000-E	1705	VEHICLE SIGNAL HEAD (12", 3 SECTION)	27 EA		
0168	7132000000-E	1705	VEHICLE SIGNAL HEAD (12", 4 SECTION)	10 EA		
0169	7252000000-E	1710	MESSENGER CABLE (1/4")	1,230 LF		

County: MECKLENBURG

Line #	Item Number	Sec #	Description	Quantity	Unit Cost	Amount
0170	7279000000-E	1715	TRACER WIRE	3,921 LF		
0171	7288000000-E	1715	PAVED TRENCHING (*****) (2, 2")	55 LF		
0172	7300000000-E	1715	UNPAVED TRENCHING (*****) (2, 2")	4,899 LF		
0173	7301000000-E	1715	DIRECTIONAL DRILL (*****) (2, 2")	1,607 LF		
0174	7324000000-N	1716	JUNCTION BOX (STANDARD SIZE)	22 EA		
0175	7348000000-N	1716	JUNCTION BOX (OVER-SIZED, HEAVY DUTY)	15 EA		
0176	7360000000-N	1720	WOOD POLE	7 EA		
0177	7372000000-N	1721	GUY ASSEMBLY	14 EA		
0178	7420000000-E	1722	2" RISER WITH WEATHERHEAD	6 EA		
0179	7444000000-E	1725	INDUCTIVE LOOP SAWCUT	2,005 LF		
0180	7456100000-E	1726	LEAD-IN CABLE (14-2)	7,820 LF		
0181	7481000000-N	SP	SITE SURVEY	1 EA		
0182	7481220000-N	SP	CAMERA WITH INTERNAL LOOP EMULATOR PROCESSING UNIT	4 EA		
0183	7516000000-E	1730	COMMUNICATIONS CABLE (** FIBER) (24)	4,240 LF		
0184	7528000000-E	1730	DROP CABLE	100 LF		
0185	7540000000-N	1731	SPLICE ENCLOSURE	2 EA		
0186	7552000000-N	1731	INTERCONNECT CENTER	2 EA		

County: MECKLENBURG

Line #	Item Number	Sec #	Description	Quantity	Unit Cost	Amount
0187	7566000000-N	1733	DELINEATOR MARKER	13 EA		
0188	7576000000-N	SP	METAL STRAIN SIGNAL POLE	2 EA		
0189	7613000000-N	SP	SOIL TEST	2 EA		
0190	7614100000-E	SP	DRILLED PIER FOUNDATION	11 CY		
0191	7630000000-N	SP	METAL STRAIN POLE DESIGN	2 EA		
0192	7636000000-N	1745	SIGN FOR SIGNALS	16 EA		
0193	7642100000-N	1743	TYPE I POST WITH FOUNDATION	3 EA		
0194	7642200000-N	1743	TYPE II PEDESTAL WITH FOUNDATION	6 EA		
0195	7684000000-N	1750	SIGNAL CABINET FOUNDATION	2 EA		
0196	7696000000-N	1751	CONTROLLERS WITH CABINET (***** (2070LX, BASE MOUNTED)	2 EA		
0197	7708000000-N	1751	DETECTOR CARD (***** (2070LX)	18 EA		
0198	7901000000-N	1753	CABINET BASE EXTENDER	2 EA		
0199	7980000000-N	SP	GENERIC SIGNAL ITEM ETHERNET EDGE SWITCH	2 EA		
0200	7980000000-N	SP	GENERIC SIGNAL ITEM RELOCATE TEMPORARY CAMERA SENSOR UNIT	3 EA		

County: MECKLENBURG

Line #	Item Number	Sec #	Description	Quantity	Unit Cost	Amount
***** BEGIN SCHEDULE AA ***** ***** (5 ALTERNATES) *****						
0201 AA1	4894900000-E	SP	GENERIC PAVEMENT MARKING ITEM 10' INLAID PAVEMENT MARKINGS	140 EA		
*** OR ***						
0202 AA2	4894900000-E	SP	GENERIC PAVEMENT MARKING ITEM 10' RUMBLE SKIPS	140 EA		
*** OR ***						
0203 AA3	4895000000-N	SP	GENERIC PAVEMENT MARKING ITEM INLAID CRADLE MARKERS	140 EA		
*** OR ***						
0204 AA4	4895000000-N	SP	GENERIC PAVEMENT MARKING ITEM INLAID RAISED PAVEMENT MARKERS	140 EA		
*** OR ***						
0205 AA5	4895000000-N	SP	GENERIC PAVEMENT MARKING ITEM POLYCARBONATE H-SHAPED MARKERS	140 EA		
***** END SCHEDULE AA *****						
CULVERT ITEMS						
0206	8130000000-N	414	BOX CULVERT EXCAVATION, STA ***** (43+65.00 -L-)	Lump Sum	L.S.	
0207	8133000000-E	414	FOUNDATION CONDITIONING MATERIAL, BOX CULVERT	117 TON		
0208	8196000000-E	420	CLASS A CONCRETE (CULVERT)	136.6 CY		
0209	8245000000-E	425	REINFORCING STEEL (CULVERT)	24,713 LB		
WALL ITEMS						
0210	8847000000-E	SP	GENERIC RETAINING WALL ITEM ARCHITECTURAL SURFACE TREATMENT (SOUND BARRIER WALL)	16,101 SF		
0211	8847000000-E	SP	GENERIC RETAINING WALL ITEM SOUND BARRIER WALL	9,580 SF		

Vendor 1 of 6: NJR GROUP INC (16044) Call Order 007 (Proposal: C204966)

Bid Information

Proposal County: MECKLENBURG	Bid Checksum: DEF93ED0B1
Vendor Address: P.O. Box 924 ALBEMARLE , NC , 28002	Bid Total: \$10,749,727.90
Signature Check: Nathaniel James Russell	Items Total: \$10,749,727.90
Time Bid Received: October 15, 2024 01:58 PM	Time Total: \$0.00
Amendment Count: 0	

Bidding Errors:
None.

DBE GOAL SET: 6%
DBE GOAL OBT: 6.11%

Vendor 1 of 6: NJR GROUP INC (16044)
Call Order 007 (Proposal: C204966)

Bid Bond Information

Projects:	Bond Maximum:
Counties:	State of Incorporation: CT
Bond ID: EC28-7FAC-DEC0-0379	Agency Execution Date: 2024-10-15T00:00:00
Paid by Check: No	Surety Name: Tinubu Surety
Bond Percent: 5%	Bond Agency Name: Travelers Casualty and Surety Company of America

DBE Load Information

Letting ID: L241015
Letting Date: 10/15/2024
Call Order: 007
Contract ID: C204966

DBE GOAL SET: 6%
DBE GOAL OBT: 6.11%

Project: STATE FUNDEDSTATE FUNDEDSTATE FUNDEDSTATE FUNDED
Bid Total: \$10,749,727.90
DBE Goal: 6.00% (\$644,983.67)

Vendor ID: 16044
Vendor Name: NJR Group Inc
DBE Entered: 6.11% (\$656,696.44)

Vendor ID	DBE Name	Is Supplier?	City/State	Goods/Service	Amount
19787	BLACK BROTHERS CONCRETE LLC	False	13014 REDWIND DR CHARLOTTE, NC 28278	SubContractor Committed	647,305.50
12578	LOPEZ REBAR LLC	False	2641 EVA DRIVE NW CONCORD, NC 28027	SubContractor Committed	9,390.94

BondID: EC28-7FAC-DEC0-0379

Surety Registry Agency: Tinubu Surety

Verified?: 1

Surety Agency: Travelers Casualty and Surety Company of America

Bond Execution Date: 2024-10-15T00:00:00

Line Number	Item Number	Quantity	Unit	Unit Price	Extension Price
Section 0001 ROADWAY ITEMS					
0001	0000100000-N MOBILIZATION	1.000	LS	\$536,000.0000	\$536,000.00
0002	0000400000-N CONSTRUCTION SURVEYING	1.000	LS	\$128,500.0000	\$128,500.00
0003	0022000000-E UNCLASSIFIED EXCAVATION	39000.000	CY	\$8.3000	\$323,700.00
0004	0050000000-E SUPPLEMENTARY CLEARING & GRUBBING	2.000	ACR	\$10,000.0000	\$20,000.00
0005	0057000000-E UNDERCUT EXCAVATION	3600.000	CY	\$27.5000	\$99,000.00
0006	0063000000-N GRADING	1.000	LS	\$850,000.0000	\$850,000.00
0007	0134000000-E DRAINAGE DITCH EXCAVATION	630.000	CY	\$25.0000	\$15,750.00
0008	0192000000-N PROOF ROLLING	10.000	HR	\$330.0000	\$3,300.00
0009	0195000000-E SELECT GRANULAR MATERIAL	3350.000	CY	\$33.0000	\$110,550.00
0010	0196000000-E GEOTEXTILE FOR SOIL STABILIZATION	4750.000	SY	\$4.4000	\$20,900.00
0011	0318000000-E FOUNDATION CONDITIONING MATERIAL, MINOR STRUCTURES	656.000	TON	\$72.8000	\$47,756.80
0012	0321000000-E FOUNDATION CONDITIONING GEOTEXTILE	3122.000	SY	\$3.9200	\$12,238.24
0013	0335200000-E 15" DRAINAGE PIPE	1364.000	LF	\$85.0000	\$115,940.00
0014	0335300000-E 18" DRAINAGE PIPE	180.000	LF	\$112.0000	\$20,160.00
0015	0335400000-E 24" DRAINAGE PIPE	312.000	LF	\$151.2000	\$47,174.40
0016	0414000000-E 60" RC PIPE CULVERTS, CLASS III	164.000	LF	\$616.0000	\$101,024.00
0017	0448200000-E 15" RC PIPE CULVERTS, CLASS IV	536.000	LF	\$106.4000	\$57,030.40
0018	0448300000-E 18" RC PIPE CULVERTS, CLASS IV	76.000	LF	\$123.2000	\$9,363.20
0019	0448400000-E 24" RC PIPE CULVERTS, CLASS IV	372.000	LF	\$156.8000	\$58,329.60
0020	0582000000-E 15" CS PIPE CULVERTS, 0.064" THICK	60.000	LF	\$168.0000	\$10,080.00
0021	0636000000-E **" CS PIPE ELBOWS, ***** THICK (15", 0.064")	2.000	EA	\$1,680.0000	\$3,360.00
0022	0995000000-E PIPE REMOVAL	219.000	LF	\$44.8000	\$9,811.20
0023	1099500000-E SHALLOW UNDERCUT	1250.000	CY	\$27.5000	\$34,375.00

0024	1099700000-E	2500.000 TON	\$46.2000	\$115,500.00
	CLASS IV SUBGRADE STABILIZATION			
0025	1110000000-E	250.000 TON	\$60.0000	\$15,000.00
	STABILIZER AGGREGATE			
0026	1112000000-E	21000.000 SY	\$3.0000	\$63,000.00
	GEOTEXTILE FOR SUBGRADE STABILIZATION			
0027	1121000000-E	8700.000 TON	\$50.3400	\$437,958.00
	AGGREGATE BASE COURSE			
0028	1220000000-E	50.000 TON	\$60.0000	\$3,000.00
	INCIDENTAL STONE BASE			
0029	1297000000-E	2970.000 SY	\$6.0000	\$17,820.00
	MILLING ASPHALT PAVEMENT, ***" DEPTH (1-1/2")			
0030	1330000000-E	780.000 SY	\$25.0000	\$19,500.00
	INCIDENTAL MILLING			
0031	1491000000-E	420.000 TON	\$116.9300	\$49,110.60
	ASPHALT CONC BASE COURSE, TYPE B25.0C			
0032	1503000000-E	4260.000 TON	\$85.0100	\$362,142.60
	ASPHALT CONC INTERMEDIATE COURSE, TYPE I19.0C			
0033	1519000000-E	3450.000 TON	\$86.1400	\$297,183.00
	ASPHALT CONC SURFACE COURSE, TYPE S9.5B			
0034	1575000000-E	455.000 TON	\$685.0000	\$311,675.00
	ASPHALT BINDER FOR PLANT MIX			
0035	1693000000-E	71.000 TON	\$200.0000	\$14,200.00
	ASPHALT PLANT MIX, PAVEMENT REPAIR			
0036	2022000000-E	160.000 CY	\$49.5000	\$7,920.00
	SUBDRAIN EXCAVATION			
0037	2026000000-E	700.000 SY	\$8.8000	\$6,160.00
	GEOTEXTILE FOR SUBSURFACE DRAINS			
0038	2036000000-E	120.000 CY	\$110.0000	\$13,200.00
	SUBDRAIN COARSE AGGREGATE			
0039	2044000000-E	700.000 LF	\$38.5000	\$26,950.00
	6" PERFORATED SUBDRAIN PIPE			
0040	2070000000-N	2.000 EA	\$440.0000	\$880.00
	SUBDRAIN PIPE OUTLET			
0041	2077000000-E	12.000 LF	\$38.5000	\$462.00
	6" OUTLET PIPE			
0042	2190000000-N	2.000 EA	\$3,000.0000	\$6,000.00
	TEMPORARY STEEL PLATE COVERS FOR MASONRY DRAINAGE STRUCTURE			
0043	2220000000-E	6.000 CY	\$3,300.0000	\$19,800.00
	REINFORCED ENDWALLS			
0044	2286000000-N	36.000 EA	\$4,400.0000	\$158,400.00
	MASONRY DRAINAGE STRUCTURES			
0045	2308000000-E	15.000 LF	\$550.0000	\$8,250.00
	MASONRY DRAINAGE STRUCTURES			
0046	2364000000-N	1.000 EA	\$1,100.0000	\$1,100.00
	FRAME WITH TWO GRATES, STD 840.16			
0047	2366000000-N	18.000 EA	\$990.0000	\$17,820.00
	FRAME WITH TWO GRATES, STD 840.24			
0048	2374000000-N	5.000 EA	\$1,265.0000	\$6,325.00

FRAME WITH GRATE & HOOD, STD 840.03, TYPE ** (E)				
0049	2374000000-N	5.000 EA	\$1,276.0000	\$6,380.00
FRAME WITH GRATE & HOOD, STD 840.03, TYPE ** (F)				
0050	2374000000-N	3.000 EA	\$1,276.0000	\$3,828.00
FRAME WITH GRATE & HOOD, STD 840.03, TYPE ** (G)				
0051	2396000000-N	2.000 EA	\$880.0000	\$1,760.00
FRAME WITH COVER, STD 840.54				
0052	2535000000-E	150.000 LF	\$44.8000	\$6,720.00
*** X *** CONCRETE CURB (9" X 18")				
0053	2542000000-E	250.000 LF	\$33.6000	\$8,400.00
1'-6" CONCRETE CURB & GUTTER				
0054	2549000000-E	3000.000 LF	\$28.0000	\$84,000.00
2'-6" CONCRETE CURB & GUTTER				
0055	2580000000-E	630.000 LF	\$26.8800	\$16,934.40
CONCRETE VALLEY GUTTER				
0056	2591000000-E	3280.000 SY	\$61.9900	\$203,327.20
4" CONCRETE SIDEWALK				
0057	2605000000-N	40.000 EA	\$2,016.0000	\$80,640.00
CONCRETE CURB RAMPS				
0058	2612000000-E	230.000 SY	\$80.6400	\$18,547.20
6" CONCRETE DRIVEWAY				
0059	2627000000-E	40.000 SY	\$80.6400	\$3,225.60
4" CONCRETE ISLAND COVER				
0060	2647000000-E	80.000 SY	\$80.6400	\$6,451.20
5" MONOLITHIC CONCRETE ISLANDS (SURFACE MOUNTED)				
0061	2738000000-E	4710.000 SY	\$63.0000	\$296,730.00
GENERIC PAVING ITEM 4" CONCRETE SHARED USE PATH				
0062	2815000000-N	1.000 EA	\$2,500.0000	\$2,500.00
ADJUSTMENT OF DROP INLETS				
0063	3030000000-E	400.000 LF	\$26.8800	\$10,752.00
STEEL BEAM GUARDRAIL				
0064	3150000000-N	5.000 EA	\$61.6000	\$308.00
ADDITIONAL GUARDRAIL POSTS				
0065	3210000000-N	2.000 EA	\$1,232.0000	\$2,464.00
GUARDRAIL END UNITS, TYPE CAT-1				
0066	3288000000-N	2.000 EA	\$3,808.0000	\$7,616.00
GUARDRAIL END UNITS, TYPE TL-2				
0067	3420000000-E	3375.000 LF	\$12.8800	\$43,470.00
GENERIC GUARDRAIL ITEM WOOD RUB RAIL				
0068	3435000000-N	2.000 EA	\$4,760.0000	\$9,520.00
GENERIC GUARDRAIL ITEM TEMPORARY IMPACT ATTENUATOR UNITS, TYPE TL-3				
0069	3575000000-E	320.000 LF	\$268.8000	\$86,016.00
GENERIC FENCING ITEM PEDESTRIAN SAFETY RAIL				
0070	3628000000-E	145.000 TON	\$70.0000	\$10,150.00
RIP RAP, CLASS I				
0071	3649000000-E	140.000 TON	\$70.0000	\$9,800.00
RIP RAP, CLASS B				
0072	3656000000-E	2185.000 SY	\$4.0000	\$8,740.00
GEOTEXTILE FOR DRAINAGE				

0073	4025000000-E	144.000	SF	\$18.2000	\$2,620.80
	CONTRACTOR FURNISHED, TYPE *** SIGN (E)				
0074	4072000000-E	330.000	LF	\$11.1900	\$3,692.70
	SUPPORTS, 3-LB STEEL U-CHANNEL				
0075	4102000000-N	27.000	EA	\$106.4000	\$2,872.80
	SIGN ERECTION, TYPE E				
0076	4116100000-N	1.000	EA	\$207.2000	\$207.20
	SIGN ERECTION, RELOCATE TYPE **** (GROUND MOUNTED) (E)				
0077	4155000000-N	5.000	EA	\$22.4000	\$112.00
	DISPOSAL OF SIGN SYSTEM, U-CHANNEL				
0078	4400000000-E	149.000	SF	\$12.3200	\$1,835.68
	WORK ZONE SIGNS (STATIONARY)				
0079	4410000000-E	72.000	SF	\$7.2800	\$524.16
	WORK ZONE SIGNS (BARRICADE MOUNTED)				
0080	4430000000-N	42.000	EA	\$22.3900	\$940.38
	DRUMS				
0081	4445000000-E	114.000	LF	\$22.3900	\$2,552.46
	BARRICADES (TYPE III)				
0082	4447000000-E	1160.000	LF	\$20.0000	\$23,200.00
	PEDESTRIAN CHANNELIZING DEVICES				
0083	4455000000-N	8.000	DAY	\$500.0000	\$4,000.00
	FLAGGER				
0084	4465000000-N	2.000	EA	\$4,200.0000	\$8,400.00
	TEMPORARY CRASH CUSHIONS				
0085	4485000000-E	360.000	LF	\$65.0000	\$23,400.00
	PORTABLE CONCRETE BARRIER				
0086	4500000000-E	360.000	LF	\$20.0000	\$7,200.00
	REMOVE AND RESET PORTABLE CONCRETE BARRIER				
0087	4510000000-N	160.000	HR	\$85.0000	\$13,600.00
	LAW ENFORCEMENT				
0088	4516000000-N	5.000	EA	\$40.0000	\$200.00
	SKINNY DRUM				
0089	4600000000-N	3.000	EA	\$500.0000	\$1,500.00
	GENERIC TRAFFIC CONTROL ITEM AUDIBLE WARNING DEVICES				
0090	4600000000-N	2.000	EA	\$500.0000	\$1,000.00
	GENERIC TRAFFIC CONTROL ITEM TEMPORARY CURB RAMP				
0091	4685000000-E	25430.000	LF	\$0.7600	\$19,326.80
	THERMOPLASTIC PAVEMENT MARKING LINES (4", 90 MILS)				
0092	4695000000-E	1170.000	LF	\$2.7400	\$3,205.80
	THERMOPLASTIC PAVEMENT MARKING LINES (8", 90 MILS)				
0093	4709000000-E	390.000	LF	\$11.7600	\$4,586.40
	THERMOPLASTIC PAVEMENT MARKING LINES (24", 90 MILS)				
0094	4725000000-E	26.000	EA	\$140.0000	\$3,640.00
	THERMOPLASTIC PAVEMENT MARKING SYMBOL (90 MILS)				
0095	4810000000-E	16620.000	LF	\$0.4000	\$6,648.00
	PAINT PAVEMENT MARKING LINES (4")				
0096	4820000000-E	250.000	LF	\$0.8400	\$210.00
	PAINT PAVEMENT MARKING LINES (8")				
0097	4835000000-E	180.000	LF	\$5.6000	\$1,008.00

PAINT PAVEMENT MARKING LINES (24")

0098	4845000000-N	41.000 EA	\$56.0000	\$2,296.00
	PAINT PAVEMENT MARKING SYMBOL			
0099	4850000000-E	23320.000 LF	\$0.4000	\$9,328.00
	REMOVAL OF PAVEMENT MARKING LINES (4")			
0100	4860000000-E	80.000 LF	\$0.8400	\$67.20
	REMOVAL OF PAVEMENT MARKING LINES (8")			
0101	4870000000-E	260.000 LF	\$5.6000	\$1,456.00
	REMOVAL OF PAVEMENT MARKING LINES (24")			
0102	4875000000-N	37.000 EA	\$56.0000	\$2,072.00
	REMOVAL OF PAVEMENT MARKING SYMBOLS & CHARACTERS			
0103	4890000000-E	32.000 LF	\$16.8000	\$537.60
	GENERIC PAVEMENT MARKING ITEM YIELD LINE THERMOPLASTIC PAVEMENT MARKING (24", 90 MILS)			
0104	5265000000-E	520.000 LF	\$50.4000	\$26,208.00
	GENERIC LIGHTING ITEM 2" PVC CONDUIT			
0105	5325800000-E	185.000 LF	\$196.0000	\$36,260.00
	8" WATER LINE			
0106	5326200000-E	1069.000 LF	\$224.0000	\$239,456.00
	12" WATER LINE			
0107	5326600000-E	5082.000 LF	\$235.2000	\$1,195,286.40
	16" WATER LINE			
0108	5329000000-E	16320.000 LB	\$11.2000	\$182,784.00
	DUCTILE IRON WATER PIPE FITTINGS			
0109	5540000000-E	8.000 EA	\$2,884.0000	\$23,072.00
	6" VALVE			
0110	5546000000-E	1.000 EA	\$4,116.0000	\$4,116.00
	8" VALVE			
0111	5558000000-E	3.000 EA	\$6,938.4000	\$20,815.20
	12" VALVE			
0112	5558600000-E	11.000 EA	\$15,680.0000	\$172,480.00
	16" VALVE			
0113	5606000000-E	3.000 EA	\$3,858.4000	\$11,575.20
	2" BLOW OFF			
0114	5648000000-N	1.000 EA	\$3,052.0000	\$3,052.00
	RELOCATE WATER METER			
0115	5649000000-N	1.000 EA	\$3,052.0000	\$3,052.00
	RECONNECT WATER METER			
0116	5666000000-N	8.000 EA	\$11,172.0000	\$89,376.00
	FIRE HYDRANT			
0117	5673000000-E	82.000 LF	\$140.0000	\$11,480.00
	FIRE HYDRANT LEG			
0118	5686500000-E	90.000 LF	\$89.6000	\$8,064.00
	WATER SERVICE LINE			
0119	5691300000-E	484.000 LF	\$308.0000	\$149,072.00
	8" SANITARY GRAVITY SEWER			
0120	5775000000-E	5.000 EA	\$7,112.0000	\$35,560.00
	4' DIA UTILITY MANHOLE			
0121	5781000000-E	43.000 LF	\$442.4000	\$19,023.20

UTILITY MANHOLE WALL 4' DIA

0122	5801000000-E	564.000	LF	\$50.4000	\$28,425.60
	ABANDON 8" UTILITY PIPE				
0123	5804000000-E	1023.000	LF	\$56.0000	\$57,288.00
	ABANDON 12" UTILITY PIPE				
0124	5810000000-E	856.000	LF	\$67.2000	\$57,523.20
	ABANDON 16" UTILITY PIPE				
0125	5816000000-N	5.000	EA	\$3,892.0000	\$19,460.00
	ABANDON UTILITY MANHOLE				
0126	5835800000-E	50.000	LF	\$442.4000	\$22,120.00
	18" ENCASEMENT PIPE				
0127	5836200000-E	167.000	LF	\$588.0000	\$98,196.00
	30" ENCASEMENT PIPE				
0128	6000000000-E	13425.000	LF	\$3.2500	\$43,631.25
	TEMPORARY SILT FENCE				
0129	6006000000-E	560.000	TON	\$70.0000	\$39,200.00
	STONE FOR EROSION CONTROL, CLASS A				
0130	6009000000-E	1950.000	TON	\$70.0000	\$136,500.00
	STONE FOR EROSION CONTROL, CLASS B				
0131	6012000000-E	1110.000	TON	\$70.0000	\$77,700.00
	SEDIMENT CONTROL STONE				
0132	6015000000-E	20.500	ACR	\$1,086.4000	\$22,271.20
	TEMPORARY MULCHING				
0133	6018000000-E	1100.000	LB	\$3.2500	\$3,575.00
	SEED FOR TEMPORARY SEEDING				
0134	6021000000-E	7.500	TON	\$1,148.0000	\$8,610.00
	FERTILIZER FOR TEMPORARY SEEDING				
0135	6024000000-E	440.000	LF	\$30.0000	\$13,200.00
	TEMPORARY SLOPE DRAINS				
0136	6029000000-E	800.000	LF	\$2.2400	\$1,792.00
	SAFETY FENCE				
0137	6030000000-E	6440.000	CY	\$18.5000	\$119,140.00
	SILT EXCAVATION				
0138	6036000000-E	14800.000	SY	\$1.5700	\$23,236.00
	MATTING FOR EROSION CONTROL				
0139	6037000000-E	100.000	SY	\$4.4800	\$448.00
	COIR FIBER MAT				
0140	6042000000-E	1760.000	LF	\$5.3200	\$9,363.20
	1/4" HARDWARE CLOTH				
0141	6043000000-E	1400.000	SY	\$5.6000	\$7,840.00
	LOW PERMEABILITY GEOTEXTILE				
0142	6045000000-E	25.000	LF	\$112.0000	\$2,800.00
	*** TEMPORARY PIPE (15")				
0143	6045000000-E	200.000	LF	\$162.4000	\$32,480.00
	*** TEMPORARY PIPE (42")				
0144	6046000000-E	25.000	LF	\$397.6000	\$9,940.00
	TEMPORARY PIPE FOR STREAM CROSSING				
0145	6069000000-E	183.000	CY	\$25.0000	\$4,575.00
	STILLING BASINS				

0146	6070000000-N	2.000	EA	\$1,120.0000	\$2,240.00
	SPECIAL STILLING BASINS				
0147	6071002000-E	430.000	LB	\$10.6400	\$4,575.20
	FLOCCULANT				
0148	6071010000-E	600.000	LF	\$9.5200	\$5,712.00
	WATTLE				
0149	6071012000-E	20.000	LF	\$11.2000	\$224.00
	COIR FIBER WATTLE				
0150	6071030000-E	1675.000	LF	\$6.7200	\$11,256.00
	COIR FIBER BAFFLE				
0151	6071050000-E	7.000	EA	\$2,240.0000	\$15,680.00
	*** SKIMMER (1-1/2")				
0152	6084000000-E	27.000	ACR	\$2,346.4000	\$63,352.80
	SEEDING & MULCHING				
0153	6087000000-E	24.000	ACR	\$168.0000	\$4,032.00
	MOWING				
0154	6090000000-E	200.000	LB	\$6.7200	\$1,344.00
	SEED FOR REPAIR SEEDING				
0155	6093000000-E	1.000	TON	\$1,568.0000	\$1,568.00
	FERTILIZER FOR REPAIR SEEDING				
0156	6096000000-E	650.000	LB	\$5.6000	\$3,640.00
	SEED FOR SUPPLEMENTAL SEEDING				
0157	6108000000-E	19.500	TON	\$1,344.0000	\$26,208.00
	FERTILIZER TOPDRESSING				
0158	6111000000-E	65.000	LF	\$85.0000	\$5,525.00
	IMPERVIOUS DIKE				
0159	6114500000-N	10.000	MHR	\$89.6000	\$896.00
	SPECIALIZED HAND MOWING				
0160	6117000000-N	75.000	EA	\$196.0000	\$14,700.00
	RESPONSE FOR EROSION CONTROL				
0161	6117500000-N	2.000	EA	\$1,250.0000	\$2,500.00
	CONCRETE WASHOUT STRUCTURE				
0162	6132000000-N	96.000	EA	\$112.0000	\$10,752.00
	GENERIC EROSION CONTROL ITEM FABRIC INSERT INLET PROTECTION CLEANOUT				
0163	6132000000-N	32.000	EA	\$168.0000	\$5,376.00
	GENERIC EROSION CONTROL ITEM FABRIC INSERT INLET PROTECTION, TYPE 2				
0164	6141000000-E	1080.000	SY	\$5.6000	\$6,048.00
	GENERIC EROSION CONTROL ITEM PERMANENT SOIL REINFORCEMENT MAT - TYPE 3				
0165	7048500000-E	8.000	EA	\$1,506.4000	\$12,051.20
	PEDESTRIAN SIGNAL HEAD (16", 1 SECTION W/COUNTDOWN)				
0166	7060000000-E	7120.000	LF	\$5.0400	\$35,884.80
	SIGNAL CABLE				
0167	7120000000-E	27.000	EA	\$1,500.8000	\$40,521.60
	VEHICLE SIGNAL HEAD (12", 3 SECTION)				
0168	7132000000-E	10.000	EA	\$1,914.0800	\$19,140.80
	VEHICLE SIGNAL HEAD (12", 4 SECTION)				
0169	7252000000-E	1230.000	LF	\$4.2600	\$5,239.80
	MESSENGER CABLE (1/4")				
0170	7279000000-E	3921.000	LF	\$1.4000	\$5,489.40

TRACER WIRE

0171	7288000000-E	55.000 LF	\$58.8000	\$3,234.00
	PAVED TRENCHING (***** (2, 2"))			
0172	7300000000-E	4899.000 LF	\$25.2000	\$123,454.80
	UNPAVED TRENCHING (***** (2, 2"))			
0173	7301000000-E	1607.000 LF	\$42.5600	\$68,393.92
	DIRECTIONAL DRILL (***** (2, 2"))			
0174	7324000000-N	22.000 EA	\$845.6000	\$18,603.20
	JUNCTION BOX (STANDARD SIZE)			
0175	7348000000-N	15.000 EA	\$1,566.8800	\$23,503.20
	JUNCTION BOX (OVER-SIZED, HEAVY DUTY)			
0176	7360000000-N	7.000 EA	\$2,884.0000	\$20,188.00
	WOOD POLE			
0177	7372000000-N	14.000 EA	\$1,031.5200	\$14,441.28
	GUY ASSEMBLY			
0178	7420000000-E	6.000 EA	\$1,232.0000	\$7,392.00
	2" RISER WITH WEATHERHEAD			
0179	7444000000-E	2005.000 LF	\$22.9600	\$46,034.80
	INDUCTIVE LOOP SAWCUT			
0180	7456100000-E	7820.000 LF	\$3.9800	\$31,123.60
	LEAD-IN CABLE (14-2)			
0181	7481000000-N	1.000 EA	\$956.4800	\$956.48
	SITE SURVEY			
0182	7481220000-N	4.000 EA	\$15,976.8000	\$63,907.20
	CAMERA WITH INTERNAL LOOP EMULATOR PROCESSING UNIT			
0183	7516000000-E	4240.000 LF	\$5.0400	\$21,369.60
	COMMUNICATIONS CABLE (** FIBER) (24)			
0184	7528000000-E	100.000 LF	\$4.5900	\$459.00
	DROP CABLE			
0185	7540000000-N	2.000 EA	\$1,893.9200	\$3,787.84
	SPLICE ENCLOSURE			
0186	7552000000-N	2.000 EA	\$2,652.1600	\$5,304.32
	INTERCONNECT CENTER			
0187	7566000000-N	13.000 EA	\$172.4800	\$2,242.24
	DELINEATOR MARKER			
0188	7576000000-N	2.000 EA	\$25,340.0000	\$50,680.00
	METAL STRAIN SIGNAL POLE			
0189	7613000000-N	2.000 EA	\$1,653.1200	\$3,306.24
	SOIL TEST			
0190	7614100000-E	11.000 CY	\$2,213.1200	\$24,344.32
	DRILLED PIER FOUNDATION			
0191	7630000000-N	2.000 EA	\$319.2000	\$638.40
	METAL STRAIN POLE DESIGN			
0192	7636000000-N	16.000 EA	\$994.5600	\$15,912.96
	SIGN FOR SIGNALS			
0193	7642100000-N	3.000 EA	\$2,889.3200	\$8,667.96
	TYPE I POST WITH FOUNDATION			
0194	7642200000-N	6.000 EA	\$4,483.3600	\$26,900.16
	TYPE II PEDESTAL WITH FOUNDATION			

0195	7684000000-N	2.000 EA	\$4,310.8800	\$8,621.76
	SIGNAL CABINET FOUNDATION			
0196	7696000000-N	2.000 EA	\$29,629.6000	\$59,259.20
	CONTROLLERS WITH CABINET (***** (2070LX, BASE MOUNTED)			
0197	7708000000-N	18.000 EA	\$396.4800	\$7,136.64
	DETECTOR CARD (***** (2070LX)			
0198	7901000000-N	2.000 EA	\$573.4400	\$1,146.88
	CABINET BASE EXTENDER			
0199	7980000000-N	2.000 EA	\$3,444.0000	\$6,888.00
	GENERIC SIGNAL ITEM ETHERNET EDGE SWITCH			
0200	7980000000-N	3.000 EA	\$1,416.8000	\$4,250.40
	GENERIC SIGNAL ITEM RELOCATE TEMPORARY CAMERA SENSOR UNIT			
0201	4894900000-E	140.000 EA		
AA1	GENERIC PAVEMENT MARKING ITEM 10' INLAID PAVEMENT MARKINGS			
0202	4894900000-E	140.000 EA		
AA2	GENERIC PAVEMENT MARKING ITEM 10' RUMBLE SKIPS			
0203	4895000000-N	140.000 EA		
AA3	GENERIC PAVEMENT MARKING ITEM INLAID CRADLE MARKERS			
0204	4895000000-N	140.000 EA		
AA4	GENERIC PAVEMENT MARKING ITEM INLAID RAISED PAVEMENT MARKERS			
0205	4895000000-N	140.000 EA	\$87.3600	\$12,230.40
AA5	GENERIC PAVEMENT MARKING ITEM POLYCARBONATE H-SHAPED MARKERS			
Section 0001 Total				\$9,752,600.47

Section 0002
CULVERT ITEMS

0206	8130000000-N	1.000 LS	\$55,000.0000	\$55,000.00
	BOX CULVERT EXCAVATION, STA ***** (43+65.00 -L-)			
0207	8133000000-E	117.000 TON	\$71.5000	\$8,365.50
	FOUNDATION CONDITIONING MATERIAL, BOX CULVERT			
0208	8196000000-E	136.600 CY	\$805.0000	\$109,963.00
	CLASS A CONCRETE (CULVERT)			
0209	8245000000-E	24713.000 LB	\$2.0900	\$51,650.17
	REINFORCING STEEL (CULVERT)			
Section 0002 Total				\$224,978.67

Section 0003
WALL ITEMS

0210	8847000000-E	16101.000 SF	\$4.7600	\$76,640.76
	GENERIC RETAINING WALL ITEM ARCHITECTURAL SURFACE TREATMENT (SOUND BARRIER WALL)			
0211	8847000000-E	9580.000 SF	\$72.6000	\$695,508.00
	GENERIC RETAINING WALL ITEM SOUND BARRIER WALL			
Section 0003 Total				\$772,148.76

Item Total

\$10,749,727.90

ELECTRONIC BID SUBMISSION

By submitting this bid electronically, I hereby acknowledge that all requirements included in the hard copy proposal, addendum, amendments, plans, standard specifications, supplemental specifications and special provisions are part of the bid and contract. Further, I acknowledge that I have read, understand, accept, acknowledge and agree to comply with all statements in this electronic bid.

=====

NON-COLLUSION, DEBARMENT AND GIFT BAN CERTIFICATION

The prequalified bidder declares (or certifies, verifies, or states) under penalty of perjury under the laws of the United States that neither he, nor any official, agent or employee has entered into any agreement, participated in any collusion, or otherwise taken any action which is in restraint of free competitive bidding in connection with any bid or contract, that the prequalified bidder has not been convicted of violating N.C.G.S. §133-24 within the last three years, and that the prequalified bidder intends to do the work with his own bonafide employees or subcontractors and will not bid for the benefit of another contractor.

By submitting this non-collusion, debarment and gift ban certification, the Contractor is attesting his status under penalty of perjury under the laws of the United States in accordance with the Debarment Certification attached, provided that the Debarment Certification also includes any required statements concerning exceptions that are applicable.

N.C.G.S. §133-32 and Executive Order 24 prohibit the offer to, or acceptance by, any State Employee of any gift from anyone with a contract with the State, or from any person seeking to do business with the State. By execution of any response in this procurement, you attest, for your entire organization and its employees or agents, that you are not aware that any such gift has been offered, accepted, or promised by any employees of your organization.

DEBARMENT CERTIFICATION OF PREQUALIFIED BIDDER

Conditions for certification:

1. The prequalified bidder shall provide immediate written notice to the Department if at any time the bidder learns that his certification was erroneous when he submitted his debarment certification or explanation that is file with the Department, or has become erroneous because of changed circumstances.
2. The terms covered transaction, debarred, suspended, ineligible, lower tier

covered transaction, participant, person, primary covered transaction, principal, proposal, and voluntarily excluded, as used in this provision, have the meanings set out in the Definitions and Coverage sections of the rules implementing Executive Order 12549. A copy of the Federal Rules requiring this certification and detailing the definitions and coverages may be obtained from the Contract Officer of the Department.

3. The prequalified bidder agrees by submitting this form, that he will not knowingly enter into any lower tier covered transaction with a person who is debarred, suspended, declared ineligible, or voluntarily excluded from participation in NCDOT contracts, unless authorized by the Department.

4. For Federal Aid projects, the prequalified bidder further agrees that by submitting this form he will include the Federal- Aid Provision titled Required Contract Provisions Federal-Aid Construction Contract (Form FHWA PR 1273) provided by the Department, without subsequent modification, in all lower tier covered transactions.

5. The prequalified bidder may rely upon a certification of a participant in a lower tier covered transaction that he is not debarred, suspended, ineligible, or voluntarily excluded from the covered transaction, unless he knows that the certification is erroneous. The bidder may decide the method and frequency by which he will determine the eligibility of his subcontractors.

6. Nothing contained in the foregoing shall be construed to require establishment of a system of records in order to render in good faith the certification required by this provision. The knowledge and information of a participant is not required to exceed that which is normally possessed by a prudent person in the ordinary course of business dealings.

7. Except as authorized in paragraph 6 herein, the Department may terminate any contract if the bidder knowingly enters into a lower tier covered transaction with a person who is suspended, debarred, ineligible, or voluntarily excluded from participation in this transaction, in addition to other remedies available by the Federal Government.

DEBARMENT CERTIFICATION

The prequalified bidder certifies to the best of his knowledge and belief, that he and his principals:

a. Are not presently debarred, suspended, proposed for debarment, declared ineligible, or voluntarily excluded from covered transactions by any Federal department or agency;

b. Have not within a three-year period preceding this proposal been convicted of or had a civil judgment rendered against them for commission of fraud or a criminal offense in connection with obtaining, attempting to obtain, or performing a public (Federal, State or local) transaction or contract under a public transaction; violation of Federal or State antitrust statutes or

commission of embezzlement, theft, forgery, bribery, falsification or destruction of records; making false statements; or receiving stolen property;

c. Are not presently indicted for or otherwise criminally or civilly charged by a governmental entity (Federal, State or local) with commission of any of the offenses enumerated in paragraph b. of this certification; and

d. Have not within a three-year period preceding this proposal had one or more public transactions (Federal, State or local) terminated for cause or default.

e. Will submit a revised Debarment Certification immediately if his status changes and will show in his bid proposal an explanation for the change in status.

If the prequalified bidder cannot certify that he is not debarred, he shall provide an explanation with this submittal. An explanation will not necessarily result in denial of participation in a contract.

Failure to submit a non-collusion and debarment certification will result in the prequalified bidder's bid being considered non-responsive.

EXPLANATION:

=====

Award Limits on Multiple Projects

By answering YES to this statement, the bidder acknowledges that they are using the award limits on multiple projects? **Yes** **No**

A bidder who desires to bid on more than one project on which bids are to be opened on the same date, and who also desires to avoid receiving an award of more projects than he is equipped to handle, may bid on any number of projects but may limit the total amount of work awarded to him on selected projects by completing the AWARD LIMITS ON MULTIPLE PROJECTS.

The Award Limits on Multiple Projects must be filled in on each project bid for which the Bidder desires protection.

It is the desire of the Bidder to be awarded contracts, the value of which will not exceed a total of for those projects indicated herein, for which bids will be opened on (MM/DD/YY)

The Award Limits shall apply to the following projects:

Contract Number
County

Contract Number
County

Contract Number
County

Contract Number
County

Contract Number
County

Contract Number
County

It is agreed that if I am (we are) the low Bidder(s) on indicated projects, the total value of which is more than the above stipulated award limits, the Board of Transportation will award me (us) projects from among those indicated

that have a total value not to exceed the award limit and will result in the lowest total bids to the Department of Transportation.

DBE List Summary

Project: STATE FUNDED
Bid Total: 10,749,727.90
Goal: 6.00% (644,983.67)
Total Entered: 6.11% (656,696.44)

Bidder ID: 16044
Business Name: NJR Group Inc

ID	Name	Supp?/Dist?	Item Count	Amount	Is Complete?
19787	BLACK BROTHERS CONCRETE LLC	No	10	647,305.50	True
12578	LOPEZ REBAR LLC	No	1	9,390.94	True

Name: BLACK BROTHERS CONCRETE LLC ID: 19787

Address: 13014 REDWIND DR CHARLOTTE, NC 28278

Used As: SubContractor DBE Items Total:\$647,305.50

Items for BLACK BROTHERS CONCRETE LLC

0001 ROADWAY ITEMS				
0052	2535000000-E	150.000 LF	\$40.0000	\$6,000.00
	*** X *** CONCRETE CURB (9" X 18")			
0053	2542000000-E	250.000 LF	\$30.0000	\$7,500.00
	1'-6" CONCRETE CURB & GUTTER			
0054	2549000000-E	3000.000 LF	\$25.0000	\$75,000.00
	2'-6" CONCRETE CURB & GUTTER			
0055	2580000000-E	630.000 LF	\$24.0000	\$15,120.00
	CONCRETE VALLEY GUTTER			
0056	2591000000-E	3280.000 SY	\$55.3500	\$181,548.00
	4" CONCRETE SIDEWALK			
0057	2605000000-N	40.000 EA	\$1,800.0000	\$72,000.00
	CONCRETE CURB RAMPS			
0058	2612000000-E	230.000 SY	\$72.0000	\$16,560.00
	6" CONCRETE DRIVEWAY			
0059	2627000000-E	40.000 SY	\$72.0000	\$2,880.00
	4" CONCRETE ISLAND COVER			
0060	2647000000-E	80.000 SY	\$72.0000	\$5,760.00
	5" MONOLITHIC CONCRETE ISLANDS (SURFACE MOUNTED)			
0061	2738000000-E	4710.000 SY	\$56.2500	\$264,937.50
	GENERIC PAVING ITEM 4" CONCRETE SHARED USE PATH			
Section 0001 Total				\$647,305.50
Item Total				\$647,305.50

Name: LOPEZ REBAR LLC ID: 12578

Address: 2641 EVA DRIVE NW CONCORD, NC 28027

Used As: SubContractor DBE Items Total:\$9,390.94

Items for LOPEZ REBAR LLC

0002				
CULVERT ITEMS				
0209	8245000000-E	24713.000 LB	\$0.3800	\$9,390.94
	REINFORCING STEEL (CULVERT)			
Section 0002 Total				\$9,390.94
Item Total				\$9,390.94

THIS PROPOSAL CONTAINS THE FOLLOWING ERRORS/WARNINGS (IF ANY)

This Bid contains 0 amendment files

Electronic Bid Submission

By submitting this bid electronically, I hereby acknowledge that all requirements included in the hard copy proposal, addendum, amendments, plans, standard specifications, supplemental specifications and special provisions are part of the bid and contract. Further, I acknowledge that I have read, understand, accept, acknowledge and agree to comply with all statements in this electronic bid.

I hereby certify that I have the authority to submit this bid.

Signature _____

Agency _____

Date _____

Signature _____

Agency _____

Date _____

Signature _____

Agency _____

Date _____

Attachments

Failure to complete and attach the Fuel Usage Factor Adjustment Form will result in using 2.90 gallons per ton as the Fuel Usage Factor for Diesel for the asphalt items included on the form. The contractor will not be permitted to change the option after the bids are submitted.

NOTE: The maximum upload limit is 5 MB.

Verify

Line #	ItemNumber	Sec #	Description	Quantity Unit	Unit Bid Price	Amount Bid
ROADWAY ITEMS						
0001	0000100000-N	800	MOBILIZATION	LUMP SUM	536,000.00	536,000.00
0002	0000400000-N	801	CONSTRUCTION SURVEYING	LUMP SUM	128,500.00	128,500.00
0003	0022000000-E	225	UNCLASSIFIED EXCAVATION	39,000 CY	8.30	323,700.00
0004	0050000000-E	226	SUPPLEMENTARY CLEARING & GRUBBING	2 ACR	10,000.00	20,000.00
0005	0057000000-E	226	UNDERCUT EXCAVATION	3,600 CY	27.50	99,000.00
0006	0063000000-N	SP	GRADING	LUMP SUM	850,000.00	850,000.00
0007	0134000000-E	240	DRAINAGE DITCH EXCAVATION	630 CY	25.00	15,750.00
0008	0192000000-N	260	PROOF ROLLING	10 HR	330.00	3,300.00
0009	0195000000-E	265	SELECT GRANULAR MATERIAL	3,350 CY	33.00	110,550.00
0010	0196000000-E	270	GEOTEXTILE FOR SOIL STABILIZATION	4,750 SY	4.40	20,900.00
0011	0318000000-E	300	FOUNDATION CONDITIONING MATERIAL, MINOR STRUCTURES	656 TON	72.80	47,756.80
0012	0321000000-E	300	FOUNDATION CONDITIONING GEOTEXTILE	3,122 SY	3.92	12,238.24
0013	0335200000-E	305	15" DRAINAGE PIPE	1,364 LF	85.00	115,940.00
0014	0335300000-E	305	18" DRAINAGE PIPE	180 LF	112.00	20,160.00
0015	0335400000-E	305	24" DRAINAGE PIPE	312 LF	151.20	47,174.40
0016	0414000000-E	310	60" RC PIPE CULVERTS, CLASS III	164 LF	616.00	101,024.00
0017	0448200000-E	310	15" RC PIPE CULVERTS, CLASS IV	536 LF	106.40	57,030.40
0018	0448300000-E	310	18" RC PIPE CULVERTS, CLASS IV	76 LF	123.20	9,363.20
0019	0448400000-E	310	24" RC PIPE CULVERTS, CLASS IV	372 LF	156.80	58,329.60
0020	0582000000-E	310	15" CS PIPE CULVERTS, 0.064" THICK	60 LF	168.00	10,080.00
0021	0636000000-E	310	*** CS PIPE ELBOWS, ***** THICK (15", 0.064")	2 EA	1,680.00	3,360.00
0022	0995000000-E	340	PIPE REMOVAL	219 LF	44.80	9,811.20

Line #	ItemNumber	Sec #	Description	Quantity Unit	Unit Bid Price	Amount Bid
0023	1099500000-E	505	SHALLOW UNDERCUT	1,250 CY	27.50	34,375.00
0024	1099700000-E	505	CLASS IV SUBGRADE STABILIZATION	2,500 TON	46.20	115,500.00
0025	1110000000-E	510	STABILIZER AGGREGATE	250 TON	60.00	15,000.00
0026	1112000000-E	505	GEOTEXTILE FOR SUBGRADE STABILIZATION	21,000 SY	3.00	63,000.00
0027	1121000000-E	520	AGGREGATE BASE COURSE	8,700 TON	50.34	437,958.00
0028	1220000000-E	545	INCIDENTAL STONE BASE	50 TON	60.00	3,000.00
0029	1297000000-E	607	MILLING ASPHALT PAVEMENT, **** DEPTH (1-1/2")	2,970 SY	6.00	17,820.00
0030	1330000000-E	607	INCIDENTAL MILLING	780 SY	25.00	19,500.00
0031	1491000000-E	610	ASPHALT CONC BASE COURSE, TYPE B25.0C	420 TON	116.93	49,110.60
0032	1503000000-E	610	ASPHALT CONC INTERMEDIATE COURSE, TYPE I19.0C	4,260 TON	85.01	362,142.60
0033	1519000000-E	610	ASPHALT CONC SURFACE COURSE, TYPE S9.5B	3,450 TON	86.14	297,183.00
0034	1575000000-E	620	ASPHALT BINDER FOR PLANT MIX	455 TON	685.00	311,675.00
0035	1693000000-E	654	ASPHALT PLANT MIX, PAVEMENT REPAIR	71 TON	200.00	14,200.00
0036	2022000000-E	815	SUBDRAIN EXCAVATION	160 CY	49.50	7,920.00
0037	2026000000-E	815	GEOTEXTILE FOR SUBSURFACE DRAINS	700 SY	8.80	6,160.00
0038	2036000000-E	815	SUBDRAIN COARSE AGGREGATE	120 CY	110.00	13,200.00
0039	2044000000-E	815	6" PERFORATED SUBDRAIN PIPE	700 LF	38.50	26,950.00
0040	2070000000-N	815	SUBDRAIN PIPE OUTLET	2 EA	440.00	880.00
0041	2077000000-E	815	6" OUTLET PIPE	12 LF	38.50	462.00
0042	2190000000-N	828	TEMPORARY STEEL PLATE COVERS FOR MASONRY DRAINAGE STRUCTURE	2 EA	3,000.00	6,000.00
0043	2220000000-E	838	REINFORCED ENDWALLS	6 CY	3,300.00	19,800.00
0044	2286000000-N	840	MASONRY DRAINAGE STRUCTURES	36 EA	4,400.00	158,400.00

Line #	ItemNumber	Sec #	Description	Quantity Unit	Unit Bid Price	Amount Bid
0045	2308000000-E	840	MASONRY DRAINAGE STRUCTURES	15 LF	550.00	8,250.00
0046	2364000000-N	840	FRAME WITH TWO GRATES, STD 840.16	1 EA	1,100.00	1,100.00
0047	2366000000-N	840	FRAME WITH TWO GRATES, STD 840.24	18 EA	990.00	17,820.00
0048	2374000000-N	840	FRAME WITH GRATE & HOOD, STD 840.03, TYPE ** (E)	5 EA	1,265.00	6,325.00
0049	2374000000-N	840	FRAME WITH GRATE & HOOD, STD 840.03, TYPE ** (F)	5 EA	1,276.00	6,380.00
0050	2374000000-N	840	FRAME WITH GRATE & HOOD, STD 840.03, TYPE ** (G)	3 EA	1,276.00	3,828.00
0051	2396000000-N	840	FRAME WITH COVER, STD 840.54	2 EA	880.00	1,760.00
0052	2535000000-E	846	*** X *** CONCRETE CURB (9" X 18")	150 LF	44.80	6,720.00
0053	2542000000-E	846	1'-6" CONCRETE CURB & GUTTER	250 LF	33.60	8,400.00
0054	2549000000-E	846	2'-6" CONCRETE CURB & GUTTER	3,000 LF	28.00	84,000.00
0055	2580000000-E	846	CONCRETE VALLEY GUTTER	630 LF	26.88	16,934.40
0056	2591000000-E	848	4" CONCRETE SIDEWALK	3,280 SY	61.99	203,327.20
0057	2605000000-N	848	CONCRETE CURB RAMPS	40 EA	2,016.00	80,640.00
0058	2612000000-E	848	6" CONCRETE DRIVEWAY	230 SY	80.64	18,547.20
0059	2627000000-E	852	4" CONCRETE ISLAND COVER	40 SY	80.64	3,225.60
0060	2647000000-E	852	5" MONOLITHIC CONCRETE ISLANDS (SURFACE MOUNTED)	80 SY	80.64	6,451.20
0061	2738000000-E	SP	GENERIC PAVING ITEM 4" CONCRETE SHARED USE PATH	4,710 SY	63.00	296,730.00
0062	2815000000-N	858	ADJUSTMENT OF DROP INLETS	1 EA	2,500.00	2,500.00
0063	3030000000-E	862	STEEL BEAM GUARDRAIL	400 LF	26.88	10,752.00
0064	3150000000-N	862	ADDITIONAL GUARDRAIL POSTS	5 EA	61.60	308.00
0065	3210000000-N	862	GUARDRAIL END UNITS, TYPE CAT-1	2 EA	1,232.00	2,464.00

Line #	ItemNumber	Sec #	Description	Quantity Unit	Unit Bid Price	Amount Bid
0066	3288000000-N	862	GUARDRAIL END UNITS, TYPE TL-2	2 EA	3,808.00	7,616.00
0067	3420000000-E	SP	GENERIC GUARDRAIL ITEM WOOD RUB RAIL	3,375 LF	12.88	43,470.00
0068	3435000000-N	SP	GENERIC GUARDRAIL ITEM TEMPORARY IMPACT ATTENUATOR UNITS, TYPE TL-3	2 EA	4,760.00	9,520.00
0069	3575000000-E	SP	GENERIC FENCING ITEM PEDESTRIAN SAFETY RAIL	320 LF	268.80	86,016.00
0070	3628000000-E	876	RIP RAP, CLASS I	145 TON	70.00	10,150.00
0071	3649000000-E	876	RIP RAP, CLASS B	140 TON	70.00	9,800.00
0072	3656000000-E	876	GEOTEXTILE FOR DRAINAGE	2,185 SY	4.00	8,740.00
0073	4025000000-E	901	CONTRACTOR FURNISHED, TYPE *** SIGN (E)	144 SF	18.20	2,620.80
0074	4072000000-E	903	SUPPORTS, 3-LB STEEL U-CHANNEL	330 LF	11.19	3,692.70
0075	4102000000-N	904	SIGN ERECTION, TYPE E	27 EA	106.40	2,872.80
0076	4116100000-N	904	SIGN ERECTION, RELOCATE TYPE **** (GROUND MOUNTED) (E)	1 EA	207.20	207.20
0077	4155000000-N	907	DISPOSAL OF SIGN SYSTEM, U- CHANNEL	5 EA	22.40	112.00
0078	4400000000-E	1110	WORK ZONE SIGNS (STATIONARY)	149 SF	12.32	1,835.68
0079	4410000000-E	1110	WORK ZONE SIGNS (BARRICADE MOUNTED)	72 SF	7.28	524.16
0080	4430000000-N	1130	DRUMS	42 EA	22.39	940.38
0081	4445000000-E	1145	BARRICADES (TYPE III)	114 LF	22.39	2,552.46
0082	4447000000-E	SP	PEDESTRIAN CHANNELIZING DEVICES	1,160 LF	20.00	23,200.00
0083	4455000000-N	1150	FLAGGER	8 DAY	500.00	4,000.00
0084	4465000000-N	1160	TEMPORARY CRASH CUSHIONS	2 EA	4,200.00	8,400.00
0085	4485000000-E	1170	PORTABLE CONCRETE BARRIER	360 LF	65.00	23,400.00
0086	4500000000-E	1170	REMOVE AND RESET PORTABLE CONCRETE BARRIER	360 LF	20.00	7,200.00

Line #	ItemNumber	Sec #	Description	Quantity Unit	Unit Bid Price	Amount Bid
0087	4510000000-N	1190	LAW ENFORCEMENT	160 HR	85.00	13,600.00
0088	4516000000-N	1180	SKINNY DRUM	5 EA	40.00	200.00
0089	4600000000-N	SP	GENERIC TRAFFIC CONTROL ITEM AUDIBLE WARNING DEVICES	3 EA	500.00	1,500.00
0090	4600000000-N	SP	GENERIC TRAFFIC CONTROL ITEM TEMPORARY CURB RAMP	2 EA	500.00	1,000.00
0091	4685000000-E	1205	THERMOPLASTIC PAVEMENT MARKING LINES (4", 90 MILS)	25,430 LF	0.76	19,326.80
0092	4695000000-E	1205	THERMOPLASTIC PAVEMENT MARKING LINES (8", 90 MILS)	1,170 LF	2.74	3,205.80
0093	4709000000-E	1205	THERMOPLASTIC PAVEMENT MARKING LINES (24", 90 MILS)	390 LF	11.76	4,586.40
0094	4725000000-E	1205	THERMOPLASTIC PAVEMENT MARKING SYMBOL (90 MILS)	26 EA	140.00	3,640.00
0095	4810000000-E	1205	PAINT PAVEMENT MARKING LINES (4")	16,620 LF	0.40	6,648.00
0096	4820000000-E	1205	PAINT PAVEMENT MARKING LINES (8")	250 LF	0.84	210.00
0097	4835000000-E	1205	PAINT PAVEMENT MARKING LINES (24")	180 LF	5.60	1,008.00
0098	4845000000-N	1205	PAINT PAVEMENT MARKING SYMBOL	41 EA	56.00	2,296.00
0099	4850000000-E	1205	REMOVAL OF PAVEMENT MARKING LINES (4")	23,320 LF	0.40	9,328.00
0100	4860000000-E	1205	REMOVAL OF PAVEMENT MARKING LINES (8")	80 LF	0.84	67.20
0101	4870000000-E	1205	REMOVAL OF PAVEMENT MARKING LINES (24")	260 LF	5.60	1,456.00
0102	4875000000-N	1205	REMOVAL OF PAVEMENT MARKING SYMBOLS & CHARACTERS	37 EA	56.00	2,072.00
0103	4890000000-E	SP	GENERIC PAVEMENT MARKING ITEM YIELD LINE THERMOPLASTIC PAVEMENT MARKING (24", 90 MILS)	32 LF	16.80	537.60
0104	5265000000-E	SP	GENERIC LIGHTING ITEM 2" PVC CONDUIT	520 LF	50.40	26,208.00
0105	5325800000-E	1510	8" WATER LINE	185 LF	196.00	36,260.00
0106	5326200000-E	1510	12" WATER LINE	1,069 LF	224.00	239,456.00
0107	5326600000-E	1510	16" WATER LINE	5,082 LF	235.20	1,195,286.40
0108	5329000000-E	1510	DUCTILE IRON WATER PIPE FITTINGS	16,320 LB	11.20	182,784.00

Line #	ItemNumber	Sec #	Description	Quantity Unit	Unit Bid Price	Amount Bid
0109	5540000000-E	1515	6" VALVE	8 EA	2,884.00	23,072.00
0110	5546000000-E	1515	8" VALVE	1 EA	4,116.00	4,116.00
0111	5558000000-E	1515	12" VALVE	3 EA	6,938.40	20,815.20
0112	5558600000-E	1515	16" VALVE	11 EA	15,680.00	172,480.00
0113	5606000000-E	1515	2" BLOW OFF	3 EA	3,858.40	11,575.20
0114	5648000000-N	1515	RELOCATE WATER METER	1 EA	3,052.00	3,052.00
0115	5649000000-N	1515	RECONNECT WATER METER	1 EA	3,052.00	3,052.00
0116	5666000000-N	1515	FIRE HYDRANT	8 EA	11,172.00	89,376.00
0117	5673000000-E	1515	FIRE HYDRANT LEG	82 LF	140.00	11,480.00
0118	5686500000-E	1515	WATER SERVICE LINE	90 LF	89.60	8,064.00
0119	5691300000-E	1520	8" SANITARY GRAVITY SEWER	484 LF	308.00	149,072.00
0120	5775000000-E	1525	4' DIA UTILITY MANHOLE	5 EA	7,112.00	35,560.00
0121	5781000000-E	1525	UTILITY MANHOLE WALL 4' DIA	43 LF	442.40	19,023.20
0122	5801000000-E	1530	ABANDON 8" UTILITY PIPE	564 LF	50.40	28,425.60
0123	5804000000-E	1530	ABANDON 12" UTILITY PIPE	1,023 LF	56.00	57,288.00
0124	5810000000-E	1530	ABANDON 16" UTILITY PIPE	856 LF	67.20	57,523.20
0125	5816000000-N	1530	ABANDON UTILITY MANHOLE	5 EA	3,892.00	19,460.00
0126	5835800000-E	1540	18" ENCASMENT PIPE	50 LF	442.40	22,120.00
0127	5836200000-E	1540	30" ENCASMENT PIPE	167 LF	588.00	98,196.00
0128	6000000000-E	1605	TEMPORARY SILT FENCE	13,425 LF	3.25	43,631.25
0129	6006000000-E	1610	STONE FOR EROSION CONTROL, CLASS A	560 TON	70.00	39,200.00
0130	6009000000-E	1610	STONE FOR EROSION CONTROL, CLASS B	1,950 TON	70.00	136,500.00
0131	6012000000-E	1610	SEDIMENT CONTROL STONE	1,110 TON	70.00	77,700.00

Line #	ItemNumber	Sec #	Description	Quantity Unit	Unit Bid Price	Amount Bid
0132	6015000000-E	1615	TEMPORARY MULCHING	20.5 ACR	1,086.40	22,271.20
0133	6018000000-E	1620	SEED FOR TEMPORARY SEEDING	1,100 LB	3.25	3,575.00
0134	6021000000-E	1620	FERTILIZER FOR TEMPORARY SEEDING	7.5 TON	1,148.00	8,610.00
0135	6024000000-E	1622	TEMPORARY SLOPE DRAINS	440 LF	30.00	13,200.00
0136	6029000000-E	SP	SAFETY FENCE	800 LF	2.24	1,792.00
0137	6030000000-E	1630	SILT EXCAVATION	6,440 CY	18.50	119,140.00
0138	6036000000-E	1631	MATTING FOR EROSION CONTROL	14,800 SY	1.57	23,236.00
0139	6037000000-E	1629	COIR FIBER MAT	100 SY	4.48	448.00
0140	6042000000-E	1632	1/4" HARDWARE CLOTH	1,760 LF	5.32	9,363.20
0141	6043000000-E	1644	LOW PERMEABILITY GEOTEXTILE	1,400 SY	5.60	7,840.00
0142	6045000000-E	SP	*** TEMPORARY PIPE (15")	25 LF	112.00	2,800.00
0143	6045000000-E	SP	*** TEMPORARY PIPE (42")	200 LF	162.40	32,480.00
0144	6046000000-E	1636	TEMPORARY PIPE FOR STREAM CROSSING	25 LF	397.60	9,940.00
0145	6069000000-E	1638	STILLING BASINS	183 CY	25.00	4,575.00
0146	6070000000-N	1639	SPECIAL STILLING BASINS	2 EA	1,120.00	2,240.00
0147	6071002000-E	1642	FLOCCULANT	430 LB	10.64	4,575.20
0148	6071010000-E	1642	WATTLE	600 LF	9.52	5,712.00
0149	6071012000-E	1642	COIR FIBER WATTLE	20 LF	11.20	224.00
0150	6071030000-E	1640	COIR FIBER BAFFLE	1,675 LF	6.72	11,256.00
0151	6071050000-E	1644	*** SKIMMER (1-1/2")	7 EA	2,240.00	15,680.00
0152	6084000000-E	1660	SEEDING & MULCHING	27 ACR	2,346.40	63,352.80
0153	6087000000-E	1660	MOWING	24 ACR	168.00	4,032.00
0154	6090000000-E	1661	SEED FOR REPAIR SEEDING	200 LB	6.72	1,344.00

Line #	ItemNumber	Sec #	Description	Quantity Unit	Unit Bid Price	Amount Bid
0155	6093000000-E	1661	FERTILIZER FOR REPAIR SEEDING	1 TON	1,568.00	1,568.00
0156	6096000000-E	1662	SEED FOR SUPPLEMENTAL SEEDING	650 LB	5.60	3,640.00
0157	6108000000-E	1665	FERTILIZER TOPDRESSING	19.5 TON	1,344.00	26,208.00
0158	6111000000-E	SP	IMPERVIOUS DIKE	65 LF	85.00	5,525.00
0159	6114500000-N	1667	SPECIALIZED HAND MOWING	10 MHR	89.60	896.00
0160	6117000000-N	1675	RESPONSE FOR EROSION CONTROL	75 EA	196.00	14,700.00
0161	6117500000-N	SP	CONCRETE WASHOUT STRUCTURE	2 EA	1,250.00	2,500.00
0162	6132000000-N	SP	GENERIC EROSION CONTROL ITEM FABRIC INSERT INLET PROTECTION CLEANOUT	96 EA	112.00	10,752.00
0163	6132000000-N	SP	GENERIC EROSION CONTROL ITEM FABRIC INSERT INLET PROTECTION, TYPE 2	32 EA	168.00	5,376.00
0164	6141000000-E	SP	GENERIC EROSION CONTROL ITEM PERMANENT SOIL REINFORCEMENT MAT - TYPE 3	1,080 SY	5.60	6,048.00
0165	7048500000-E	1705	PEDESTRIAN SIGNAL HEAD (16", 1 SECTION W/COUNTDOWN)	8 EA	1,506.40	12,051.20
0166	7060000000-E	1705	SIGNAL CABLE	7,120 LF	5.04	35,884.80
0167	7120000000-E	1705	VEHICLE SIGNAL HEAD (12", 3 SECTION)	27 EA	1,500.80	40,521.60
0168	7132000000-E	1705	VEHICLE SIGNAL HEAD (12", 4 SECTION)	10 EA	1,914.08	19,140.80
0169	7252000000-E	1710	MESSENGER CABLE (1/4")	1,230 LF	4.26	5,239.80
0170	7279000000-E	1715	TRACER WIRE	3,921 LF	1.40	5,489.40
0171	7288000000-E	1715	PAVED TRENCHING (***** (2, 2")	55 LF	58.80	3,234.00
0172	7300000000-E	1715	UNPAVED TRENCHING (***** (2, 2")	4,899 LF	25.20	123,454.80
0173	7301000000-E	1715	DIRECTIONAL DRILL (***** (2, 2")	1,607 LF	42.56	68,393.92
0174	7324000000-N	1716	JUNCTION BOX (STANDARD SIZE)	22 EA	845.60	18,603.20
0175	7348000000-N	1716	JUNCTION BOX (OVER-SIZED, HEAVY DUTY)	15 EA	1,566.88	23,503.20

Line #	ItemNumber	Sec #	Description	Quantity Unit	Unit Bid Price	Amount Bid
0176	7360000000-N	1720	WOOD POLE	7 EA	2,884.00	20,188.00
0177	7372000000-N	1721	GUY ASSEMBLY	14 EA	1,031.52	14,441.28
0178	7420000000-E	1722	2" RISER WITH WEATHERHEAD	6 EA	1,232.00	7,392.00
0179	7444000000-E	1725	INDUCTIVE LOOP SAWCUT	2,005 LF	22.96	46,034.80
0180	7456100000-E	1726	LEAD-IN CABLE (14-2)	7,820 LF	3.98	31,123.60
0181	7481000000-N	SP	SITE SURVEY	1 EA	956.48	956.48
0182	7481220000-N	SP	CAMERA WITH INTERNAL LOOP EMULATOR PROCESSING UNIT	4 EA	15,976.80	63,907.20
0183	7516000000-E	1730	COMMUNICATIONS CABLE (** FIBER) (24)	4,240 LF	5.04	21,369.60
0184	7528000000-E	1730	DROP CABLE	100 LF	4.59	459.00
0185	7540000000-N	1731	SPLICE ENCLOSURE	2 EA	1,893.92	3,787.84
0186	7552000000-N	1731	INTERCONNECT CENTER	2 EA	2,652.16	5,304.32
0187	7566000000-N	1733	DELINEATOR MARKER	13 EA	172.48	2,242.24
0188	7576000000-N	SP	METAL STRAIN SIGNAL POLE	2 EA	25,340.00	50,680.00
0189	7613000000-N	SP	SOIL TEST	2 EA	1,653.12	3,306.24
0190	7614100000-E	SP	DRILLED PIER FOUNDATION	11 CY	2,213.12	24,344.32
0191	7630000000-N	SP	METAL STRAIN POLE DESIGN	2 EA	319.20	638.40
0192	7636000000-N	1745	SIGN FOR SIGNALS	16 EA	994.56	15,912.96
0193	7642100000-N	1743	TYPE I POST WITH FOUNDATION	3 EA	2,889.32	8,667.96
0194	7642200000-N	1743	TYPE II PEDESTAL WITH FOUNDATION	6 EA	4,483.36	26,900.16
0195	7684000000-N	1750	SIGNAL CABINET FOUNDATION	2 EA	4,310.88	8,621.76
0196	7696000000-N	1751	CONTROLLERS WITH CABINET (***** (2070LX, BASE MOUNTED)	2 EA	29,629.60	59,259.20
0197	7708000000-N	1751	DETECTOR CARD (***** (2070LX)	18 EA	396.48	7,136.64

Line #	ItemNumber	Sec #	Description	Quantity Unit	Unit Bid Price	Amount Bid
0198	7901000000-N	1753	CABINET BASE EXTENDER	2 EA	573.44	1,146.88
0199	7980000000-N	SP	GENERIC SIGNAL ITEM ETHERNET EDGE SWITCH	2 EA	3,444.00	6,888.00
0200	7980000000-N	SP	GENERIC SIGNAL ITEM RELOCATE TEMPORARY CAMERA SENSOR UNIT	3 EA	1,416.80	4,250.40
***** BEGIN SCHEDULE AA*****						
***** (5 ALTERNATES) *****						
0201 AA1	4894900000-E	SP	GENERIC PAVEMENT MARKING ITEM 10' INLAID PAVEMENT MARKINGS	140 EA		
*** OR ***						
0202 AA2	4894900000-E	SP	GENERIC PAVEMENT MARKING ITEM 10' RUMBLE SKIPS	140 EA		
*** OR ***						
0203 AA3	4895000000-N	SP	GENERIC PAVEMENT MARKING ITEM INLAID CRADLE MARKERS	140 EA		
*** OR ***						
0204 AA4	4895000000-N	SP	GENERIC PAVEMENT MARKING ITEM INLAID RAISED PAVEMENT MARKERS	140 EA		
*** OR ***						
0205 AA5	4895000000-N	SP	GENERIC PAVEMENT MARKING ITEM POLYCARBONATE H-SHAPED MARKERS	140 EA		12,230.40
*** END SCHEDULE AA***						

Contract Item Sheets For C204966

Line #	ItemNumber	Sec #	Description	Quantity Unit	Unit Bid Price	Amount Bid
CULVERT ITEMS						
0206	813000000-N	414	BOX CULVERT EXCAVATION, STA ***** (43+65.00 -L-)	LUMP SUM	55,000.00	55,000.00
0207	813300000-E	414	FOUNDATION CONDITIONING MATERIAL, BOX CULVERT	117 TON	71.50	8,365.50
0208	819600000-E	420	CLASS A CONCRETE (CULVERT)	136.6 CY	805.00	109,963.00
0209	824500000-E	425	REINFORCING STEEL (CULVERT)	24,713 LB	2.09	51,650.17

Contract Item Sheets For C204966

Line #	ItemNumber	Sec #	Description	Quantity Unit	Unit Bid Price	Amount Bid
WALL ITEMS						
0210	8847000000-E	SP	GENERIC RETAINING WALL ITEM ARCHITECTURAL SURFACE TREATMENT (SOUND BARRIER WALL)	16,101 SF	4.76	76,640.76
0211	8847000000-E	SP	GENERIC RETAINING WALL ITEM SOUND BARRIER WALL	9,580 SF	72.60	695,508.00
TOTAL AMOUNT OF BID FOR ENTIRE PROJECT						\$10,749,727.90

Contract No. C204966
County Mecklenburg County

Rev. 8-28-23

NON-COLLUSION, DEBARMENT AND GIFT BAN CERTIFICATION

CORPORATION

The prequalified bidder, declares (or certifies, verifies, or states) under penalty of perjury under the laws of the United States that neither he, nor any official, agent or employee has entered into any agreement, participated in any collusion, or otherwise taken any action which is in restraint of free competitive bidding in connection with any bid or contract, that the prequalified bidder has not been convicted of violating *N.C.G.S. §133-24* within the last three years, and that the prequalified bidder intends to do the work with his own bona fide employees or subcontractors and will not bid for the benefit of another contractor.

By submitting this non-collusion, debarment and gift ban certification, the Contractor is attesting his status under penalty of perjury under the laws of the United States in accordance with the Debarment Certification attached, provided that the Debarment Certification also includes any required statements concerning exceptions that are applicable.

N.C.G.S. §133-32 and Executive Order 24 prohibit the offer to, or acceptance by, any State Employee of any gift from anyone with a contract with the State, or from any person seeking to do business with the State. By execution of any response in this procurement, you attest, for your entire organization and its employees or agents, that you are not aware that any such gift has been offered, accepted, or promised by any employees of your organization.

SIGNATURE OF PREQUALIFIED BIDDER

NJR GROUP, Inc.

Full name of Corporation

PO BOX 954 Albemarle, NC 28002

Address as Prequalified

Attest

Karmen O Russell
Secretary/Assistant Secretary
(Select appropriate title)

By

Nathaniel J Russell
President/Vice President/Assistant Vice President
(Select appropriate title)

Karmen O Russell

Print or Type Signer's name

Nathaniel J Russell

Print or Type Signer's name



Contract No.
County

C204966
Mecklenburg County

Rev. 8-28-23

DEBARMENT CERTIFICATION

Conditions for certification:

1. The prequalified bidder shall provide immediate written notice to the Department if at any time the bidder learns that his certification was erroneous when he submitted his debarment certification or explanation filed with the Department, or has become erroneous because of changed circumstances.
2. The terms *covered transaction*, *debarred*, *suspended*, *ineligible*, *lower tier covered transaction*, *participant*, *person*, *primary covered transaction*, *principal*, *proposal*, and *voluntarily excluded*, as used in this provision, have the meanings set out in the Definitions and Coverage sections of the rules implementing Executive Order 12549. A copy of the Federal Rules requiring this certification and detailing the definitions and coverages may be obtained from the Contract Officer of the Department.
3. The prequalified bidder agrees by submitting this form, that he will not knowingly enter into any lower tier covered transaction with a person who is debarred, suspended, declared ineligible, or voluntarily excluded from participation in NCDOT contracts, unless authorized by the Department.
4. For Federal Aid projects, the prequalified bidder further agrees that by submitting this form he will include the Federal-Aid Provision titled *Required Contract Provisions Federal-Aid Construction Contract (Form FHWA PR 1273)* provided by the Department, without subsequent modification, in all lower tier covered transactions.
5. The prequalified bidder may rely upon a certification of a participant in a lower tier covered transaction that he is not debarred, suspended, ineligible, or voluntarily excluded from the covered transaction, unless he knows that the certification is erroneous. The bidder may decide the method and frequency by which he will determine the eligibility of his subcontractors.
6. Nothing contained in the foregoing shall be construed to require establishment of a system of records in order to render in good faith the certification required by this provision. The knowledge and information of a participant is not required to exceed that which is normally possessed by a prudent person in the ordinary course of business dealings.
7. Except as authorized in paragraph 6 herein, the Department may terminate any contract if the bidder knowingly enters into a lower tier covered transaction with a person who is suspended, debarred, ineligible, or voluntarily excluded from participation in this transaction, in addition to other remedies available by the Federal Government.

DEBARMENT CERTIFICATION

The prequalified bidder certifies to the best of his knowledge and belief, that he and his principals:

- a. Are not presently debarred, suspended, proposed for debarment, declared ineligible, or voluntarily excluded from covered transactions by any Federal department or agency;
- b. Have not within a three-year period preceding this proposal been convicted of or had a civil judgment rendered against them for commission of fraud or a criminal offense in connection with obtaining, attempting to obtain, or performing a public (Federal, State or local) transaction or contract under a public transaction; violation of Federal or State antitrust statutes or commission of embezzlement, theft, forgery, bribery, falsification or destruction of records; making false statements; or receiving stolen property;
- c. Are not presently indicted for or otherwise criminally or civilly charged by a governmental entity (Federal, State or local) with commission of any of the offenses enumerated in paragraph b. of this certification; and
- d. Have not within a three-year period preceding this proposal had one or more public transactions (Federal, State or local) terminated for cause or default.
- e. Will submit a revised Debarment Certification immediately if his status changes and will show in his bid proposal an explanation for the change in status.

If the prequalified bidder cannot certify that he is not debarred, he shall provide an explanation with this submittal. An explanation will not necessarily result in denial of participation in a contract.

Failure to submit a non-collusion and debarment certification will result in the prequalified bidder's bid being considered non-responsive.

Check here if an explanation is attached to this certification.

Contract No. **C204966**

County (ies): **Mecklenburg**

ACCEPTED BY THE
DEPARTMENT OF TRANSPORTATION

Signed by:

Ronald E. Davenport, Jr.

52C46046381F443...

Contract Officer

11/04/2024

Date

Execution of Contract and Bonds
Approved as to Form:

Signed by:

Thomas H. Moore

A2E31ABDC19E410...

Attorney General

11/04/2024

Date

Contract No. C204966
County Mecklenburg

CONTRACT PAYMENT BOND

Date of Payment Bond Execution October 29, 2024

Name of Principal Contractor NJR Group, Inc.

Name of Surety: Travelers Casualty and Surety Company of America

Name of Contracting Body: **North Carolina Department of Transportation**
Raleigh, North Carolina

Amount of Bond: (\$10,749,727.90 Ten Million Seven Hundred Forty Nine Thousand Seven
Hundred Twenty Seven Dollars and 90/100

Contract ID No.: C204966

County Name: Mecklenburg

KNOW ALL MEN BY THESE PRESENTS, That we, the PRINCIPAL CONTRACTOR (hereafter, PRINCIPAL) and SURETY above named, are held and firmly bound unto the above named Contracting Body, hereinafter called the Contracting Body, in the penal sum of the amount stated above for the payment of which sum well and truly to be made, we bind ourselves, our heirs, executors, administrators, and successors, jointly and severally, firmly by these presents.

THE CONDITION OF THIS OBLIGATION IS SUCH, that whereas the principal entered into a certain contract with the Contracting Body, numbered as shown above and hereto attached:

NOW THEREFORE, if the principal shall promptly make payment to all persons supplying labor and material in the prosecution of the work provided for in said contract, and any and all duly authorized modifications of said contract that may hereafter be made, notice of which modifications to the surety being hereby waived, then this obligation to be void; otherwise to remain in full force and virtue.

IN WITNESS WHEREOF, the above-bound parties have executed this instrument under their several seals on the date indicated above, the name and corporate seal of each corporate party being hereto affixed and these presents duly signed by its undersigned representative, pursuant to authority of its governing body.

Contract No. C204966
County Mecklenburg

Rev 5-17-11

CONTRACT PAYMENT BOND

Affix Seal of Surety Company

Travelers Casualty and Surety Company of America
Print or type Surety Company Name

By Wendy E Lahm
Print, stamp or type name of Attorney-in-Fact

Wendy E Lahm
Signature of Attorney-in-Fact

Surety Phone No. 860-277-0111



H. Thomas Dawkins
Signature of Witness

H. Thomas Dawkins
Print or type Signer's name

5605 Carnegie Boulevard, Suite 300
Charlotte, NC 28209
Address of Attorney-in-Fact

Contract No. C204966
County Mecklenburg

Rev 5-17-11

**CONTRACT PAYMENT BOND
CORPORATION**

SIGNATURE OF CONTRACTOR (Principal)

NJR Group, Inc.
Full name of Corporation

1721 US 52 N, Albemarle, NC 28001
Address as prequalified

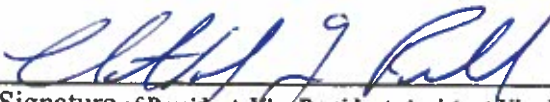
By 
Signature of President, ~~Vice President~~, Assistant ~~Vice President~~
Select appropriate title

NATHANIEL J RUSSELL
Print or type Signer's name



Attest 
Signature of Secretary, ~~Assistant Secretary~~
Select appropriate title

Karmen O Russell
Print or type Signer's name

Contract No. C204966
County Mecklenburg

CONTRACT PERFORMANCE BOND

Date of Performance Bond Execution: October 29, 2024
Name of Principal Contractor: NJR Group, Inc.
Name of Surety: Travelers Casualty and Surety Company of America
Name of Contracting Body: North Carolina Department of Transportation
Raleigh, North Carolina
Amount of Bond: (\$10,749,727.90 Ten Million Seven Hundred Forty Nine Thousand Seven
Hundred Twenty Seven Dollars and 90/100
Contract ID No.: C204966
County Name: Mecklenburg

KNOW ALL MEN BY THESE PRESENTS, That we, the PRINCIPAL CONTRACTOR (hereafter, PRINCIPAL) and SURETY above named, are held and firmly bound unto the above named Contracting Body, hereinafter called the Contracting Body, in the penal sum of the amount stated above for the payment of which sum well and truly to be made, we bind ourselves, our heirs, executors, administrators, and successors, jointly and severally, firmly by these presents.

THE CONDITION OF THIS OBLIGATION IS SUCH, that whereas the principal entered into a certain contract with the Contracting Body, numbered as shown above and hereto attached:

NOW THEREFORE, if the principal shall well and truly perform and fulfill all the undertakings, covenants, terms, conditions, and agreements of said contract during the original term of said contract and any extensions thereof that may be granted by the Contracting Body, with or without notice to the Surety, and during the life of any guaranty required under the contract, and shall also well and truly perform and fulfill all the undertakings, covenants, terms, conditions, and agreements of any and all duly authorized modifications of said contract that may hereafter be made, notice of which modifications to the surety being hereby waived, then this obligation to be void; otherwise to remain in full force and virtue.

IN WITNESS WHEREOF, the above-bound parties have executed this instrument under their several seals on the date indicated above, the name and corporate seal of each corporate party being hereto affixed and these presents duly signed by its undersigned representative, pursuant to authority of its governing body.

Contract No. C204966
County Mecklenburg

Rev 5-17-11

CONTRACT PERFORMANCE BOND

Affix Seal of Surety Company

Travelers Casualty and Surety Company of America
Print or type Surety Company Name

By Wendy E Lahm
Print, stamp or type name of Attorney-in-Fact

Signature of Attorney-in-Fact

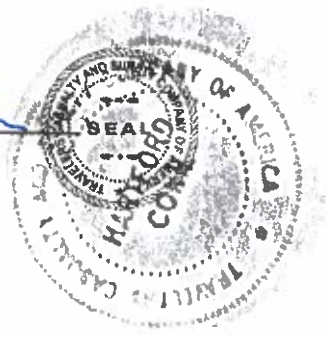

Surety Phone No. 860-277-0111

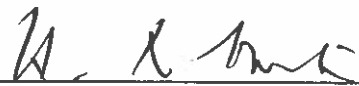
Signature of Witness

H. Thomas Dawkins
Print or type Signer's name

5605 Carnegie Boulevard, Suite 300
Charlotte, NC 28209
Address of Attorney-in-Fact

Contract No. C204966
County Mecklenburg

Rev 5-17-11

**CONTRACT PERFORMANCE BOND
CORPORATION**

SIGNATURE OF CONTRACTOR (Principal)

NJR Group, Inc.
Full name of Corporation

1721 US 52 N, Albemarle, NC 28001
Address as prequalified

By [Signature]
Signature of President, Vice President, Assistant Vice President
Select appropriate title

NATHANIEL J Russell
Print or type Signer's name



Attest [Signature]
Signature of Secretary, Assistant Secretary
Select appropriate title

Karmen O Russell
Print or type Signer's name

POWER OF ATTORNEY

Travelers Casualty and Surety Company of America, Travelers Casualty and Surety Company, St Paul Fire and Marine Insurance Company, and Farmington Casualty Company are corporations duly organized under the laws of the State of Connecticut (herein collectively called the "Companies"), and the Companies do hereby make, constitute and appoint Wendy E Lahm of Charlotte, NC, their true and lawful Attorney(s)-in-Fact to sign, execute, seal and acknowledge any and all bonds, recognizances, conditional undertakings and other writings obligatory in the nature thereof on behalf of the Companies in their business of guaranteeing the fidelity of persons, guaranteeing the performance of contracts and executing or guaranteeing bonds and undertakings required or permitted in any actions or proceedings allowed by law.

IN WITNESS WHEREOF, the Companies have caused this instrument to be signed, and their corporate seals to be hereto affixed, this 4th day of March, 2024.

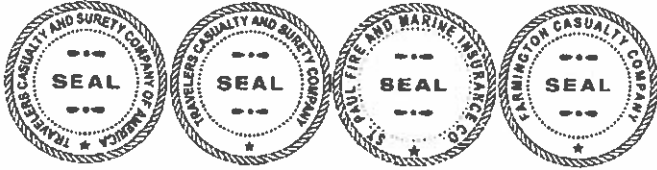

State of Connecticut

City of Hartford ss.

By: Bryce Grissom
Bryce Grissom, Senior Vice President

On this the 4th day of March, 2024, before me personally appeared Bryce Grissom, who acknowledged himself to be the Senior Vice President of each of the Companies, and that he, as such, being authorized so to do, executed the foregoing instrument for the purposes therein contained by signing on behalf of said Companies by himself as a duly authorized officer.

IN WITNESS WHEREOF, I hereunto set my hand and official seal.

My Commission expires the 30th day of June, 2026

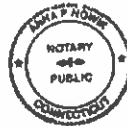

Anna P. Nowik
Anna P. Nowik, Notary Public

This Power of Attorney is granted under and by the authority of the following resolutions adopted by the Boards of Directors of each of the Companies, which resolutions are now in full force and effect, reading as follows:

RESOLVED, that the Chairman, the President, any Vice Chairman, any Executive Vice President, any Senior Vice President, any Vice President, any Second Vice President, the Treasurer, any Assistant Treasurer, the Corporate Secretary or any Assistant Secretary may appoint Attorneys-in-Fact and Agents to act for and on behalf of the Company and may give such appointee such authority as his or her certificate of authority may prescribe to sign with the Company's name and seal with the Company's seal bonds, recognizances, contracts of indemnity, and other writings obligatory in the nature of a bond, recognizance, or conditional undertaking, and any of said officers or the Board of Directors at any time may remove any such appointee and revoke the power given him or her; and it is

FURTHER RESOLVED, that the Chairman, the President, any Vice Chairman, any Executive Vice President, any Senior Vice President or any Vice President may delegate all or any part of the foregoing authority to one or more officers or employees of this Company, provided that each such delegation is in writing and a copy thereof is filed in the office of the Secretary; and it is

FURTHER RESOLVED, that any bond, recognizance, contract of indemnity, or writing obligatory in the nature of a bond, recognizance, or conditional undertaking shall be valid and binding upon the Company when (a) signed by the President, any Vice Chairman, any Executive Vice President, any Senior Vice President or any Vice President, any Second Vice President, the Treasurer, any Assistant Treasurer, the Corporate Secretary or any Assistant Secretary and duly attested and sealed with the Company's seal by a Secretary or Assistant Secretary; or (b) duly executed (under seal, if required) by one or more Attorneys-in-Fact and Agents pursuant to the power prescribed in his or her certificate or their certificates of authority or by one or more Company officers pursuant to a written delegation of authority; and it is

FURTHER RESOLVED, that the signature of each of the following officers: President, any Executive Vice President, any Senior Vice President, any Vice President, any Assistant Vice President, any Secretary, any Assistant Secretary, and the seal of the Company may be affixed by facsimile to any Power of Attorney or to any certificate relating thereto appointing Resident Vice Presidents, Resident Assistant Secretaries or Attorneys-in-Fact for purposes only of executing and attesting bonds and undertakings and other writings obligatory in the nature thereof, and any such Power of Attorney or certificate bearing such facsimile signature or facsimile seal shall be valid and binding upon the Company and any such power so executed and certified by such facsimile signature and facsimile seal shall be valid and binding on the Company in the future with respect to any bond or understanding to which it is attached.

I, Kevin E. Hughes, the undersigned, Assistant Secretary of each of the Companies, do hereby certify that the above and foregoing is a true and correct copy of the Power of Attorney executed by said Companies, which remains in full force and effect.

Dated this October 29, 2024



Kevin E. Hughes
Kevin E. Hughes, Assistant Secretary



To verify the authenticity of this Power of Attorney, please call us at 1-800-421-3880.
Please refer to the above-named Attorney(s)-in-Fact and the details of the bond to which this Power of Attorney is attached.